

The background is a complex abstract composition of overlapping geometric shapes in various colors including shades of brown, purple, blue, red, and yellow. A white spherical pendant light hangs from a thin teal cord in the upper right quadrant. The floor in the bottom right corner features a black and white checkered pattern.

*souful lighting*  
**utna**™





11



12



13



17

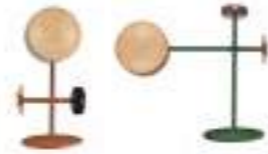

18



46



47



48



49



51



19



20



21



23



24



53



54



55



58



59



25



26



27



29



31



61



62



63



65



67



33



34



35



37



38



69



71



673



75



77



39



41



42



43



45



78



79



80



81



73





85



86



87



89



91



122



123

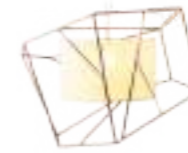

125



126



127



92



93



95



96



97



129



130



131



133



134



100



101



104



105



107



135



137



138



139



141



109



110



111



113



115



116



117



119



120



121

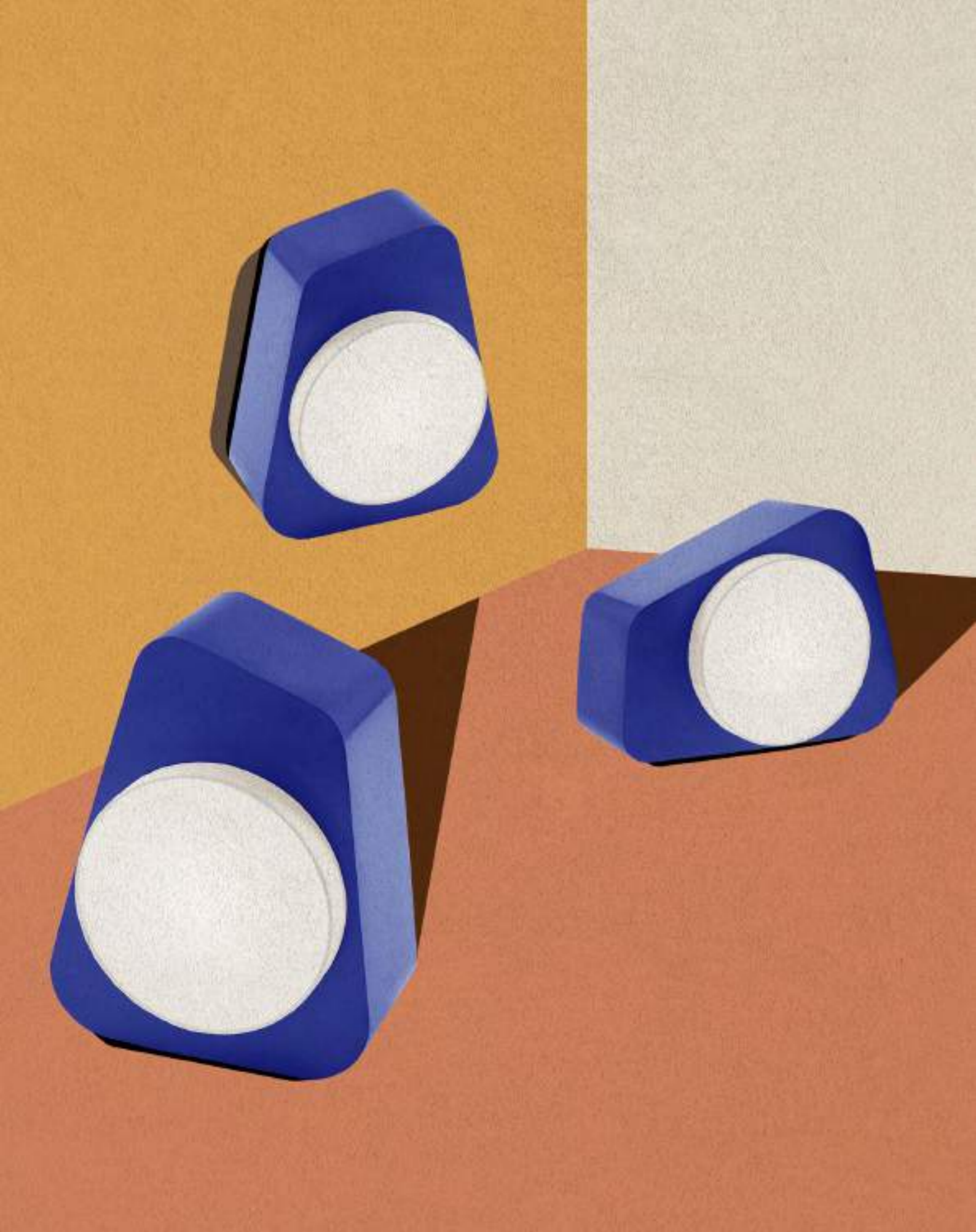

**We welcome you to our world, where creativity, quality and reliability are the guidelines.**

Lighting contributes tremendously to how one experiences spaces, as it is able to, very efficiently, influence the perception and appearance of what surrounds us, to shift sensations and feelings.

Utu soulful lighting is the response to an urge to create lighting solutions which enrich spaces with individuality and meaning.

Born from the creative hub Mambo unlimited ideas, Utu presents a versatile lighting collection, with pieces holding quite distinct characters and for different uses, including suspension, table, floor and wall lamps in a wide range of possible finishes.

We produce unique, quality products – while our work draws inspiration from every corner of the globe, it nevertheless remains rooted in local knowledge and crafts expertise. Utu’s growing international presence reflects our approach and reputation: we offer unique products and a dedicated team ready to collaborate with professionals worldwide.

A iluminação contribui tremendamente para a vivência dos ambientes, sendo capaz de influenciar a percepção e aparência do que nos rodeia, de proporcionar diferentes sensações e experiências.

A Utu soulful lighting responde ao desejo de criar peças de iluminação que enriqueçam os espaços com individualidade e significado. Nascida no seio da Mambo unlimited ideas, a Utu apresenta uma ampla coleção com diferentes conceitos e soluções funcionais, disponíveis numa interessante variedade de acabamentos.

Produzimos produtos únicos e de qualidade – recolhendo inspiração em vários cantos do planeta, não deixamos nunca de valorizar as nossas raízes de conhecimento e as nossas competências de fabrico. A crescente presença dos produtos Utu no mercado internacional reflecte a nossa abordagem e reputação: temos para oferecer produtos únicos e uma equipa pronta para colaborar com profissionais de todo o mundo.

*Bemvindo ao nosso universo, onde a criatividade, qualidade e confiança são as directrizes.*



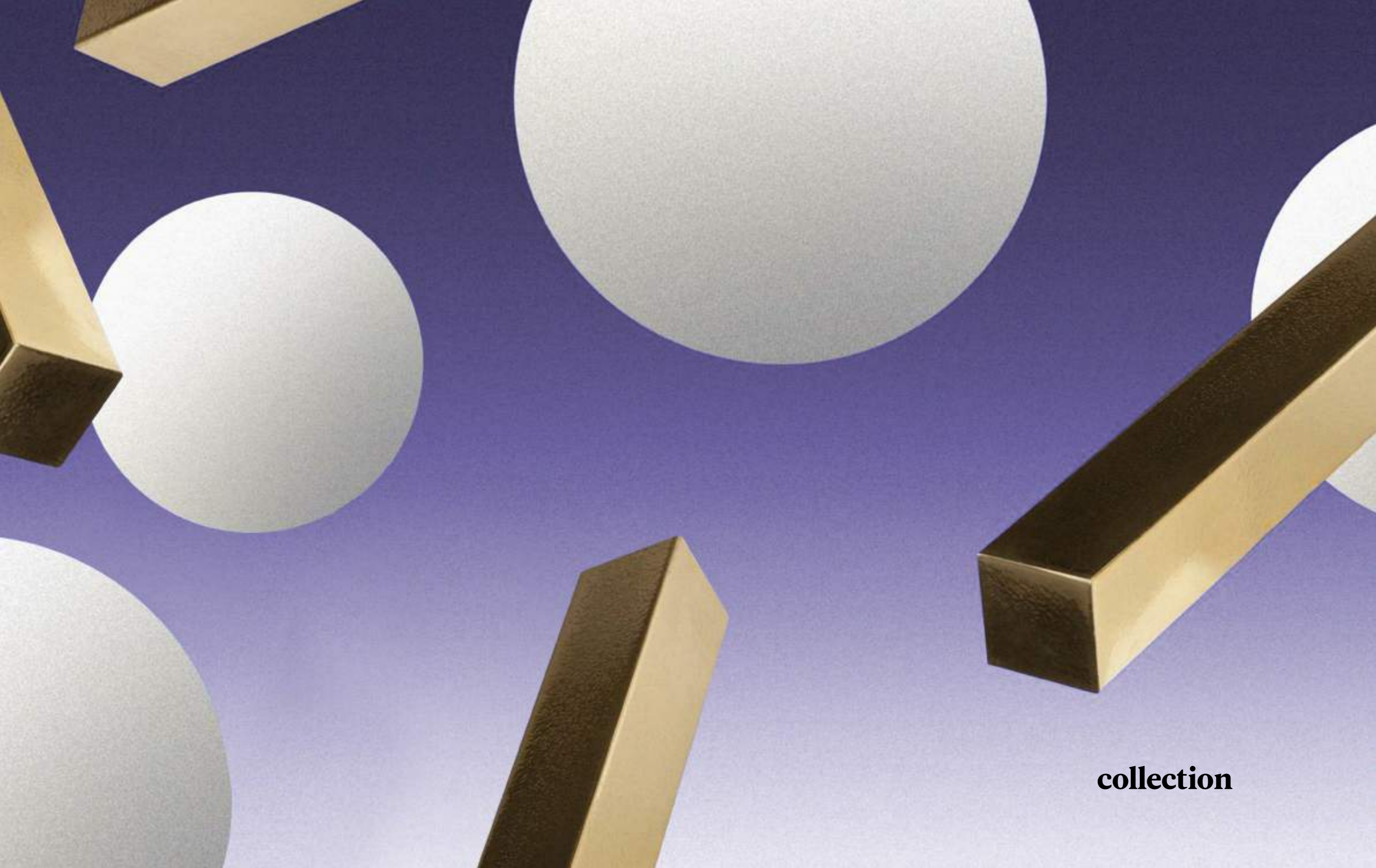

**collection**





suspension lamp



1

## monaco

w: 94 cm / 37"  
d: 73 cm / 29"  
h: 99 cm / 39"

**structure:** lacquered metal / **detail:** lacquered wood  
**globes:** glass  
**light cylinders:** lacquered metal, natural rattan  
**circles:** polished or satin brass or nickel  
**bulbs** 9 x LED G9 max. 7W ☞

**estrutura:** metal lacado / **detalhe:** madeira lacado  
**globos:** vidro  
**cilindros de luz:** metal lacado, palhinha natural  
**círculos:** latão ou níquel polido  
**lâmpadas** 9 x LED G9 máx. 7W ☞



2



3



1

## monaco I

w: 30 cm / 12"  
d: 15 cm / 6"  
h: 57 cm / 22"

structure: lacquered metal  
globes: glass  
light cylinders: lacquered metal, natural rattan  
circles: polished or satin brass or nickel  
bulbs 6 x LED G9 max. 7W

estrutura: metal lacado  
globos: vidro  
cilindros de luz: metal lacado, palhinha natural  
círculos: latão ou níquel polido  
lâmpadas 6 x LED G9 máx.7W

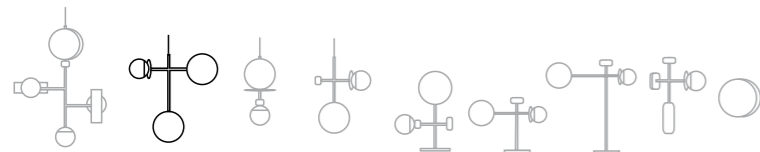

2



3



1

## monaco II

w: 45 cm / 18"  
d: 15 cm / 6"  
h: 65 cm / 26"

structure: lacquered metal / detail: lacquered wood  
globes: glass  
light cylinders: lacquered metal, natural rattan  
circles: polished or satin brass or nickel  
bulbs 3 x LED G9 max. 7W

estrutura: metal lacado / detalhe: madeira lacado  
globos: vidro  
cilindros de luz: metal lacado, palhinha natural  
círculos: latão ou níquel polido  
lâmpadas 3 x LED G9 máx.7W

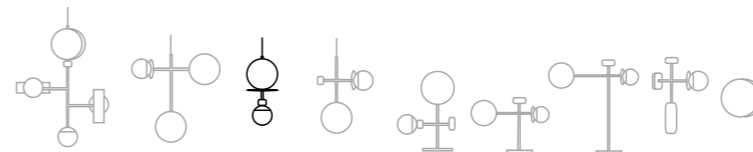

2



3











suspension lamp



1

## monaco III

w: 44 cm / 17"  
 d: 15 cm / 6"  
 h: 70 cm / 28"

structure: lacquered metal / detail: lacquered wood  
 globes: glass  
 light cylinders: lacquered metal, natural rattan  
 circles: polished or satin brass or nickel  
 bulbs 6 x LED G9 max. 7W

estrutura: metal lacado / detalhe: madeira lacado  
 globos: vidro  
 cilindros de luz: metal lacado, palhinha natural  
 círculos: latão ou níquel polido  
 lâmpadas 6 x LED G9 máx. 7W

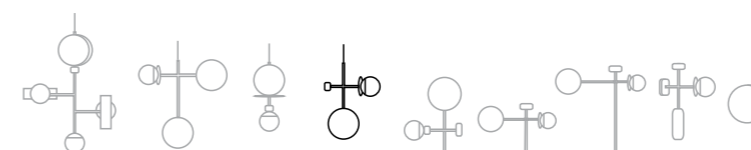

2

3



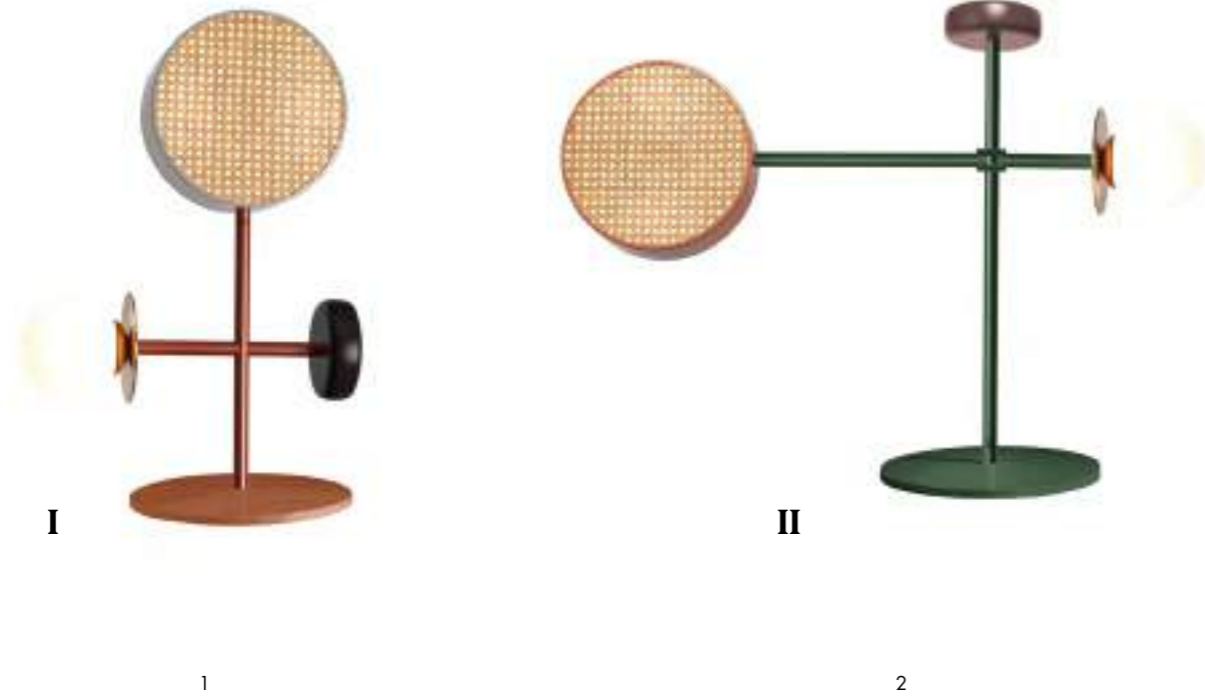

### monaco table I/II (adjustable arm/braço ajustável)

I w: 45 cm / 18"    II w: 65 cm / 26"  
 d: 25 cm / 10"    d: 25 cm / 10"  
 h: 65 cm / 26"    h: 75 cm / 30"

structure: lacquered metal / **detail:** lacquered wood  
 globes: glass  
 light cylinders: lacquered metal, natural rattan  
 circles: polished or satin brass or nickel  
 bulbs 3 x LED G9 max. 7W ☞

estrutura: metal lacado / **detalhe:** madeira lacado  
 globos: vidro  
 cilindros de luz: metal lacado, palhinha natural  
 círculos: latão ou níquel polido  
 lâmpadas 3 x LED G9 máx. 7W ☞

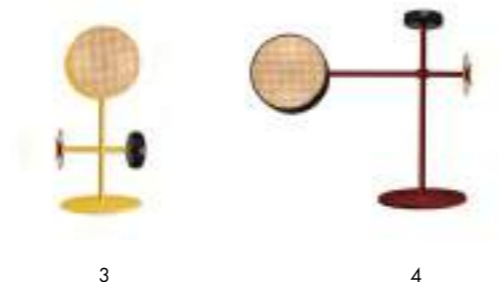
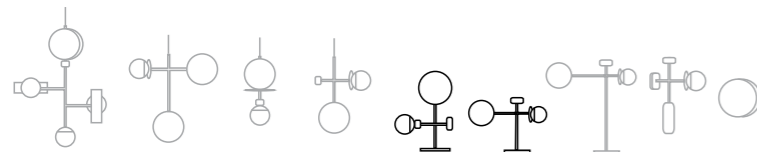

### monaco floor (adjustable arm/braço ajustável)

w: 110 cm / 43"  
 d: 40 cm / 16"  
 h: 169 cm / 67"

structure: lacquered metal / **detail:** lacquered wood  
 globes: glass  
 light cylinders: lacquered metal, natural rattan  
 circles: polished or satin brass or nickel  
 bulbs 3 x LED G9 max. 7W ☞

estrutura: metal lacado / **detalhe:** madeira lacado  
 globos: vidro  
 cilindros de luz: metal lacado, palhinha natural  
 círculos: latão ou níquel polido  
 lâmpadas 3 x LED G9 máx. 7W ☞

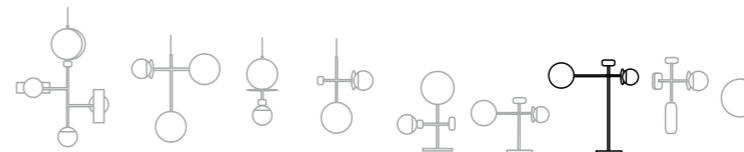

wall lamp



1

wall lamp



1



21

## monaco wall

w: 45 cm / 18"  
d: 27,5 cm / 11"  
h: 70 cm / 28"

structure: lacquered metal / detail: lacquered wood

globes: glass

light cylinders: lacquered metal, natural rattan

circles: polished or satin brass or nickel

bulbs 3 x LED G9 max. 7W ☞

estrutura: metal lacado / detalhe: madeira lacado

globos: vidro

cilindros de luz: metal lacado, palhinha natural

círculos: latão ou níquel polido

lâmpadas 3 x LED G9 máx.7W ☞

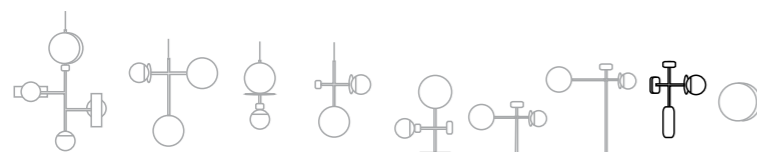

2



3

## monaco wall I

Ø: 27,5 cm / 11"  
45 cm / 18"  
55 cm / 22"  
d: 9 cm / 3,5"

structure: lacquered metal, natural rattan  
bulbs 2 x LED G9 max. 4W ☞

estrutura: metal lacado, palhinha natural  
lâmpadas 2 x LED G9 máx.4W ☞



2



3





PRIVATE RESIDENCE,  
LISBON

suspension lamp



1

## frame

w: 123 cm / 48"  
d: 18 cm / 7"  
h: 75 cm / 30"

structure: lacquered metal, rattan  
globes: glass  
half-circle: terrazzo  
bulbs 5 x LED G9 max. 7W

estrutura: metal lacado, palhinha natural  
globos: vidro  
meio círculo: terrazzo  
lâmpadas 5 x LED G9 máx. 7W

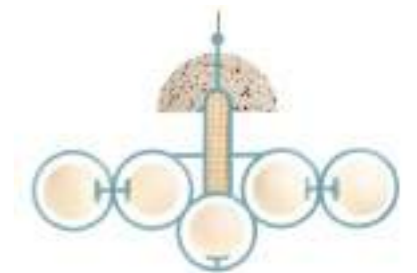
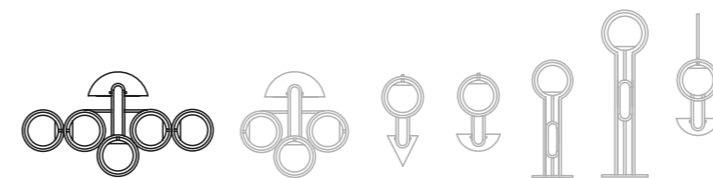

2



1

### frame I

w: 70 cm / 28"  
d: 18 cm / 7"  
h: 64 cm / 25"

structure: lacquered metal, rattan  
globes: glass  
half-circle: terrazzo  
bulbs 3 x LED G9 max. 7W

estrutura: metal lacado, palhinha natural  
globos: vidro  
meio círculo: terrazzo  
lâmpadas 3 x LED G9 máx.7W

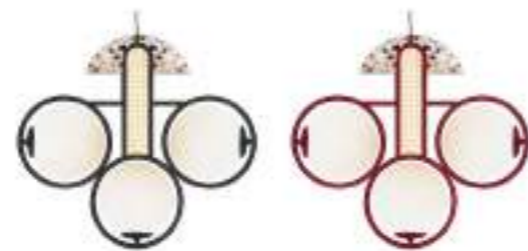
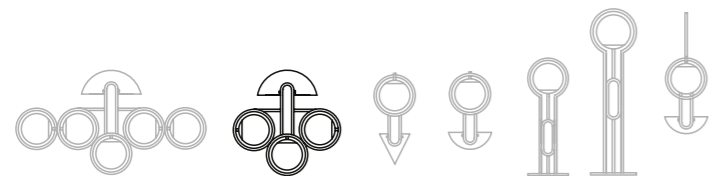

2

3



1

### frame II

w: 28 cm / 11"  
d: 18 cm / 7"  
h triangle: 54 cm / 21" h half-circle: 50 cm / 20"

structure: lacquered metal, rattan  
globe: glass  
triangle/half-circle: terrazzo  
bulbs 1 x LED G9 max. 7W

estrutura: metal lacado, palhinha natural  
globo: vidro  
triângulo/meio círculo: terrazzo  
lâmpadas 1 x LED G9 máx.7W

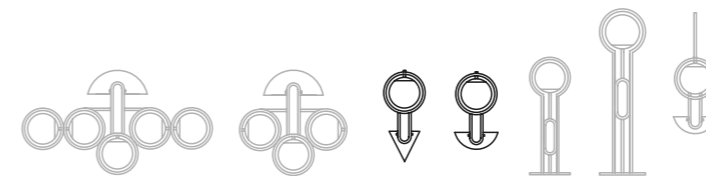

2



3

3





table lamp



1

### frame table

w: 35 cm / 14"  
d: 20 cm / 8"  
h: 65 cm / 26"

structure: lacquered metal, rattan  
globe: glass  
half circle: terrazzo  
bulbs 1 x LED G9 max. 7W

estrutura: metal lacado, palhinha natural  
globo: vidro  
base: terrazzo  
lâmpadas 1 x LED G9 máx.7W

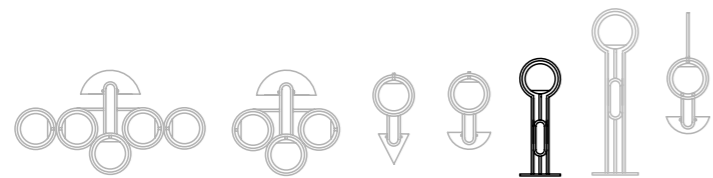

floor lamp



1

### frame floor

w: 40 cm / 16"  
d: 30 cm / 12"  
h: 170 cm / 67"

structure: lacquered metal, rattan  
globe: glass  
base: terrazzo  
bulbs 1 x LED G9 max. 7W

estrutura: metal lacado, palhinha natural  
globo: vidro  
base: terrazzo  
lâmpadas 1 x LED G9 máx.7W

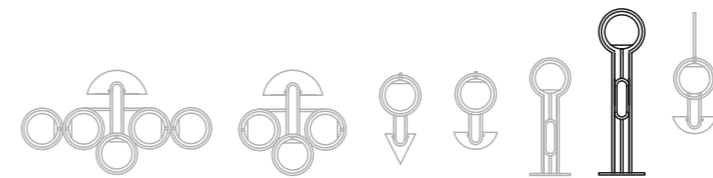

2

3



2

3



wall lamp



1

## frame wall

w: 45 cm / 18"  
d: 28 cm / 11"  
h: 85,5 cm / 34"

structure: lacquered metal, rattan  
globe: glass  
half circle: terrazzo  
bulbs 1 x LED G9 max. 7W 

estrutura: metal lacado, palhinha natural  
globo: vidro  
meio círculo: terrazzo  
lâmpadas 1 x LED G9 máx.7W 

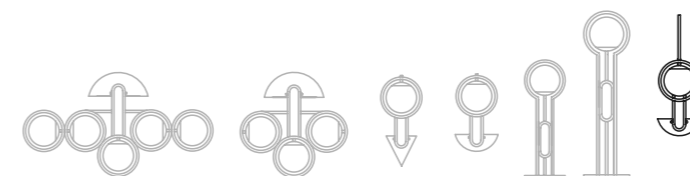

2

3





suspension lamp



1

31

## helio

w: 130 cm / 51"  
 d: 70 cm / 28"  
 h: 80 cm / 31,5"

structure: lacquered metal, polished or satin brass or nickel.  
 globes: glass  
 half spheres: lacquered wood  
 bulbs 7 x LED G9 max. 7W

estrutura: metal lacado, latão ou nickel polido ou satinado  
 globos: vidro  
 meias esferas: madeira lacada  
 lâmpadas 7 x LED G9 máx.7W



2



3



suspension lamp



1

## helio I

w: 120 cm / 47"  
d: 93 cm / 37"  
h: 114 cm / 45"

structure: lacquered metal, polished or satin brass or nickel.

globes: glass

half spheres: lacquered wood

bulbs 9 x LED G9 max. 7W 

estrutura: metal lacado, latão ou nickel polido ou satinado

globos: vidro

meias esferas: madeira lacada

lâmpadas 9 x LED G9 máx.7W 



2



3





1



1

## helio II

w: 35 cm / 14"  
d: 12 cm / 4,7"  
h: 50 cm / 20"

structure: lacquered metal, polished or satin brass or nickel  
globes: glass  
half spheres: lacquered wood  
bulbs 2 x LED G9 max. 7W

estrutura: metal lacado, latão ou nickel polido ou satinado  
globos: vidro  
meias esferas: madeira lacada  
lâmpadas 2 x LED G9 máx.7W

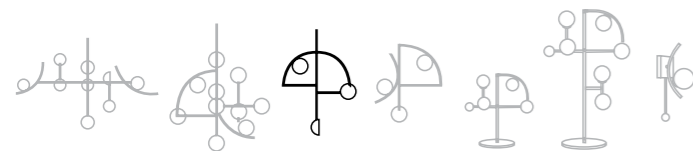

2



3

## helio III

w: 63 cm / 25"  
d: 12 cm / 4,7"  
h: 73 cm / 29"

structure: lacquered metal, polished or satin brass or nickel.  
globes: glass  
half spheres: lacquered wood  
bulbs 2 x LED G9 max. 7W

estrutura: metal lacado, latão ou nickel polido ou satinado  
globos: vidro  
meias esferas: madeira lacada  
lâmpadas 2 x LED G9 máx.7W

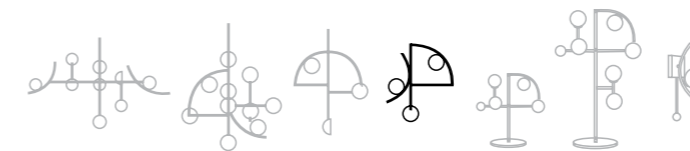

2



3



table lamp



1

## helio table

w: 50 cm / 20"  
d: 25 cm / 10"  
h: 67 cm / 26"

structure: lacquered metal, polished or satin brass or nickel  
globes: glass  
half spheres: lacquered wood  
bulbs 4 x LED G9 max. 7W ☞

estrutura: metal lacado, latão ou nickel polido ou satinado  
globos: vidro  
meias esferas: madeira lacada  
lâmpadas 4 x LED G9 máx.7W ☞



2



3



floor lamp



1

wall lamp



1



## helio floor

w: 95 cm / 37"  
d: 30 cm / 12"  
h: 169 cm / 67"

structure: lacquered metal, polished or satin brass or nickel  
globes: glass  
half spheres: lacquered wood  
bulbs 6 x LED G9 max. 7W

estrutura: metal lacado, latão ou nickel polido ou satinado  
globos: vidro  
meias esferas: madeira lacada  
lâmpadas 6 x LED G9 máx.7W



2



3

## helio wall

w: 15 cm / 6"  
d: 27 cm / 11"  
h: 60 cm / 24"

structure: lacquered metal, polished or satin brass or nickel  
globes: glass  
half spheres: lacquered wood  
bulbs 1 x LED G9 max. 7W

estrutura: metal lacado, latão ou nickel polido ou satinado  
globos: vidro  
meias esferas: madeira lacada  
lâmpadas 1 x LED G9 máx.7W



2



3



1

## globe

Ø: 100 cm / 39"  
h: 50 cm / 20"

structure: lacquered metal, polished or satin brass, copper nickel or bronze  
globes: glass  
bulbs 10 x LED G9 max. 7W 

estrutura: metal lacado, lat o, cobre, nickel ou bronze polido ou satinado  
globos: vidro  
l mpadas 10 x LED G9 m x.7W 



2

3





1



1

# globe I

Ø: 80 cm / 32"  
h: 50 cm / 20"

structure: lacquered metal, polished or satin brass, copper nickel or bronze  
globes: glass  
bulbs 8 x LED G9 max. 7W

estrutura: metal lacado, latão, cobre, nickel ou bronze polido ou satinado  
globos: vidro  
lâmpadas 8 x LED G9 máx.7W

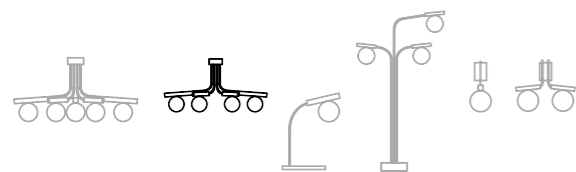

2

3

# globe table

w: 42 cm / 17"  
d: 20 cm / 8"  
h: 59 cm / 23"

structure: lacquered metal, polished or satin brass, copper nickel or bronze  
globes: glass  
optional base: marble  
bulbs 1 x LED G9 max. 7W

estrutura: metal lacado, latão, cobre, nickel ou bronze polido ou satinado  
globos: vidro  
base opcional: mármore  
lâmpadas 1 x LED G9 máx.7W



2

3



TEMAKINHO,  
ROME

floor lamp



1

45

## globe floor

w: 93 cm / 37"  
d: 15 cm / 6"  
h: 169 cm / 67"

structure: lacquered metal, polished or satin brass, copper nickel or bronze  
globes: glass  
optional base: marble  
bulbs 3 x LED G9 max. 7W

estrutura: metal lacado, latão, cobre, nickel ou bronze polido ou satinado  
globos: vidro  
base opcional: mármore  
lâmpadas 3 x LED G9 máx.7W



2

3



wall lamp



1

## globe wall

w: 15 cm / 6"  
d: 27 cm / 11"  
h: 40 cm / 16"

structure: lacquered metal, polished or satin brass, copper nickel or bronze  
globes: glass  
bulbs 1 x LED G9 max. 7W

estrutura: metal lacado, latão, cobre, nickel ou bronze polido ou satinado  
globos: vidro  
lâmpadas 1 x LED G9 máx.7W



wall lamp



1

## globe wall 1

w: 36 cm / 14"  
d: 33 cm / 13"  
h: 41 cm / 16"

structure: lacquered metal, polished or satin brass, copper nickel or bronze  
globes: glass  
bulbs 2 x LED G9 max. 7W

estrutura: metal lacado, latão, cobre, nickel ou bronze polido ou satinado  
globos: vidro  
lâmpadas 2 x LED G9 máx.7W

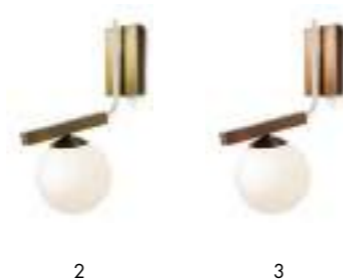

2

3



2

3



suspension lamp



1

## link

w: 100 cm / 39"  
d: 64 cm / 25"  
h: 100 cm / 39"

structure: lacquered metal, polished or satin brass, copper nickel or bronze

globes: glass  
bulbs 4 x LED G9 max. 7W

estrutura: metal lacado, latão, cobre, nickel ou bronze polido ou satinado

globos: vidro  
lâmpadas 4 x LED G9 máx.7W

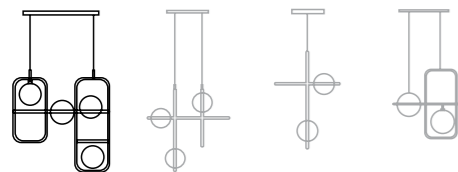

2

suspension lamp



1

## link I

w: 100 cm / 39"  
d: 33 cm / 13"  
h: 100 cm / 39"

structure: lacquered metal, polished or satin brass, copper nickel or bronze

globes: glass  
bulbs 3x LED G9 max. 7W

estrutura: metal lacado, latão, cobre, nickel ou bronze polido ou satinado

globos: vidro  
lâmpadas 3 x LED G9 máx.7W

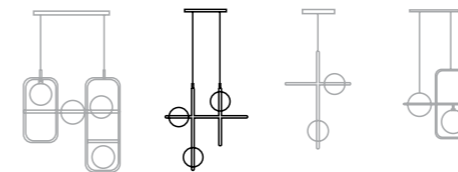

2





suspension lamp



1

## link II

w: 64 cm / 25"  
d: 33 cm / 13"  
h: 100 cm / 39"

**structure:** lacquered metal, polished or satin brass, copper nickel or bronze  
**globes:** glass  
bulbs 2 x LED G9 max. 7W 

**estrutura:** metal lacado, latão, cobre, nickel ou bronze polido ou satinado  
**globos:** vidro  
lâmpadas 2 x LED G9 máx.7W 

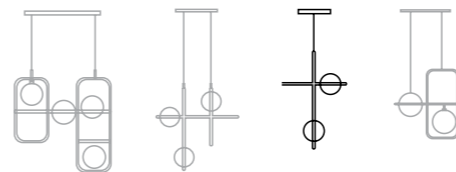

2



suspension lamp



1

### link III

w: 64 cm / 25"  
d: 64 cm / 25"  
h: 64 cm / 25"

**structure:** lacquered metal, polished or satin brass, copper nickel or bronze  
**globes:** glass  
bulbs 2 x LED G9 max. 7W 

**estrutura:** metal lacado, latão, cobre, nickel ou bronze polido ou satinado  
**globos:** vidro  
lâmpadas 2 x LED G9 máx.7W 

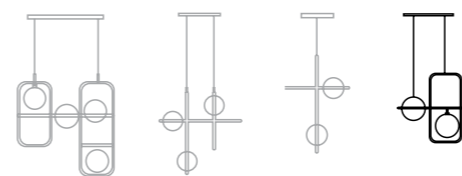

2





1



1

# jules

Ø: 73 cm / 29"  
h: 72 cm / 28"

**structure:** lacquered metal, polished or satin brass, copper nickel or bronze  
**tubes:** polished brass, nickel cooper or bronze.  
**abat-jour:** linen  
energy saving bulb E27 / 1x23W

**estrutura:** metal lacado, latão, cobre, nickel ou bronze polido ou satinado  
**tubos:** latão, nickel, cobre ou bronze polido  
**abat-jour:** linho  
lâmpada económica E27 / 1x23W

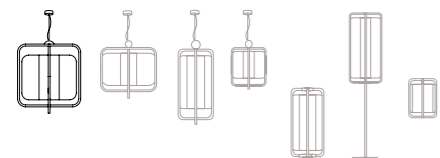

2



3

# jules I

Ø: 63 cm / 25"  
h: 57 cm / 21"

**structure:** lacquered metal, polished or satin brass, copper nickel or bronze  
**tubes:** polished brass, nickel cooper or bronze.  
**abat-jour:** linen  
energy saving bulb E27 / 1x23W

**estrutura:** metal lacado, latão, cobre, nickel ou bronze polido ou satinado  
**tubos:** latão, nickel, cobre ou bronze polido  
**abat-jour:** linho  
lâmpada económica E27 / 1x23W

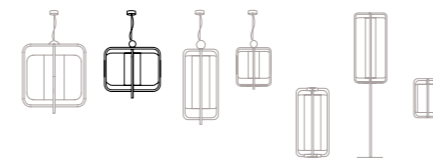

2



3







suspension lamp



1

## jules II

Ø: 30 cm / 12"  
h: 64 cm / 25"

**structure:** lacquered metal, polished or satin brass, copper nickel or bronze

**tubos:** polished brass, nickel cooper or bronze.

**abat-jour:** linen

energy saving bulb E27 / 1x23W 

**estrutura:** metal lacado, latão, cobre, nickel ou bronze polido ou satinado

**tubos:** latão, nickel, cobre ou bronze polido

**abat-jour:** linho

lâmpada económica E27 / 1x23W 

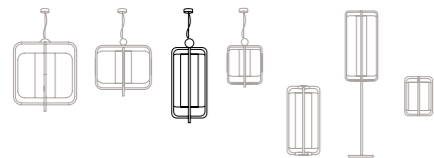

2



3

suspension lamp



1

## jules III

Ø: 38 cm / 15"  
h: 44 cm / 17"

**structure:** lacquered metal, polished or satin brass, copper nickel or bronze

**tubos:** polished brass, nickel cooper or bronze.

**abat-jour:** linen

energy saving bulb E27 / 1x23W 

**estrutura:** metal lacado, latão, cobre, nickel ou bronze polido ou satinado

**tubos:** latão, nickel, cobre ou bronze polido

**abat-jour:** linho

lâmpada económica E27 / 1x23W 

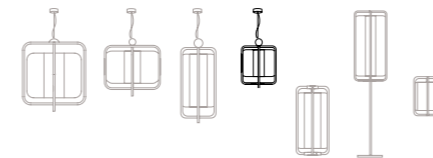

2



3







table lamp



1

## jules table

Ø: 30 cm / 12"  
h: 63 cm / 25"

structure: lacquered metal, polished or satin brass, copper nickel or bronze  
tubes: polished brass, nickel copper or bronze.  
abat-jour: linen  
energy saving bulb E27 / 1x23W ◀

estrutura: metal lacado, latão, cobre, nickel ou bronze polido ou satinado  
tubos: latão, nickel, cobre ou bronze polido  
abat-jour: linho  
lâmpada económica E27 / 1x23W ◀

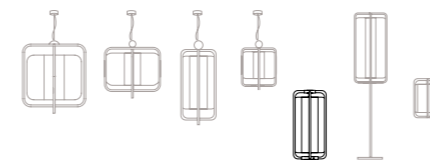

2



3

floor lamp



1

## jules floor

Ø: 38 cm / 15"  
h: 177 cm / 38"

**structure:** lacquered metal, polished or satin brass, copper nickel or bronze  
**tubes:** polished brass, nickel cooper or bronze.

**abat-jour:** linen  
energy saving bulb E27 / 1x23W

**estrutura:** metal lacado, latão, cobre, nickel ou bronze polido ou satinado  
**tubos:** latão, nickel, cobre ou bronze polido  
**abat-jour:** linho  
lâmpada económica E27 / 1x23W

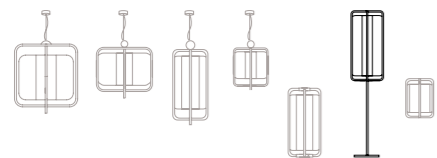

2



3

wall lamp



1

## jules wall

w: 40 cm / 16"  
d: 23 cm / 9"  
h: 40 cm / 16"

**structure:** lacquered metal, polished or satin brass, copper nickel or bronze  
**tubes:** polished brass, nickel cooper or bronze.

**abat-jour:** linen  
energy saving bulb E14 / 1x20W

**estrutura:** metal lacado, latão, cobre, nickel ou bronze polido ou satinado  
**tubos:** latão, nickel, cobre ou bronze polido  
**abat-jour:** linho  
lâmpada económica E14 / 1x20W

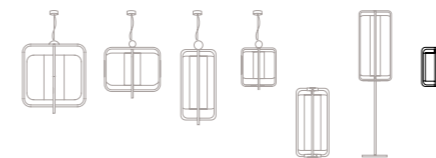

2



3







PRIVATE RESIDENCE,  
RUSSIA

suspension lamp



1

65

## comb

Ø: 74 cm / 29"  
h: 60 cm / 24"

structure: lacquered metal  
rings: lacquered metal, polished brass or copper  
energy saving bulb E27 / 1x23W ◐

estrutura: metal lacado  
anéis: metal lacado, latão ou cobre polido  
lâmpada económica E27 / 1x23W ◐

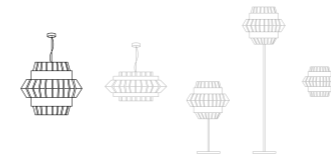

2



3





suspension lamp





6

1

## comb I

Ø: 75 cm / 30"  
h: 35 cm / 14"

structure: lacquered metal  
rings: lacquered metal, polished brass or copper  
energy saving bulb E27 / 1x23W 

estrutura: metal lacado  
anéis: metal lacado, latão ou cobre polido  
lâmpada económica E27 / 1x23W 

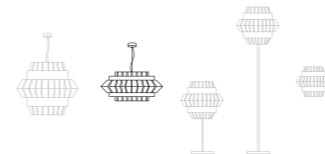

2



3





TEMAKINHO,  
MOROCCO

table lamp





1

69

## comb table

Ø: 25,5 cm / 10"  
h: 60 cm / 24"

structure: lacquered metal  
rings: lacquered metal, polished brass or copper  
energy saving bulb E14 / 1x20W 

estrutura: metal lacado  
anéis: metal lacado, latão ou cobre polido  
lâmpada económica E14 / 1x20W 

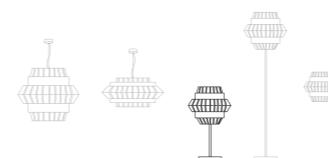

2



3



ZANNOTTA SHOWROOM,  
ITALY



floor lamp



1

## comb floor

Ø: 54 cm / 21"  
h: 175 cm / 69"

structure: lacquered metal  
rings: lacquered metal, polished brass or copper  
energy saving bulb E27 / 1x23W 

estrutura: metal lacado  
anéis: metal lacado, latão ou cobre polido  
lâmpada económica E27 / 1x23W 

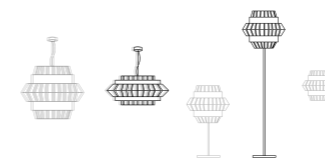

2



3





wall lamp



1

## comb wall

w: 37 cm / 15"  
d: 13 cm / 5"  
h: 34 cm / 13"

structure: lacquered metal  
rings: lacquered metal, polished brass or copper  
energy saving bulb E14 / 1x15W 

estrutura: metal lacado  
anéis: metal lacado, latão ou cobre polido  
lâmpada económica E14 / 1x15W 

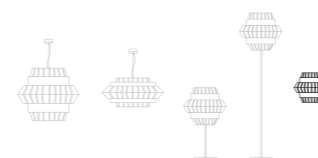

2



3





suspension lamp



1

## loop

w: 55 cm / 22"  
d: 25 cm / 10"  
h: 77 cm / 30"

structure: lacquered metal, polished or satin brass, copper, bronze or nickel  
globe: glass  
bulbs 1 x LED G9 max. 7W 

estrutura: metal lacado, latão, cobre, bronze ou nickel polido ou satinado  
globo: vidro  
lâmpadas 1 x LED G9 máx. 7W 



2

3





suspension lamp



1

## loop I

w: 26 cm / 10"  
d: 15 cm / 6"  
h: 74 cm / 29"

**structure:** lacquered metal, polished or satin brass, copper, bronze or nickel  
**globe:** glass  
**bulbs** 1 x LED G9 max. 7W 

**estrutura:** metal lacado, latão, cobre, bronze ou nickel polido ou satinado  
**globo:** vidro  
**lâmpadas** 1 x LED G9 máx. 7W 



2



3



suspension lamp

table lamp



1



1

## loop II

w: 31 cm / 12"  
d: 15 cm / 6"  
h: 47 cm / 18"

structure: lacquered metal, polished or satin brass, copper, bronze or nickel  
globe: glass  
bulbs 1 x LED G9 max. 7W

estrutura: metal lacado, latão, cobre, bronze ou nickel polido ou satinado  
globo: vidro  
lâmpadas 1 x LED G9 máx.7W

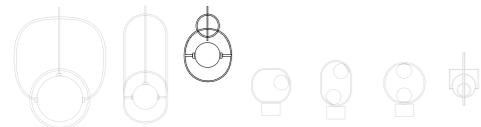

2

3

## loop table

w: 36 cm / 14"  
d: 15 cm / 6"  
h: 38 cm / 15"

structure: lacquered metal, polished or satin brass, copper, bronze or nickel  
globe: glass  
optional base: marble  
bulbs 7 x LED G9 max. 7W

estrutura: metal lacado, latão, cobre, bronze ou nickel polido ou satinado  
globo: vidro  
base opcional: mármore  
lâmpadas 7 x LED G9 máx.7W

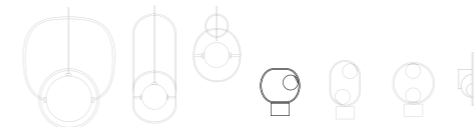

2



3

table lamp



table lamp



81

## loop table I

w: 30 cm / 12"  
d: 15 cm / 6"  
h: 50 cm / 20"

structure: lacquered metal, polished or satin brass, copper, bronze or nickel  
globe: glass  
optional base: marble  
bulbs 2 x LED G9 max. 7W

estrutura: metal lacado, latão, cobre, bronze ou nickel polido ou satinado  
globo: vidro  
base opcional: mármore  
lâmpadas 2 x LED G9 máx.7W



2

3

## loop table II

w: 43 cm / 17"  
d: 15 cm / 6"  
h: 47 cm / 19"

structure: lacquered metal, polished or satin brass, copper, bronze or nickel  
globe: glass  
optional base: marble  
bulbs 2 x LED G9 max. 7W

estrutura: metal lacado, latão, cobre, bronze ou nickel polido ou satinado  
globo: vidro  
base opcional: mármore  
lâmpadas 2 x LED G9 máx.7W



2

3





wall lamp





1



## loop wall

w: 15 cm / 6"  
d: 30 cm / 12"  
h: 27 cm / 11"

structure: lacquered metal, polished or satin brass, copper, bronze or nickel  
globe: glass  
bulbs 1 x LED G9 max. 7W 

estrutura: metal lacado, latão, cobre, bronze ou nickel polido ou satinado  
globo: vidro  
lâmpadas 1 x LED G9 máx.7W 



2



3





RESTORAN NA MOSFILMOVSKAYA  
MOSCOW

suspension lamp



1

## magnolia

Ø: 65 cm / 26"  
h: 68 cm / 27"

top: lacquered metal  
structure: lacquered metal, polished or satin brass, copper, bronze or nickel  
ring: lacquered metal, polished or brushed metal  
energy saving bulb E27 / 1x23W ◯

topo: metal lacado  
estrutura: metal lacado, latão, cobre, bronze ou nickel polido ou satinado  
anel: metal lacado, metal polido ou escovado  
lâmpada económica E27 / 1x23W ◯

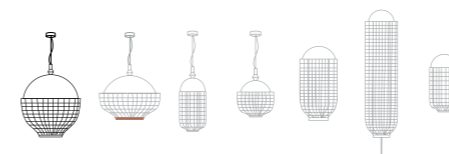

2

3



suspension lamp



1

## magnolia I

Ø: 65 cm / 26"  
h: 47 cm / 19"

top: lacquered metal  
structure: lacquered metal, polished or satin brass, copper or nickel  
ring: lacquered metal, polished or satin brass, copper, bronze or nickel  
energy saving bulb E27 / 1x23W

topo: metal lacado  
estrutura: metal lacado, latão, cobre ou nickel polido ou satinado  
anel: metal lacado, latão, cobre, bronze ou nickel polido ou satinado  
lâmpada económica E27 / 1x23W

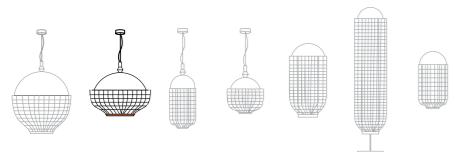

2

3

suspension lamp



1

## magnolia II

Ø: 27 cm / 11"  
h: 59 cm / 23"

top: lacquered metal, polished or brushed metal  
structure: lacquered metal, polished or satin brass, copper or nickel  
ring: lacquered metal, polished or satin brass, copper, bronze or nickel  
abat-jour: cotton  
energy saving bulb E27 / 1x23W

topo: metal lacado  
estrutura: metal lacado, latão, cobre ou nickel polido ou satinado  
anel: metal lacado, latão, cobre, bronze ou nickel polido ou satinado  
abat-jour: algodão  
lâmpada económica E27 / 1x23W



2

3



suspension lamp



1

## magnolia III

Ø: 31 cm / 12"  
h: 42 cm / 17"

top: lacquered metal, polished or satin brass, copper, bronze or nickel  
 structure: lacquered metal, polished or satin brass, copper or nickel  
 ring: lacquered metal, polished or satin brass, copper, bronze or nickel  
 abat-jour: cotton  
 energy saving bulb E27 / 1x23W 

topo: metal lacado, latão, cobre, bronze ou nickel polido ou satinado  
 estrutura: metal lacado, latão, cobre ou nickel polido ou satinado  
 anel: metal lacado, latão, cobre, bronze ou nickel polido ou satinado  
 abat-jour: algodão  
 lâmpada económica E27 / 1x23W 



2



3



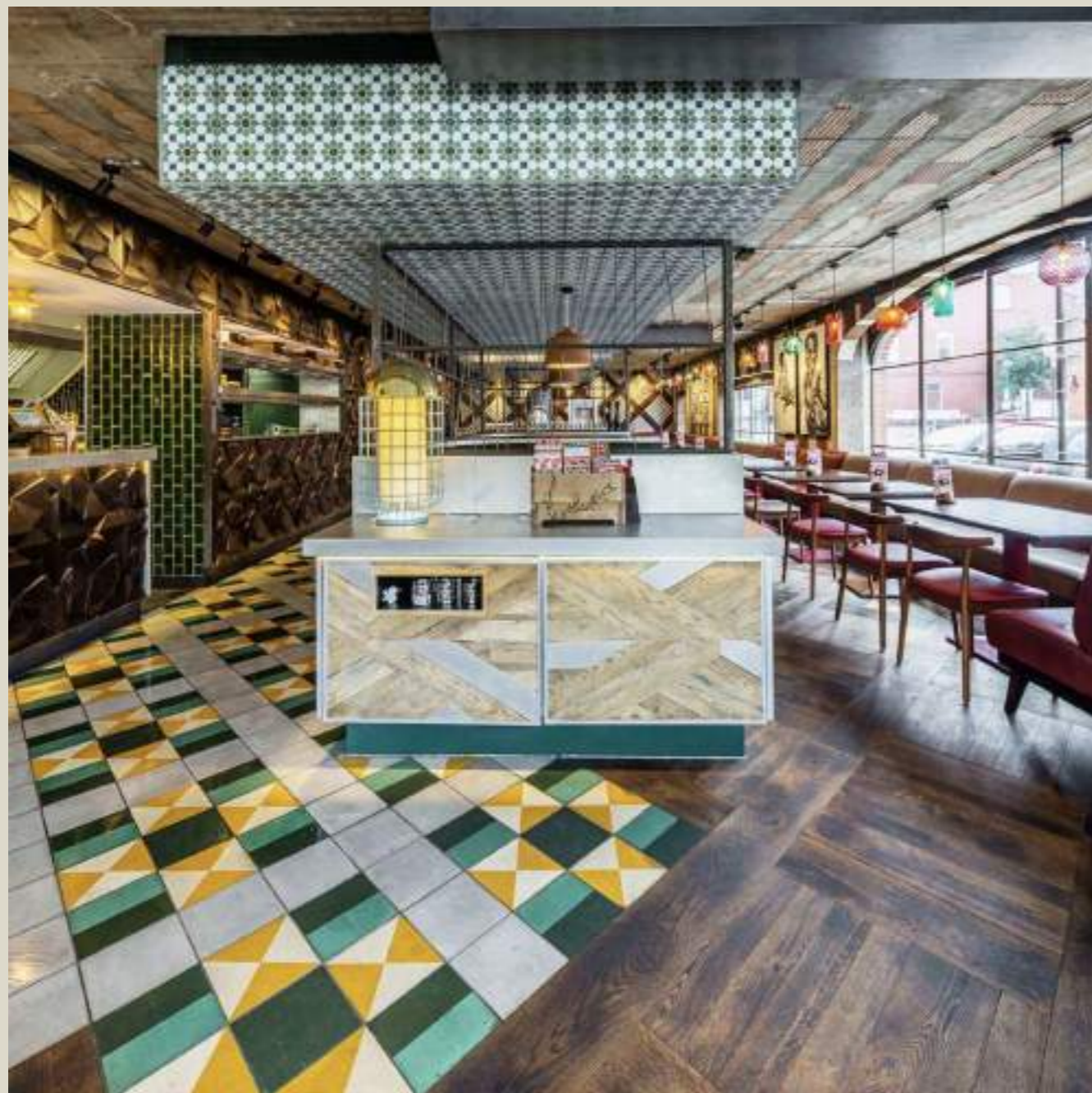

NANDO'S RESTAURANT,  
SOUTHAMPTON

table lamp



1

## magnolia table

Ø: 32 cm / 13"  
h: 63 cm / 25"

**top:** lacquered metal, polished or satin brass, copper, bronze or nickel  
**structure:** lacquered metal, polished or satin brass, copper or nickel  
**abat-jour:** cotton  
energy saving bulb E27 / 1x23W 

**topo:** metal lacado, latão, cobre, bronze ou nickel polido ou satinado  
**estrutura:** metal lacado, latão, cobre ou nickel polido ou satinado  
**abat-jour:** algodão  
lâmpada económica E27 / 1x23W 

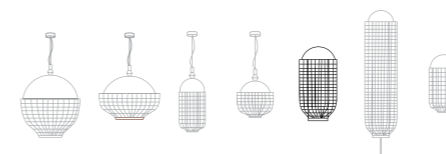

2



3

floor lamp



1

## magnolia floor

Ø: 37 cm / 15"  
h: 170 cm / 67"

**top:** lacquered metal, polished or satin brass, copper, bronze or nickel  
**structure:** lacquered metal, polished or satin brass, copper or nickel  
**abat-jour:** cotton  
energy saving bulb E27 / 1x23W

**topo:** metal lacado, latão, cobre, bronze ou nickel polido ou satinado  
**estrutura:** metal lacado, latão, cobre ou nickel polido ou satinado  
**abat-jour:** algodão  
lâmpada económica E27 / 1x23W

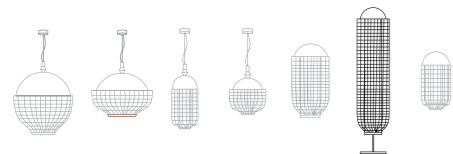

wall lamp



1

## magnolia wall

w: 30 cm / 12"  
d: 13 cm / 5"  
h: 56 cm / 22"

**top:** lacquered metal, polished or satin brass, copper, bronze or nickel  
**structure:** lacquered metal, polished or satin brass, copper or nickel  
**abat-jour:** cotton  
energy saving bulb E27 / 1x23W

**topo:** metal lacado, latão, cobre, bronze ou nickel polido ou satinado  
**estrutura:** metal lacado, latão, cobre ou nickel polido ou satinado  
**abat-jour:** algodão  
lâmpada económica E27 / 1x23W

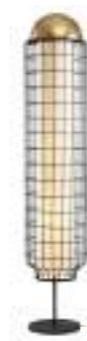
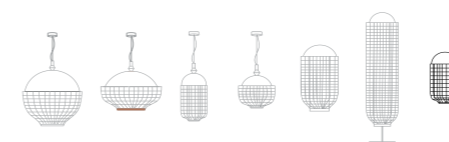

2



3



2



3







1

## carousel

5 arms 5 braços    3 arms 3 braços  
Ø: 110 cm / 43"    Ø: 89 cm / 35"  
h: 40 cm / 16"    h: 40 cm / 16"

estrutura: lacquered metal  
abat-jours: cotton  
energy saving bulb E27 / 3 or 5 x23W 

estrutura: metal lacado  
abat-jours: algodão  
lâmpada económica E27 / 3 or 5 x23W 

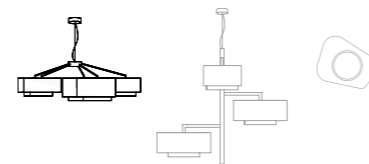

2



3

suspension lamp



1

wall lamp



1



97

## carousel I

Ø: 97 cm / 38"  
h: 86 cm / 34"

estrutura: lacquered metal  
abat-jours: cotton  
energy saving bulb E27 / 3x23W

estrutura: metal lacado  
abat-jours: algodão  
lâmpada económica E27 / 3x23W

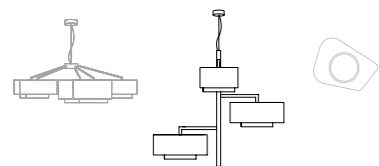

2



3

## carousel wall

w: 40 cm / 16"  
d: 18 cm / 7"  
h: 30 cm / 12"

cup: lacquered metal  
abat-jour: cotton  
energy saving bulb E27 / 1x20W

estrutura: metal lacado  
abat-jours: algodão  
lâmpada económica E27 / 1x20W

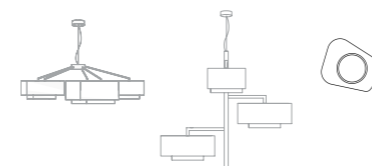

2



3





suspension lamp



1

## expand

Ø: 50 cm / 20"  
h: 70 cm / 28"

structure: lacquered metal  
energy saving bulb E27 / 1x23W

estrutura: metal lacado  
lâmpada económica E27 / 1x23W



2



3



suspension lamp



1

## revolution

Ø: 55 cm / 22"  
h: 70 cm / 28"

structure: lacquered metal  
energy saving bulb E27 / 1x23W

estrutura: metal lacado  
lâmpada económica E27 / 1x23W



2



3









suspension lamp



1

## circus

Ø: 56 cm / 22"  
h: 73 cm / 29"

structure: lacquered metal, polished or oxidized brass  
abat-jour: cotton  
energy saving bulb E27 / 5x23W

estrutura: metal lacado, latão polido ou escovado  
abat-jour: algodão  
lâmpada económica E27 / 5x23W

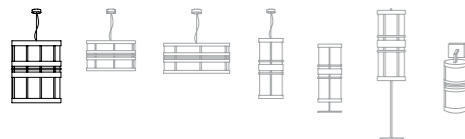

2

3

suspension lamp



1

## circus I

Ø: 56 cm / 22"  
h: 38 cm / 15"

structure: lacquered metal, polished or oxidized brass  
abat-jour: cotton  
energy saving bulb E27 / 5x23W

estrutura: metal lacado, latão polido ou escovado  
abat-jour: algodão  
lâmpada económica E27 / 5x23W

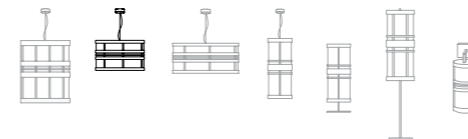

2

3







LE BERRY RESTAURANT,  
FRANCE

suspension lamp



1

## circus II

Ø: 65 cm / 26"  
h: 34 cm / 13"

structure: lacquered metal, polished or oxidized brass  
abat-jour: cotton  
energy saving bulb E27 / 5x23W

estrutura: metal lacado, latão polido ou escovado  
abat-jour: algodão  
lâmpada económica E27 / 5x23W

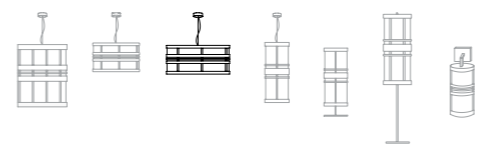

2



3





PRIVATE RESIDENCE,  
RUSSIA

suspension lamp





19

1

## circus III

Ø: 38 cm / 15"  
h: 66 cm / 26"

structure: lacquered metal, polished or oxidized brass  
abat-jour: cotton  
energy saving bulb E27 / 5x20W 

estrutura: metal lacado, latão polido ou escovado  
abat-jour: algodão  
lâmpada económica E27 / 5x20W 

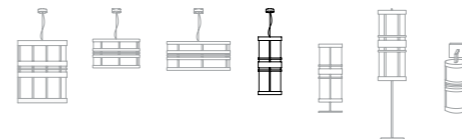

2



3



table lamp



1

floor lamp



1

## circus table

Ø: 30 cm / 12"  
h: 76 cm / 30"

structure: lacquered metal, polished or oxidized brass  
abat-jour: cotton  
energy saving bulb E27 / 1x15W

estrutura: metal lacado, latão polido ou escovado  
abat-jour: algodão  
lâmpada económica E27 / 1x15W

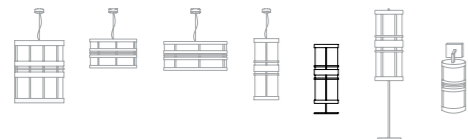

2



3

## circus floor

Ø: 35 cm / 14"  
h: 170 cm / 67"

structure: lacquered metal, polished or oxidized brass  
abat-jour: cotton  
energy saving bulb E27 / 6x15W

estrutura: metal lacado, latão polido ou escovado  
abat-jour: algodão  
lâmpada económica E27 / 6x15W

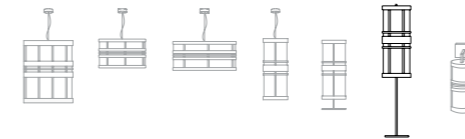

2



3





wall lamp





1

113

## circus wall

w: 27 cm / 11"  
d: 30 cm / 11"  
h: 62 cm / 24"

structure: lacquered metal, polished or oxidized brass  
abat-jour: cotton  
energy saving bulb E14 / 1x20W 

estrutura: metal lacado, latão polido ou escovado  
abat-jour: algodão  
lâmpada económica E14 / 1x20W 

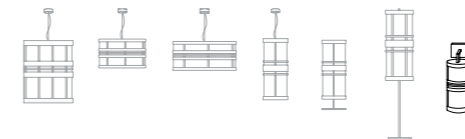

2



3





FIREEYE OFFICES,  
THE NETHERLANDS

suspension lamp



1

## up

Ø: 55 cm / 22"  
h: 72 cm / 28"

structure: lacquered metal  
ring: lacquered metal  
abat-jour: cotton  
energy saving bulb E27 / 1x23W 

estrutura: metal lacado  
anel: metal lacado  
abat-jour: algodão  
lâmpada económica E27 / 1x23W 

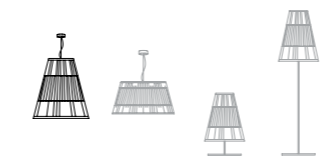

2



3

suspension lamp

table lamp



1



1r

# up I

Ø: 68 cm / 27"  
h: 39 cm / 15"

structure: lacquered metal  
ring: lacquered metal  
abat-jour: cotton  
energy saving bulb E27 / 1x23W

estrutura: metal lacado  
anel: metal lacado  
abat-jour: algodão  
lâmpada económica E27 / 1x23W

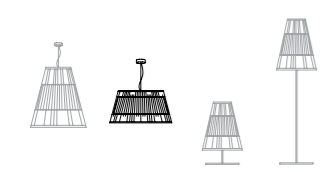

2



3

# up table

Ø: 44 cm / 17"  
h: 72 cm / 28"

structure: lacquered metal  
ring: lacquered metal  
abat-jour: cotton  
energy saving bulb E27 / 1x15W

estrutura: metal lacado  
anel: metal lacado  
abat-jour: algodão  
lâmpada económica E27 / 1x15W

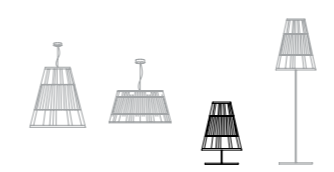

2



3







HOTEL DAS SONNREICH,  
GERMANY

floor lamp



1

## up floor

Ø: 47 cm / 19"  
h: 170 cm / 67"

structure: lacquered metal  
ring: lacquered metal  
abat-jour: cotton  
energy saving bulb E27 / 1x23W 

estrutura: metal lacado  
anel: metal lacado  
abat-jour: algodão  
lâmpada económica E27 / 1x23W 



119



2



3

suspension lamp



1

## extrude

Ø: 60 cm / 24"  
h: 70 cm / 28"

structure: lacquered metal  
abat-jour: cotton  
energy saving bulb E27 / 1x23W

estrutura: metal lacado  
abat-jours: algodão  
lâmpada económica E27 / 1x23W

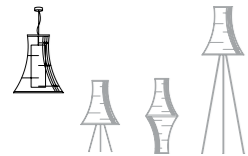

2

3

table lamp



1

## extrude table

Ø: 34 cm / 13"  
h: 70 cm / 28"

structure: lacquered metal  
energy saving bulb E27 / 1x15W

estrutura: metal lacado  
lâmpada económica E27 / 1x15W

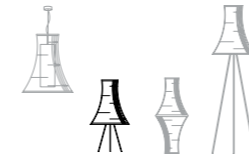

2



3





table lamp



1

## extrude table I

Ø: 14 cm / 5"  
h: 75 cm / 30"

structure: lacquered metal  
energy saving bulb E27 / 1x15W

estrutura: metal lacado  
lâmpada económica E27 / 1x15W

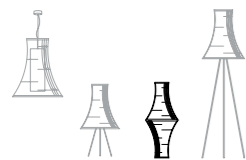

2



3

floor lamp



1

## extrude floor

Ø: 50 cm / 20"  
h: 175 cm / 69"

structure: lacquered metal  
energy saving bulb E27 / 1x23W

estrutura: metal lacado  
lâmpada económica E27 / 1x23W

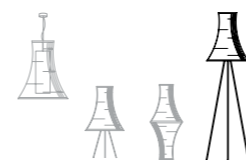

2



3







DRAKE & MORGAN AT KING'S CROSS,  
UNITED KINGDOM

suspension lamp





125

1

## star

Ø: 80 cm / 32"  
h: 70 cm / 28"

structure: lacquered metal, polished or satin brass, copper or nickel  
abat-jour: linen  
energy saving bulb E27 / 1x23W 

estrutura: metal lacado, latão, cobre ou nickel  
abat-jour: linho  
lâmpada económica E27 / 1x23W 

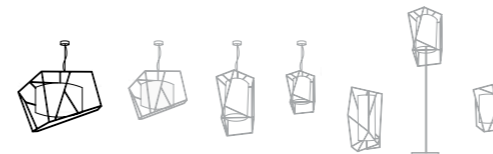

2



3



suspension lamp



1

## star I

Ø: 60 cm / 24"  
h: 50 cm / 20"

structure: lacquered metal, polished or satin brass, copper or nickel  
abat-jour: linen  
energy saving bulb E27 / 1x23W 

estrutura: metal lacado, latão, cobre ou nickel  
abat-jour: linho  
lâmpada económica E27 / 1x23W 

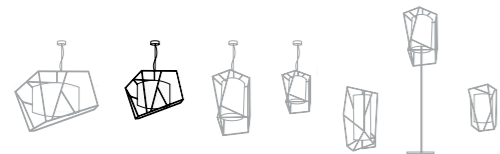

2

3

suspension lamp



1

## star II

Ø: 45 cm / 18"  
h: 72 cm / 28"

structure: lacquered metal, polished or satin brass, copper or nickel  
abat-jour: linen  
energy saving bulb E27 / 1x23W 

estrutura: metal lacado, latão, cobre ou nickel  
abat-jour: linho  
lâmpada económica E27 / 1x23W 

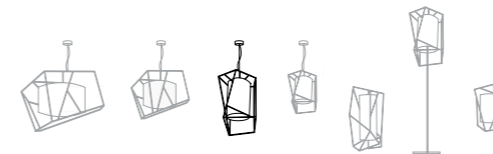

2

3



suspension lamp



1

## star III

Ø: 35 cm / 14"  
h: 53 cm / 21"

structure: lacquered metal, polished or satin brass, copper or nickel  
abat-jour: linen  
energy saving bulb E27 / 1x23W 

estrutura: metal lacado, latão, cobre ou nickel  
abat-jour: linho  
lâmpada económica E27 / 1x23W 

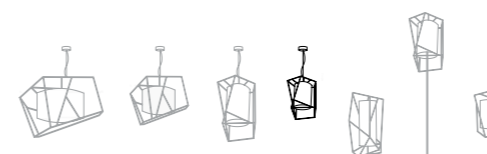

2



3



table lamp



1

floor lamp



1

## star table

Ø: 33 cm / 13"  
h: 72 cm / 28"

structure: lacquered metal, polished or satin brass, copper or nickel  
abat-jour: linen  
energy saving bulb E27 / 1x15W

estrutura: metal lacado, latão, cobre ou nickel  
abat-jour: linho  
lâmpada económica E27 / 1x15W

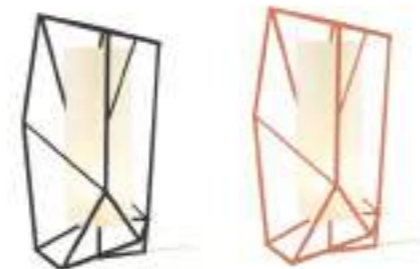
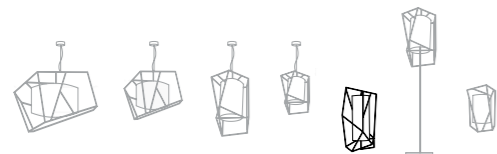

2

3

## star floor

Ø: 45 cm / 18"  
h: 170 cm / 67"

structure: lacquered metal, polished or satin brass, copper or nickel  
abat-jour: linen  
energy saving bulb E27 / 1x23W

estrutura: metal lacado, latão, cobre ou nickel  
abat-jour: linho  
lâmpada económica E27 / 1x23W

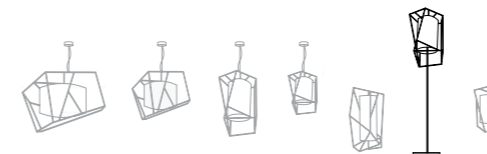

2



3





EL ESTUDIO,  
SANTO DOMINGO

wall lamp



1

## star wall

w: 28 cm / 11"  
d: 20 cm / 67"  
h: 170 cm / 67"

structure: lacquered metal, polished or satin brass, copper or nickel  
abat-jour: linen  
energy saving bulb E27 / 1x20W 

estrutura: metal lacado, latão, cobre ou nickel  
abat-jour: linho  
lâmpada económica E27 / 1x20W 

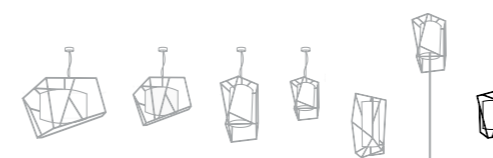

2



3



suspension lamp



1

## spider

Ø: 70 cm / 28"  
h: 35 cm / 14"

structure: lacquered metal  
ring: lacquered metal, polished or satin brass, copper or nickel  
energy saving bulb E27 / 1x23W 

estrutura: metal lacado  
anel: metal lacado, latão, cobre ou nickel  
lâmpada económica E27 / 1x23W 



2



3

suspension lamp



1

## spider I

Ø: 52 cm / 20"  
h: 70 cm / 28"

structure: lacquered metal  
ring: lacquered metal, polished or satin brass, copper or nickel  
energy saving bulb E27 / 1x23W 

estrutura: metal lacado  
anel: metal lacado, latão, cobre ou nickel  
lâmpada económica E27 / 1x23W 



2



3





MR. SAMMI BISTRO  
THE NETHERLANDS

suspension lamp

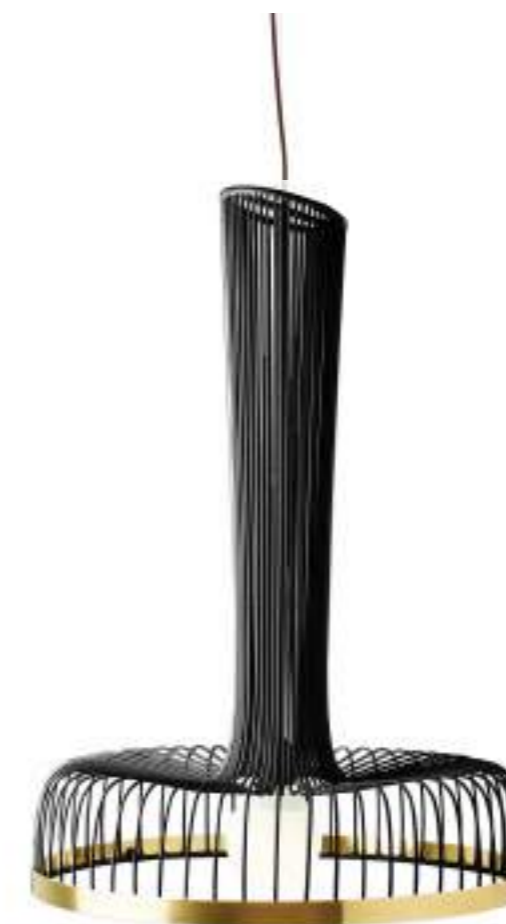

1

## spider II

Ø: 70 cm / 28"  
h: 100 cm / 39"

structure: lacquered metal  
ring: lacquered metal, polished or satin brass, copper or nickel  
energy saving bulb E27 / 1x23W 

estrutura: metal lacado  
anel: metal lacado, latão, cobre ou nickel  
lâmpada económica E27 / 1x23W 



2



3



table lamp



1

floor lamp



1

## spider table

Ø: 24 cm / 9"  
h: 60 cm / 20"

structure: lacquered metal  
ring: lacquered metal, polished or satin brass, copper or nickel  
abat-jour: cotton  
energy saving bulb E27 / 1x15W

estrutura: metal lacado  
anel: metal lacado, latão, cobre ou nickel  
abat-jour: algodão  
lâmpada económica E27 / 1x15W



2

3

## spider floor

Ø: 30 cm / 12"  
h: 140 cm / 55"

structure: lacquered metal  
abat-jour: cotton  
energy saving bulb E27 / 2x23W

estrutura: metal lacado  
abat-jour: algodão  
lâmpada económica E27 / 2x23W



2

3





wall lamp



1

## spider wall

Ø: 25 cm / 10"  
d: 15 cm / 6"  
h: 25 cm / 10"

structure: lacquered metal  
ring: lacquered metal, polished or satin brass, copper or nickel  
abat-jour: cotton  
energy saving bulb E14 / 1x15W 

estrutura: metal lacado  
anel: metal lacado, latão, cobre ou nickel  
abat-jour: algodão  
lâmpada económica E14 / 1x15W 



2



3



**technical  
information**



# suspension lamps

**monaco**

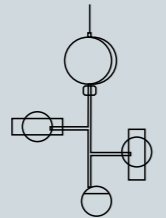

37" / 9 cm  
230V / 50Hz 51 lb | 23 kg  
9 x max. G9 / 7W 0,55 m<sup>3</sup>  
120V / 60Hz  
9 x max. G9 / 7W  
Cable 59" / 1,5m

**monaco I**

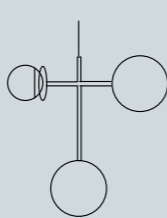

40" / 102 cm  
230V / 50Hz 40 lb | 12 kg  
5 x max. G9 / 7W 0,55 m<sup>3</sup>  
120V / 60Hz  
5 x max. G9 / 7W  
Cable 59" / 1,5m

**helio III**

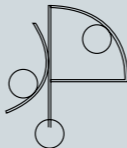

25" / 65 cm  
230V / 50Hz 7 lb | 3 kg  
2 x max. G9 / 7W 0,13 m<sup>3</sup>  
120V / 60Hz  
2 x max. G9 / 7W  
Cable 59" / 1,5m

**globe**

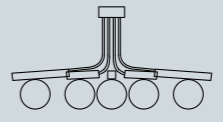

20" / 50 cm  
39" / 100 cm  
230V / 50Hz 17,6 lb | 8 kg  
10 x max. G9 / 7W 0,42 m<sup>3</sup>  
120V / 60Hz  
10 x max. G9 / 7W  
Cable 59" / 1,5m

**globe I**

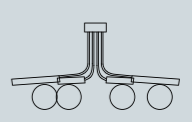

20" / 50 cm  
32" / 80 cm  
230V / 50Hz 8,8 lb | 4 kg  
8 x max. G9 / 7W 0,20 m<sup>3</sup>  
120V / 60Hz  
8 x max. G9 / 7W  
Cable 59" / 1,5m

**monaco II**

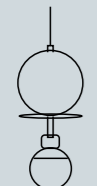

18" / 45 cm  
26" / 65 cm  
230V / 50Hz 27 lb | 12 kg  
3 x max. G9 / 7W 0,09 m<sup>3</sup>  
120V / 60Hz  
3 x max. G9 / 7W  
Cable 59" / 1,5m

**monaco III**

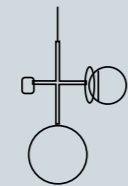

12" / 30 cm  
23" / 57 cm  
230V / 50Hz 27 lb | 12 kg  
3 x max. G9 / 7W 0,09 m<sup>3</sup>  
120V / 60Hz  
3 x max. G9 / 7W  
Cable 59" / 1,5m

**frame**

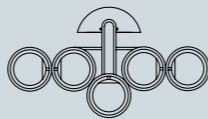

48" / 123 cm  
30" / 75 cm  
230V / 50Hz 44 lb | 20 kg  
5 x max. G9 / 7W 0,42 m<sup>3</sup>  
120V / 60Hz  
5 x max. G9 / 7W  
Cable 59" / 1,5m

**link**



39" / 100 cm  
39" / 100 cm  
230V / 50Hz 33 lb | 15 kg  
4 x max. G9 / 7W 0,85 m<sup>3</sup>  
120V / 60Hz  
4 x max. G9 / 7W  
Cable 59" / 1,5m

**link I**

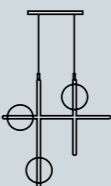

39" / 100 cm  
39" / 100 cm  
230V / 50Hz 26 lb | 12 kg  
3 x max. G9 / 7W 0,55 m<sup>3</sup>  
120V / 60Hz  
3 x max. G9 / 7W  
Cable 59" / 1,5m

**link II**

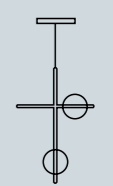

25" / 64 cm  
39" / 100 cm  
230V / 50Hz 20 lb | 9 kg  
2 x max. G9 / 7W 0,25 m<sup>3</sup>  
120V / 60Hz  
2 x max. G9 / 7W  
Cable 59" / 1,5m

**frame I**

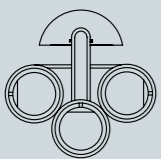

25" / 64 cm  
28" / 70 cm  
230V / 50Hz 34 lb | 15 kg  
3 x max. G9 / 7W 0,42 m<sup>3</sup>  
120V / 60Hz  
3 x max. G9 / 7W  
Cable 59" / 1,5m

**frame II**

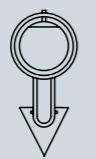

21" / 54 cm  
29" / 74 cm  
230V / 50Hz 15 lb | 7 kg  
1 x max. G9 / 7W 0,09 m<sup>3</sup>  
120V / 60Hz  
1 x max. G9 / 7W  
Cable 59" / 1,5m

**frame II**

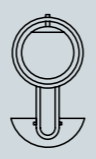

20" / 50 cm  
29" / 74 cm  
230V / 50Hz 15 lb | 7 kg  
1 x max. G9 / 7W 0,09 m<sup>3</sup>  
120V / 60Hz  
1 x max. G9 / 7W  
Cable 59" / 1,5m

**link III**

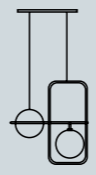

25" / 64 cm  
25" / 64 cm  
230V / 50Hz 15 lb | 7 kg  
2 x max. G9 / 7W 0,27 m<sup>3</sup>  
120V / 60Hz  
2 x max. G9 / 7W  
Cable 59" / 1,5m

**jules**

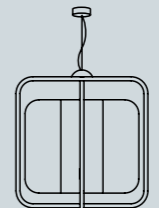

28" / 72 cm  
25" / 63 cm  
230V / 50Hz 19 lb | 9 kg  
E27/1x23W CFL 0,42 m<sup>3</sup>  
120V / 60Hz  
E26/1x18W CFL  
Cable 59" / 1,5m

**jules I**

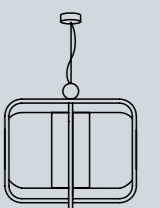

22" / 57 cm  
25" / 63 cm  
230V / 50Hz 19 lb | 9 kg  
E27/1x23W CFL 0,21 m<sup>3</sup>  
120V / 60Hz  
E26/1x18W CFL  
Cable 59" / 1,5m

**helio**

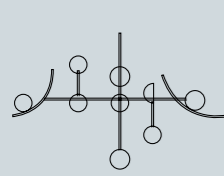

32" / 80 cm  
51" / 130 cm  
230V / 50Hz 18 lb | 8 kg  
7 x max. G9 / 7W 0,42 m<sup>3</sup>  
120V / 60Hz  
7 x max. G9 / 7W  
Cable 59" / 1,5m

**helio I**

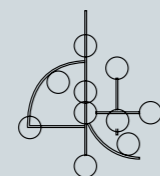

39" / 98 cm  
45" / 115 cm  
230V / 50Hz 9 lb | 9 kg  
9 x max. G9 / 7W 0,42 m<sup>3</sup>  
120V / 60Hz  
9 x max. G9 / 7W  
Cable 59" / 1,5m

**helio II**



20" / 50 cm  
14" / 35 cm  
230V / 50Hz 7 lb | 3 kg  
2 x max. G9 / 7W 0,13 m<sup>3</sup>  
120V / 60Hz  
2 x max. G9 / 7W  
Cable 59" / 1,5m

**jules II**

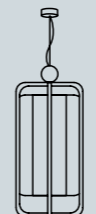

25" / 64 cm  
12" / 30 cm  
230V / 50Hz 13 lb | 6 kg  
E27/1x23W CFL 0,09 m<sup>3</sup>  
120V / 60Hz  
E26/1x18W CFL  
Cable 59" / 1,5m

**jules III**

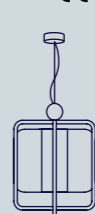

17" / 44 cm  
15" / 38 cm  
230V / 50Hz 11 lb | 5 kg  
E27/1x23W CFL 0,05 m<sup>3</sup>  
120V / 60Hz  
E26/1x18W CFL  
Cable 59" / 1,5m

**comb**

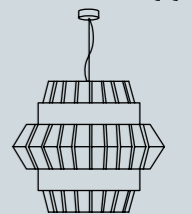

24" / 60 cm  
29" / 74 cm  
230V / 50Hz 35 lb | 16 kg  
E27/1x23W CFL 0,42 m<sup>3</sup>  
120V / 60Hz  
E26/1x18W CFL  
Cable 59" / 1,5m



comb I

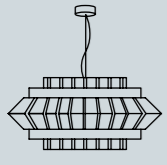

14" / 35 cm

30" / 75 cm

230V / 50Hz 35 lb | 16 kg  
● E27/1x23W CFL 0,23 m<sup>3</sup>  
120V / 60Hz  
● E26/1x18W CFL  
Cable 59" / 1,5m

loop

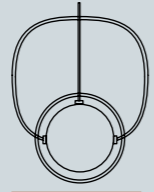

30" / 77 cm

22" / 55 cm

230V / 50Hz 4,4 lb | 2 kg  
● 1 x max. G9 / 7W 0,13 m<sup>3</sup>  
120V / 60Hz  
● 1 x max. G9 / 7W  
Cable 59" / 1,5m

loop I



29" / 74 cm

10" / 26 cm

230V / 50Hz 2,2 lb | 1 kg  
● 1 x max. G9 / 7W 0,05 m<sup>3</sup>  
120V / 60Hz  
● 1 x max. G9 / 7W  
Cable 59" / 1,5m

circus



29" / 73 cm

22" / 56 cm

230V / 50Hz 35 lb | 14 kg  
● E27/5x23W CFL 0,42 m<sup>3</sup>  
120V / 60Hz  
● E26/5x18W CFL  
Cable 59" / 1,5m

circus I

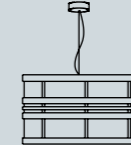

15" / 38 cm

22" / 56 cm

230V / 50Hz 28 lb | 13 kg  
● E27/5x23W CFL 0,25 m<sup>3</sup>  
120V / 60Hz  
● E26/5x18W CFL  
Cable 59" / 1,5m

circus II

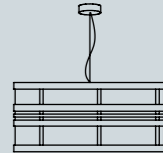

13" / 34 cm

26" / 65 cm

230V / 50Hz 30 lb | 14 kg  
● E27/5x23W CFL 0,23 m<sup>3</sup>  
120V / 60Hz  
● E26/5x18W CFL  
Cable 59" / 1,5m

loop II

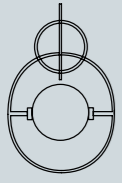

18" / 47 cm

12" / 31 cm

230V / 50Hz 2,2 lb | 1 kg  
● 1 x max. G9 / 7W 0,05 m<sup>3</sup>  
120V / 60Hz  
● 1 x max. G9 / 7W  
Cable 59" / 1,5m

magnolia

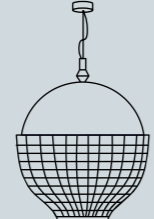

27" / 68 cm

26" / 65 cm

230V / 50Hz 19 lb | 9 kg  
● E27/1x23W CFL 0,42 m<sup>3</sup>  
120V / 60Hz  
● E26/1x18W CFL  
Cable 59" / 1,5m

magnolia I

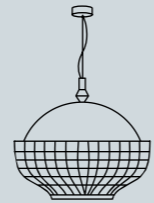

19" / 47 cm

26" / 65 cm

230V / 50Hz 19 lb | 9 kg  
● E27/1x23W CFL 0,21 m<sup>3</sup>  
120V / 60Hz  
● E26/1x18W CFL  
Cable 59" / 1,5m

circus III



26" / 66 cm

12" / 30 cm

230V / 50Hz 17 lb | 8 kg  
● E27/1x20W CFL 0,09 m<sup>3</sup>  
120V / 60Hz  
● E26/1x18W CFL  
Cable 59" / 1,5m

up

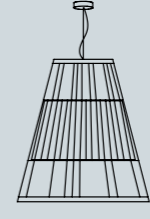

28" / 72 cm

22" / 55 cm

230V / 50Hz 19 lb | 9 kg  
● E27/1x23W CFL 0,42 m<sup>3</sup>  
120V / 60Hz  
● E26/1x18W CFL  
Cable 59" / 1,5m

up I

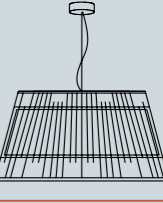

15" / 39 cm

27" / 68 cm

230V / 50Hz 34 lb | 15 kg  
● E27/1x23W CFL 0,25 m<sup>3</sup>  
120V / 60Hz  
● E26/1x18W CFL  
Cable 59" / 1,5m

magnolia II



23" / 59 cm

11" / 27 cm

230V / 50Hz 13 lb | 6 kg  
● E27/1x23W CFL 0,09 m<sup>3</sup>  
120V / 60Hz  
● E26/1x18W CFL  
Cable 59" / 1,5m

magnolia III

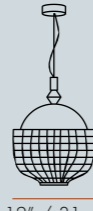

17" / 42 cm

12" / 31 cm

230V / 50Hz 11 lb | 5 kg  
● E27/1x20W CFL 0,05 m<sup>3</sup>  
120V / 60Hz  
● E26/1x15W CFL  
Cable 59" / 1,5m

carousel

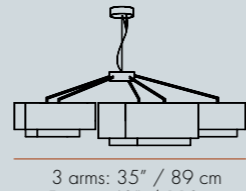

16" / 40 cm

3 arms: 35" / 89 cm  
5 arms: 43" / 110 cm

230V / 50Hz 44 lb | 20 kg  
● E27/3/5 x23W CFL 0,55 m<sup>3</sup>  
120V / 60Hz  
● E26/3/5x18W CFL  
Cable 59" / 1,5m

extrude

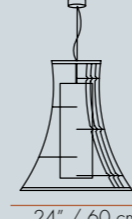

28" / 70 cm

24" / 60 cm

230V / 50Hz 19 lb | 9 kg  
● E27/1x23W CFL 0,42 m<sup>3</sup>  
120V / 60Hz  
● E26/1x18W CFL  
Cable 59" / 1,5m

star

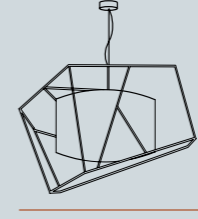

28" / 70 cm

32" / 80 cm

230V / 50Hz 13 lb | 6 kg  
● E27/1x23W CFL 0,42 m<sup>3</sup>  
120V / 60Hz  
● E26/1x18W CFL  
Cable 59" / 1,5m

star I

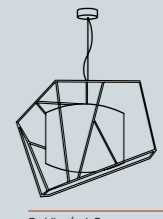

20" / 50 cm

24" / 60 cm

230V / 50Hz 13 lb | 6 kg  
● E27/1x23W CFL 0,28 m<sup>3</sup>  
120V / 60Hz  
● E26/1x18W CFL  
Cable 59" / 1,5m

carousel I

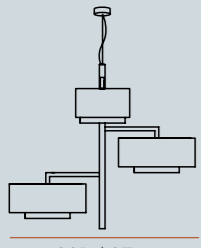

34" / 86 cm

38" / 97 cm

230V / 50Hz 44 lb | 20 kg  
● E27/3x23W CFL 0,55 m<sup>3</sup>  
120V / 60Hz  
● E26/3x18W CFL  
Cable 59" / 1,5m

expand

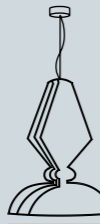

28" / 70 cm

20" / 50 cm

230V / 50Hz 17 lb | 8 kg  
● E27/1x23W CFL 0,42 m<sup>3</sup>  
120V / 60Hz  
● E26/1x18W CFL  
Cable 59" / 1,5m

revolution



28" / 70 cm

22" / 55 cm

230V / 50Hz 17 lb | 8 kg  
● E27/1x23W CFL 0,42 m<sup>3</sup>  
120V / 60Hz  
● E26/1x18W CFL  
Cable 59" / 1,5m

star II

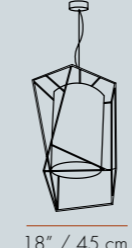

28" / 72 cm

18" / 45 cm

230V / 50Hz 11 lb | 5 kg  
● E27/1x23W CFL 0,17 m<sup>3</sup>  
120V / 60Hz  
● E26/1x18W CFL  
Cable 59" / 1,5m

star III

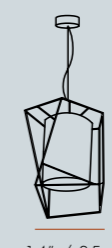

21" / 53 cm

14" / 35 cm

230V / 50Hz 8 lb | 4 kg  
● E27/1x20W CFL 0,18 m<sup>3</sup>  
120V / 60Hz  
● E26/1x15W CFL  
Cable 59" / 1,5m

spider

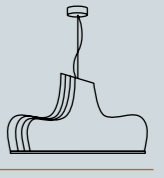

14" / 35 cm

28" / 70 cm

230V / 50Hz 17 lb | 8 kg  
● E27/1x23W CFL 0,26 m<sup>3</sup>  
120V / 60Hz  
● E26/1x18W CFL  
Cable 59" / 1,5m

spider I

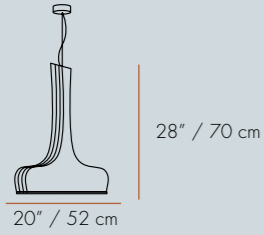

230V / 50Hz  
● E27/1x23W CFL 19 lb | 9 kg  
 0,42 m<sup>3</sup>  
120V / 60Hz  
● E26/1x18W CFL  
Cable  
59" / 1,5m

spider II

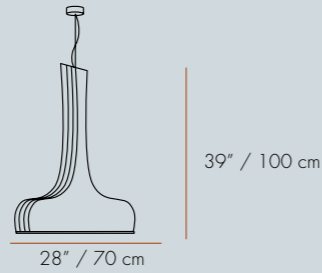

230V / 50Hz  
● E27/1x23W CFL 26 lb | 12 kg  
 0,59 m<sup>3</sup>  
120V / 60Hz  
● E26/1x18W CFL  
Cable  
59" / 1,5m

## table lamps

loop table II

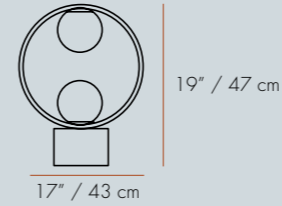

230V / 50Hz  
● 2 x max. G9 / 7W 6,6 lb | 3 kg  
 0,04 m<sup>3</sup>  
120V / 60Hz  
● 2 x max. G9 / 7W

magnolia table

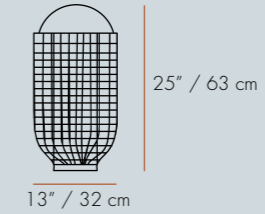

230V / 50Hz  
● E27/1x15W CFL 17 lb | 8 kg  
 0,09 m<sup>3</sup>  
120V / 60Hz  
● E26/1x13W CFL

circus table

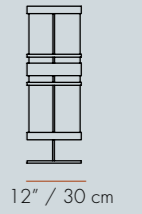

230V / 50Hz  
● E27/1x15W CFL 17 lb | 8 kg  
 0,09 m<sup>3</sup>  
120V / 60Hz  
● E26/1x13W CFL

monaco table

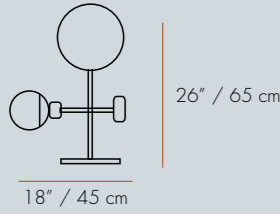

230V / 50Hz  
● 3 x max. G9 / 7W 29 lb | 14 kg  
 0,09 m<sup>3</sup>  
120V / 60Hz  
● 3 x max. G9 / 7W

monaco table

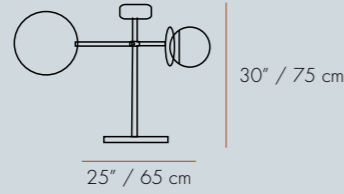

230V / 50Hz  
● 3 x max. G9 / 7W 30 lb | 15 kg  
 0,16 m<sup>3</sup>  
120V / 60Hz  
● 3 x max. G9 / 7W

frame table

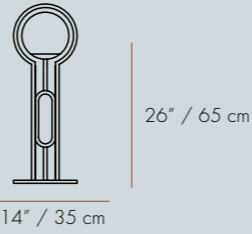

230V / 50Hz  
● 1 x max. G9 / 7W 26 lb | 12 kg  
 0,09 m<sup>3</sup>  
120V / 60Hz  
● 1 x max. G9 / 7W

up table

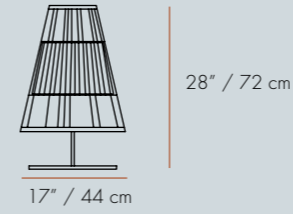

230V / 50Hz  
● E27/1x15W CFL 19 lb | 9 kg  
 0,16 m<sup>3</sup>  
120V / 60Hz  
● E26/1x13W CFL

extrude table I

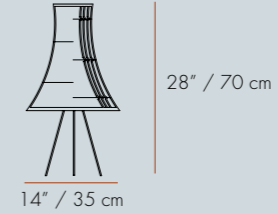

230V / 50Hz  
● E27/1x15W CFL 13 lb | 6 kg  
 0,09 m<sup>3</sup>  
120V / 60Hz  
● E26/1x13W CFL

extrude table II

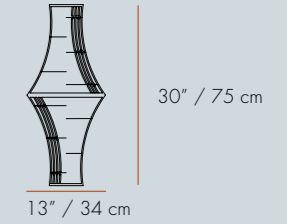

230V / 50Hz  
● E27/1x15W CFL 15 lb | 7 kg  
 0,09 m<sup>3</sup>  
120V / 60Hz  
● E26/1x13W CFL

helio table

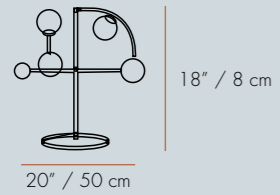

230V / 50Hz  
● 4 x max. G9 / 7W 11 lb | 5 kg  
 0,13 m<sup>3</sup>  
120V / 60Hz  
● 3 x max. G9 / 7W

globe table

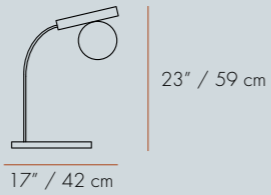

230V / 50Hz  
● 1 x max. G9 / 7W 35 lb | 16 kg  
 0,42 m<sup>3</sup>  
120V / 60Hz  
● 1 x max. G9 / 7W

jules table

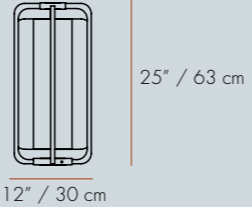

230V / 50Hz  
● E27/1x15W CFL 17 lb | 8 kg  
 0,09 m<sup>3</sup>  
120V / 60Hz  
● E26/1x13W CFL

star table

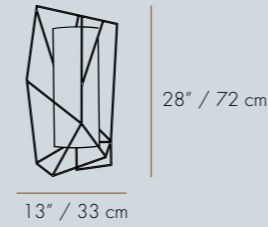

230V / 50Hz  
● E27/1x15W CFL 9 lb | 4 kg  
 0,16 m<sup>3</sup>  
120V / 60Hz  
● E26/1x13W CFL

spider table

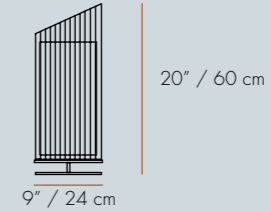

230V / 50Hz  
● E27/1x15W CFL 15 lb | 7 kg  
 0,09 m<sup>3</sup>  
120V / 60Hz  
● E26/1x13W CFL

## floor lamps

comb table

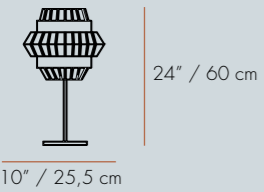

230V / 50Hz  
● E14/1x20W LED 4,4 lb | 2 kg  
 0,05 m<sup>3</sup>  
120V / 60Hz  
● E12/1x15W LED

loop table

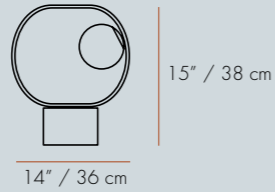

230V / 50Hz  
● 1 x max. G9 / 7W 4,4 lb | 2 kg  
 0,03 m<sup>3</sup>  
120V / 60Hz  
● 1 x max. G9 / 7W

loop table I

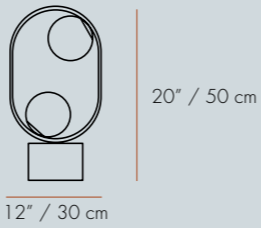

230V / 50Hz  
● 2 x max. G9 / 7W 6,6 lb | 3 kg  
 0,03 m<sup>3</sup>  
120V / 60Hz  
● 2 x max. G9 / 7W

monaco floor

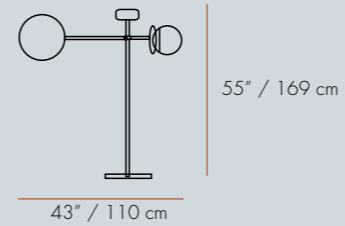

230V / 50Hz  
● 3 x max. G9 / 7W 26 lb | 25 kg  
 0,38 m<sup>3</sup>  
120V / 60Hz  
● 3 x max. G9 / 7W

frame floor

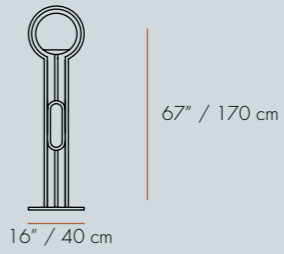

230V / 50Hz  
● 1 x max. G9 / 7W 26 lb | 25 kg  
 0,38 m<sup>3</sup>  
120V / 60Hz  
● 1 x max. G9 / 7W

helio frame

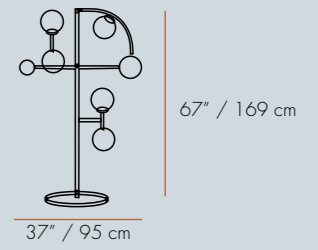





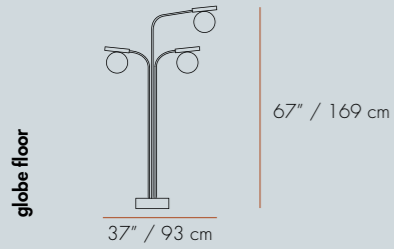

230V / 50Hz  
● 6 x max. G9 / 7W 24 lb | 10 kg  
 0,38 m<sup>3</sup>  
120V / 60Hz  
● 6 x max. G9 / 7W



globe floor







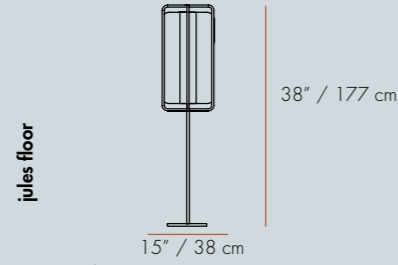

230V / 50Hz  19,85 lb | 9 kg  
 3 x max. G9 / 7W  0,24 m<sup>3</sup>

120V / 60Hz  
 3 x max. G9 / 7W  

jules floor









230V / 50Hz  26 lb | 12 kg  
 E27/1x23W CFL  0,38 m<sup>3</sup>

120V / 60Hz  
 E26/1x18W CFL  

comb II







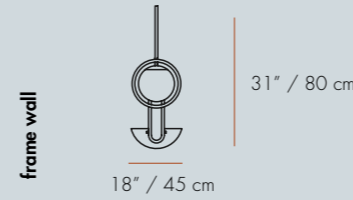

230V / 50Hz  30 lb | 14 kg  
 E27/1x23W CFL  0,65 m<sup>3</sup>

120V / 60Hz  
 E26/1x18W CFL  

frame wall







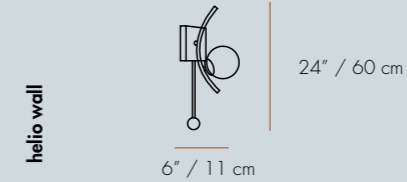

230V / 50Hz  22 lb | 10 kg  
 1 x max. G9 / 7W  0,17 m<sup>3</sup>

120V / 60Hz  
 1 x max. G9 / 7W  

helio wall



230V / 50Hz  7 lb | 3 kg  
 1 x max. G9 / 7W  0,09 m<sup>3</sup>

120V / 60Hz  
 1 x max. G9 / 7W  

globe wall

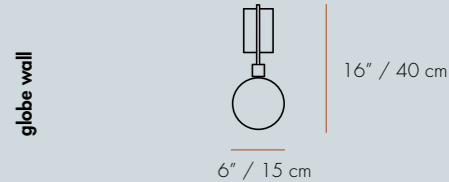





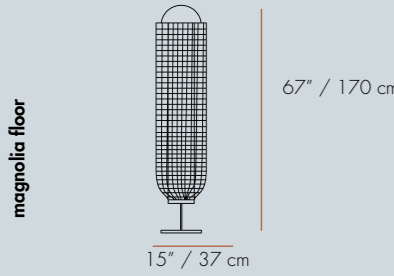

230V / 50Hz  2,2 lb | 1 kg  
 1 x max. G9 / 7W  0,02 m<sup>3</sup>

120V / 60Hz  
 1 x max. G9 / 7W  

magnolia floor







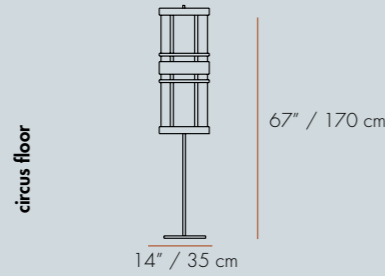

230V / 50Hz  26 lb | 12 kg  
 E27/2x23W CFL  0,38 m<sup>3</sup>

120V / 60Hz  
 E26/2x18W CFL  

circus floor



230V / 50Hz  37 lb | 17 kg  
 E27/6x15W CFL  0,38 m<sup>3</sup>

120V / 60Hz  
 E26/6x13W CFL  

up floor







230V / 50Hz  27 lb | 12 kg  
 E27/1x23W CFL  0,49 m<sup>3</sup>

120V / 60Hz  
 E26/1x18W CFL  

globe wall I





230V / 50Hz  4,4 lb | 2 kg  
 2 x max. G9 / 7W  0,05 m<sup>3</sup>

120V / 60Hz  
 2 x max. G9 / 7W  

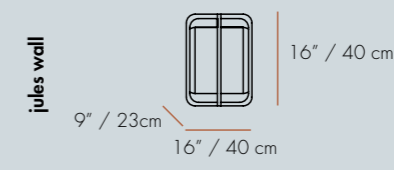
jules wall





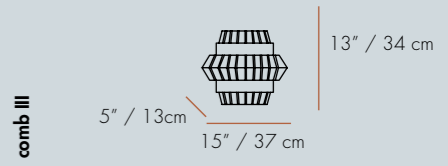

230V / 50Hz  8 lb | 4 kg  
 E14/1x20W CFL  0,05 m<sup>3</sup>

120V / 60Hz  
 E12/1x15W CFL  

comb III





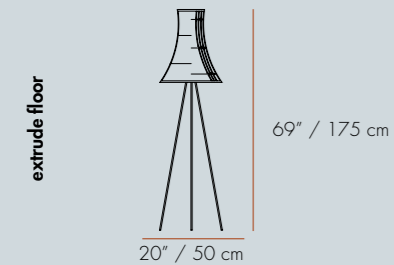

230V / 50Hz  11 lb | 5 kg  
 E14/1x20W CFL  0,05 m<sup>3</sup>

120V / 60Hz  
 E12/1x15W CFL  

extrude floor







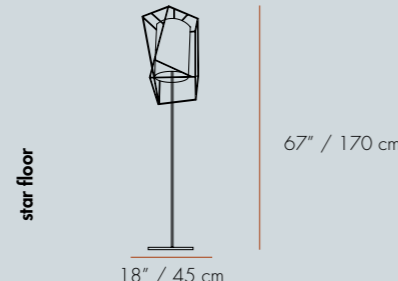

230V / 50Hz  26 lb | 12 kg  
 E27/1x23W CFL  0,57 m<sup>3</sup>

120V / 60Hz  
 E26/1x18W CFL  

star floor







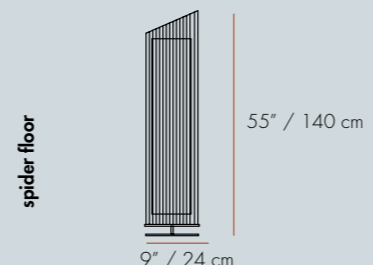

230V / 50Hz  19 lb | 9 kg  
 E27/1x23W CFL  0,38 m<sup>3</sup>

120V / 60Hz  
 E26/1x18W CFL  

spider floor







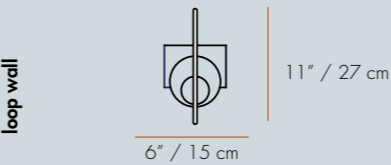

230V / 50Hz  26 lb | 12 kg  
 E27/2x23W CFL  0,38 m<sup>3</sup>

120V / 60Hz  
 E26/2x18W CFL  

loop wall







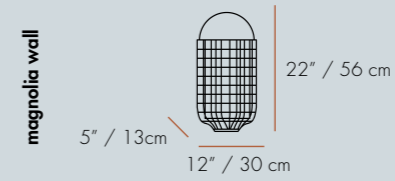

230V / 50Hz  2,2 lb | 1 kg  
 1 x max. G9 / 7W  0,02 m<sup>3</sup>

120V / 60Hz  
 1 x max. G9 / 7W  

magnolia wall







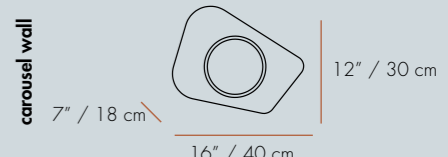

230V / 50Hz  8 lb | 4 kg  
 E14/1x20W CFL  0,05 m<sup>3</sup>

120V / 60Hz  
 E12/1x15W CFL  

carousel wall







230V / 50Hz  11 lb | 5 kg  
 E27/1x20W CFL  0,05 m<sup>3</sup>

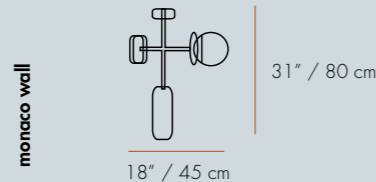

120V / 60Hz  
 E26/1x15W CFL  

## wall lamps

monaco wall



230V / 50Hz  22 lb | 10 kg  
 1 x max. G9 / 7W  0,17 m<sup>3</sup>

120V / 60Hz  
 1 x max. G9 / 7W  

monaco wall







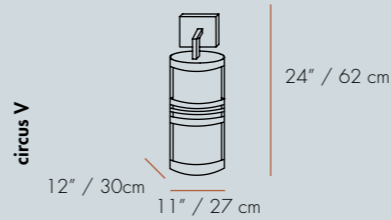

230V / 50Hz  11 lb | 5 kg  
 2 x max. G9 / 4W  0,05 m<sup>3</sup>

120V / 60Hz  
 2 x max. G9 / 4W  

circus V







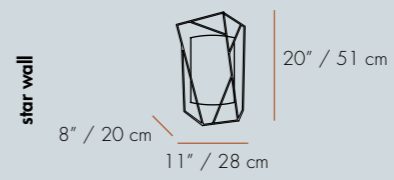

230V / 50Hz  17 lb | 8 kg  
 E27/1x20W CFL  0,09 m<sup>3</sup>

120V / 60Hz  
 E26/1x18W CFL  

star wall







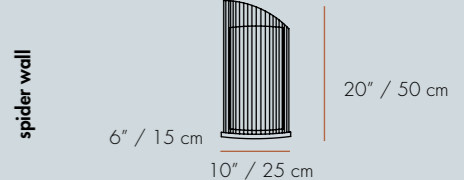

230V / 50Hz  6 lb | 3 kg  
 E14/1x20W CFL  0,05 m<sup>3</sup>

120V / 60Hz  
 E12/1x15W CFL  

spider wall



230V / 50Hz  11 lb | 5 kg  
 E14/1x20W CFL  0,05 m<sup>3</sup>

120V / 60Hz  
 E12/1x15W CFL  

# finishings

## cords fios

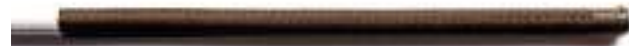

brown textile cord<sup>1</sup>  
fio têxtil castanho



black textile cord<sup>2</sup>  
fio têxtil preto



transparent rubber cord<sup>3</sup>  
fio de borracha transparente



yellow textile cord<sup>4</sup>  
fio têxtil amarelo



black and white textile cord<sup>4</sup>  
fio têxtil preto e branco



red and blue textile cord<sup>4</sup>  
fio têxtil vermelho e azul

## abat-jours



cotton  
algodão



linen  
linho

<sup>1</sup> standard for all suspension lamps (except black ones)  
standard para candeeiros de suspensão (excepto pretos)

<sup>2</sup> standard for black suspension lamps  
standard para candeeiros de suspensão pretos

<sup>3</sup> standard for all table and floor lamps  
standard para candeeiros de mesa e chão

<sup>4</sup> available on extra charge  
disponível com custo adicional

## cup copo

cup color matches the lamp  
cor do copo igual à do candeeiro  
Ø: 105 cm / 59"  
h: 35 cm / 14"

Frame collection suspension lamp cup  
copo da coleção dos candeeiros de suspensão Frame



standard suspension lamp cup  
copo standart dos candeeiros de suspensão



Helio and Helio I suspension lamp cup  
copo dos candeeiros de suspensão Helio e Helio I



## lacquered metal metal lacado



white

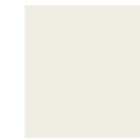

ivory



taupe



dream



emerald



moss



jade



mint



cobalt



lipstick



yellow sun



lilac



brown



black



copper color



salmon



spotted brown\*

## polished, satin and oxidized metal metal polid, satinado e oxidado

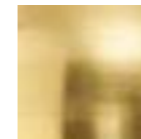

polished brass  
latão polido



satin brass  
latão satinado

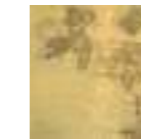

oxidized brass  
latão oxidado

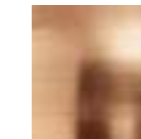

polished copper  
cobre polido



satin copper  
cobre satinado

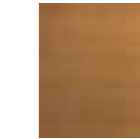

bronze  
escovado



polished nickel  
níquel polido



polished nickel  
níquel polido

## laquered wood madeira lacada



aloe



blossom



wine



black



terrazzo

\* spotted brown is a painted color  
spotted brown é uma cor pintada

POLISHED AND SATIN METAL PIECES:  
this product is handmade; any small stain or roughness  
is a feature of the product, not a defect.

PEÇAS EM METAL POLIDO E SATINADO:  
este produto é feito artesanalmente; qualquer pequena  
rugosidade ou mancha é uma característica, não um defeito.

**Sample box available.**  
**Caixa de amostras disponível.**







Rua Fernando Palha, n.º 56-A  
Santa Maria dos Olivais  
1950-132 Lisboa - Portugal

[info@utulamps.com](mailto:info@utulamps.com)

[www.utulamps.com](http://www.utulamps.com)

photography by

João Frazão

graphic project by

Utu creative team

cover illustration by

Rita Ramos

© 2019 Utu Soulful Lighting. All rights reserved.

Co-financiado por:



união europeia  
Fundo Social Europeu

