



NEW COLLECTION

---

2 0 2 1

IPMlight



3

4



IPMlight

## *Gulliver*

*Ring giganti vestiti in eco-pelle mocha e diffusore Led in polycarbonato bianco.  
Giant rings dressed in mocha eco-leather and white polycarbonate Led diffuser.*

*Гигантские кольца облачены в коззам цвета мока.  
Светодиодная лента скрыта под диффузором из белого поликарбоната.*



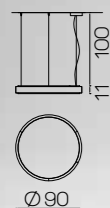

Art. 2230D90  
 Ø 90 cm H 11 cm  
 + 100 cm steel cable  
 Strip Led 14,4 W/m 4000°K  
 4230 lumen (Kg 15)

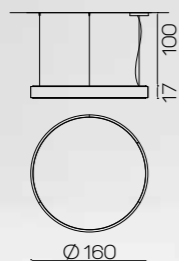

Art. 2230D160  
 Ø 160 cm H 17 cm  
 + 100 cm steel cable  
 Strip Led 14,4 W/m 4000°K  
 15000 lumen (Kg 20)

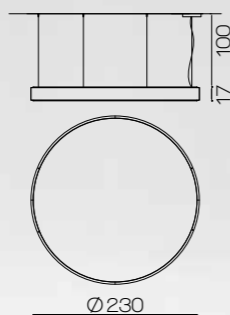

Art. 2230D230  
 Ø 230 cm H 17 cm  
 + 100 cm steel cable  
 Strip Led 14,4 W/m 4000°K  
 21000 lumen (Kg 30)

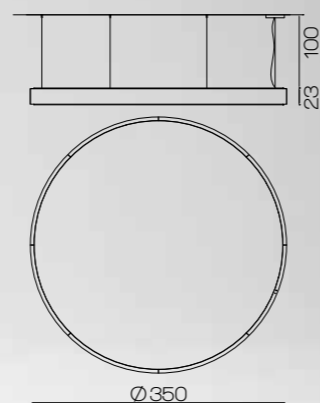

Art. 2230D350  
 Ø 350 cm H 23 cm  
 + 100 cm steel cable  
 Strip Led 14,4 W/m 4000°K  
 33000 lumen (Kg 50)



NEW YORK



LONDON



TOKYO





Art. 2248/CH6  
 L 145 x 42 cm H min 15 cm  
 H tot 100 cm  
 6 x G9 x Led (Kg 20)

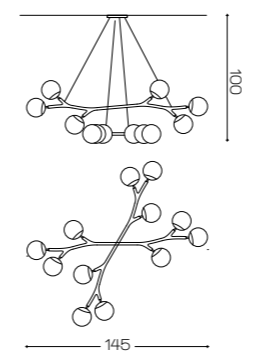

Art. 2248/CH12  
 Ø 145 cm Htot 100 cm  
 12 x G9 x Led (Kg 28)

## Buds

*Rami in fusione di ottone sabbiato sostengono delicate sfere in Vetro di Murano, la loro sfumatura crea atmosfere uniche di estrema eleganza.*

*Branches in blasted-brass-fusion support delicate spheres in Murano glass, their nuance creates unique atmospheres of extreme elegance.*

*Изящные шары из муранского стекла лежат на ветвях из литой латуни в пескоструйной обработке.*

*Их изысканные оттенки создают неповторимую элегантную атмосферу.*







Art. 2248/A2  
L 30 H 53 cm Sp 16 cm  
2 x G9 x Led (Kg 8)



Art. 2248/A3  
L 42 H 73 cm Sp 16 cm  
3 x G9 x Led (Kg 10)



Art. 2248/CH3  
L 42 x 25 cm H 78 cm  
+ 100 cm steel cable  
3 x G9 x Led (Kg 15)





# Organic

*Anello in soft gold con decorazioni in vetro.*

*Ring in soft gold finish with glass decorations.*

*Круг в цвете "светлое золото" с украшениями из стекла.*



13

14

IPMlight

Art. 2178/CH8  
Ø max 138 cm H 25 cm  
+ 100 cm Steel cable  
8 x G9 x Led (Kg 15)



## Organic

*Anello in oro pallido con decorazioni in vetro.*



Art. 2178/CH4  
 Ø max 90 cm H 25 cm  
 + 100 cm Steel cable  
 4 x G9 x Led (Kg 12)

Art. 2178/A1  
 L max 60 cm H 30 cm SP 27 cm  
 1 x G9 x Led (Kg 6)



*Ring in soft gold finish with glass decorations.*

*Круг в цвете "светлое золото" с украшениями из стекла.*

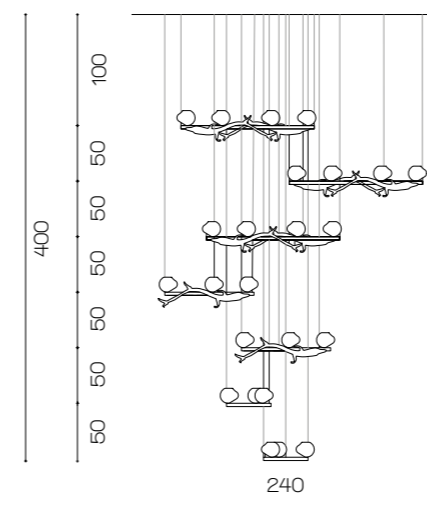

Art. 2178/CH38  
 L 240 x 138 cm H 400 cm  
 38 x G9 x Led

Art. 2178/CH8  
 Ø max 138 cm H 25 cm  
 + 100 cm Steel cable  
 8 x G9 x Led (Kg 15)





Art. 2220/A1  
L 16 cm H 48 cm Sp 17 cm  
1 x G9 x Led (Kg 2)

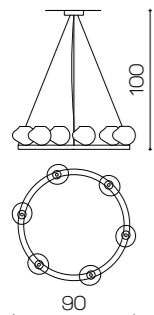

Art. 2179/CH6  
Ø max 90 cm H 17 cm  
+ 83 cm Steel cable  
6 x G9 x Led (Kg 15)

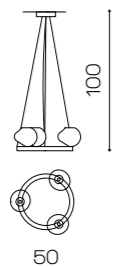

Art. 2179/CH3  
Ø max 50 cm H 17 cm  
+ 83 cm Steel cable  
3 x G9 x Led (Kg 12)



Art. 2220/A2  
L 26 cm H 61 cm  
Sp 17 cm  
2 x G9 x Led (Kg 3)



Art. 2220/A3  
L 42 cm H 70 cm  
Sp 17 cm  
3 x G9 x Led (Kg 4)



Art. 2220/A5  
L 42 cm H 123 cm  
Sp 17 cm  
5 x G9 x Led (Kg 6)



Art. 2179/CH8  
Ø max 130 cm H 17 cm  
+ 83 cm Steel cable  
8 x G9 x Led (Kg 15)



Art. 2219/A1  
L 9 cm H 65 cm  
Sp 10 cm  
1 x G9 x Led (Kg 2)



Art. 2219/A2  
L 20 cm H 78 cm  
Sp 10 cm  
2 x G9 x Led (Kg 4)



Art. 2219/A3  
L 31 cm H 86 cm  
Sp 10 cm  
3 x G9 x Led (Kg 4)



Art. 2219/A5  
L 31 cm H 140 cm  
Sp 10 cm  
5 x G9 x Led (Kg 8)



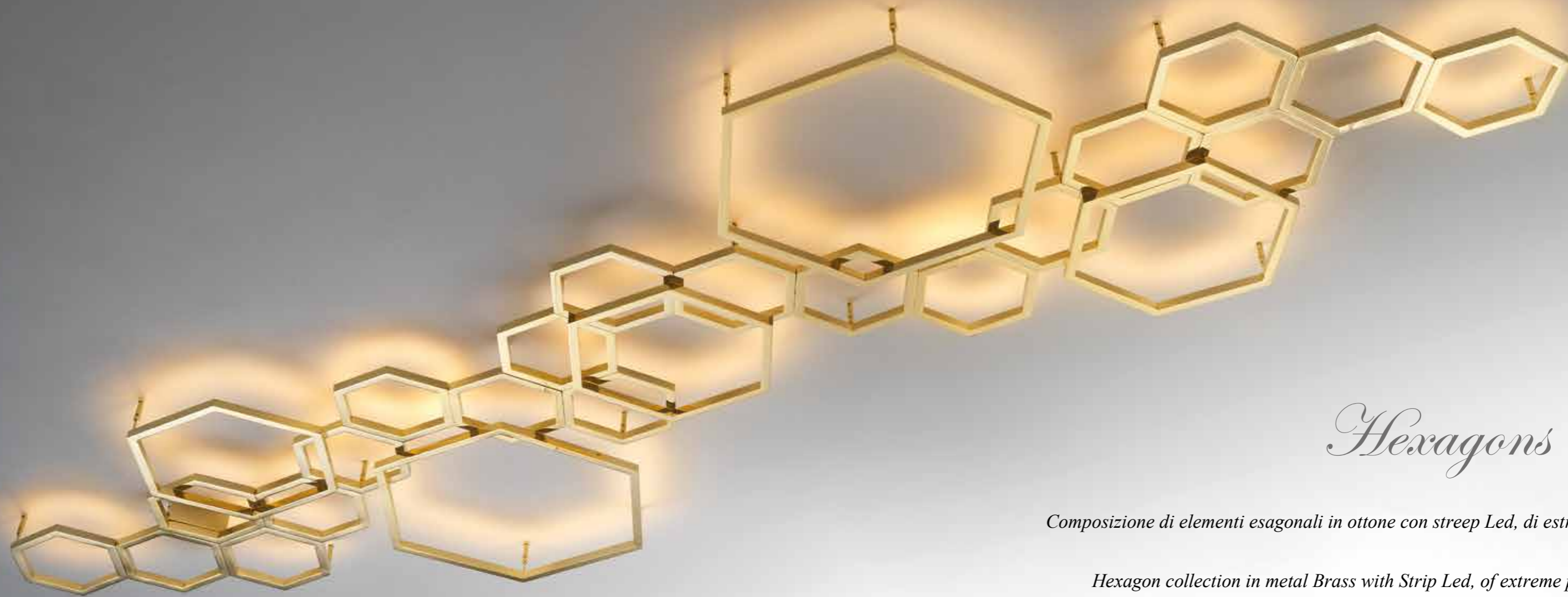

## Hexagons

*Composizione di elementi esagonali in ottone con streep Led, di estrema purezza e poetica eleganza.*

*Hexagon collection in metal Brass with Strip Led, of extreme purity and poetic elegance.*

*Композиция из шестиугольных элементов в латуни со светодиодной лентой – воплощение абсолютной чистоты линий и поэтической элегантности*

21

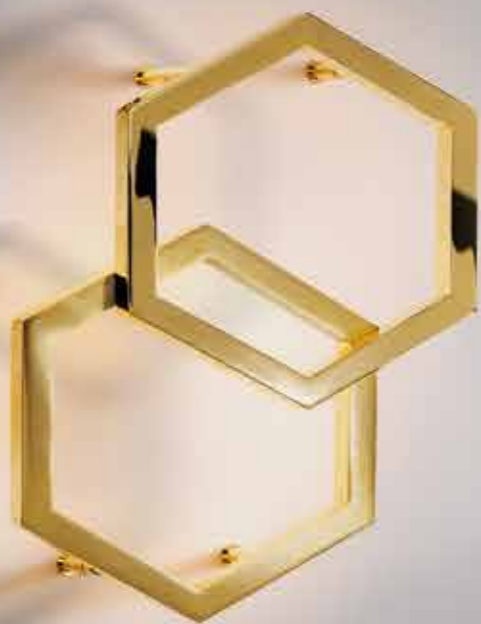

Art. 2122  
L 30 cm H 43 cm Sp 10 cm  
Led Strip 3000°K 1700 Lumen  
alimentatore in remoto (Kg 5)

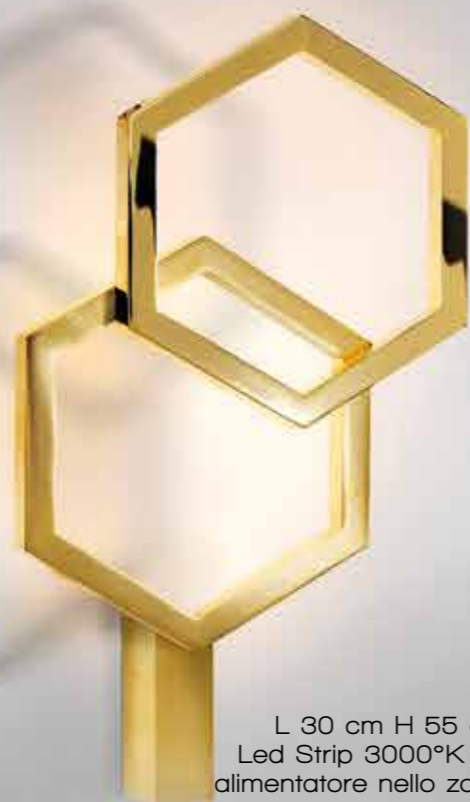

Art. 2122/BIS  
L 30 cm H 55 cm Sp 10 cm  
Led Strip 3000°K 1700 Lumen  
alimentatore nello zoccolo (Kg 5)

22



Art. 2121/LARGE  
L 364 cm H 124 cm Sp 10 cm  
Led Strip 3000°K 11000 Lumen  
Dimmable with remote control 160 watt (30 Kg)

IPMlight



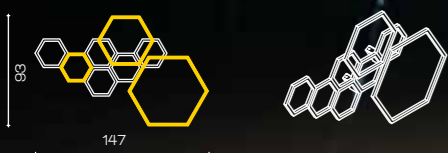

Art. 2121/LU  
 L 147 cm H 93 cm Sp 10 cm  
 Led 3000 K° 4400 Lumen

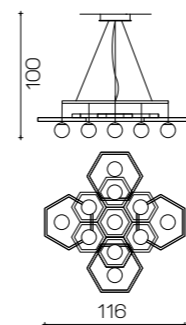

Art. 2123/CH11/LU  
 Ø 116 cm H tot. 100 cm  
 11 x G9 x Led 10W (Kg 18)



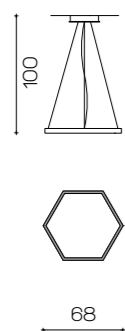

Art. 2125  
L 68 cm H tot. 100 cm  
Led 3000 K° 1500 Lumen

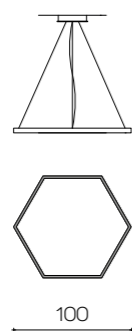

Art. 2126  
L 100 cm H tot. 100 cm  
Led 3000 K° 3100 Lumen

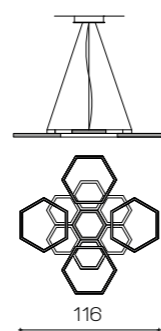

Art. 2124/LU  
Ø 116 cm H tot. 100 cm  
Led 3000 K° 7000 Lumen

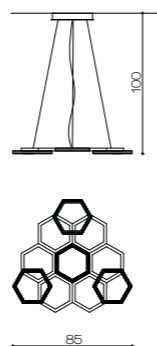

Art. 2124/D90  
Ø 90 cm H tot 100 cm  
3000°K 3750 Lumen (Kg 18)



Art. 2124/NL  
Ø 116 cm H tot 100 cm  
Led 3000 K° 7000 Lumen



27



Art. 2173/A1+1  
L 10 cm H 43 cm  
Sp 12 cm  
2 x G9 x Led (Kg 6)

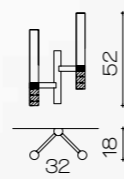

Art. 2173/A2+2  
L 32 cm H 52 cm  
Sp 18 cm  
4 x G9 x Led (Kg 8)



28

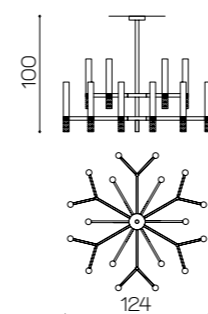

Art. 2173/CH18+18  
Ø 124 cm H 100 cm  
36 x G9 x Led (Kg 70)

## Marble

*Lampadario con elementi di marmo di Carrara e vetro, una combinazione esclusiva che crea atmosfere uniche.*

*Chandelier with elements in Carrara marble and glass, an exclusive combination that creates unique atmospheres.*

*Люстра с элементами из каррарского мрамора и стекла - уникальное сочетание, создающее неповторимую атмосферу.*





29

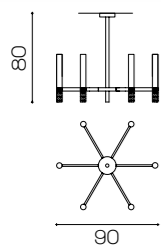

Art. 2173/CH6+6  
 Ø 90 cm H 80 cm  
 12 x G9 x Led (Kg 25)



30

IPMlight

2173/RETT/CH11+11  
 L 175 x 5 cm H 90 cm  
 22 x G9 x Led (Kg 28)



31

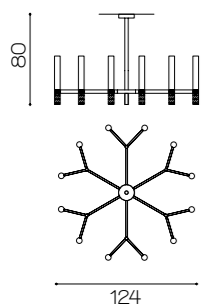

Art. 2173/CH12+12  
 Ø 124 cm H 80 cm  
 24 x G9 x Led (Kg 30)

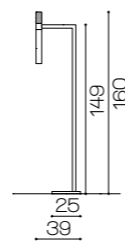

Art. 2173/FL  
 L 39 cm Base Ø 25 cm H 160 cm  
 2 x G9 x Led



32

Art. 2176/G/white  
 L 40 cm Ø 40 cm Sp 14 cm  
 1 x G9 x Led

Art. 2176/P/white  
 L 28 cm Ø 28 cm Sp 12 cm  
 1 x G9 x Led





Art.2253/T  
Base 36 x 9 cm D 35 cm H 45 cm  
1 x E27 x Led





Art. 2218/CH12+12  
 Ø 124 cm H 100 cm  
 24 x G9 x Led (Kg 25)

Art. 2218/CH6+6  
 Ø 90 cm H 100 cm  
 12 x G9 x Led (Kg 20)



## Pipe

*Lampadario con doppio cilindro in vetro borosilicato satinato e trasparente, in finitura in oro pallido.*

*Chandelier with double transparent and satin borosilicate glass cylinders, structure in soft gold finishing.*

*Люстра с двойными боросиликатными стеклянными цилиндрами как в прозрачном, так и в сатиновом вариантах, выполнена в отделке металла «oro pallido» – «светлое золото».*

Art. 2218/CH18+18  
 Ø 124 cm H 120 cm  
 36 x G9 x Led (Kg 40)





Art. 2218/RETT/CH11+11  
L 175 x 5 cm H 110 cm  
22 x G9 x Led (Kg 25)



Art. 2218/A2+2  
L 32 cm H 75 cm Sp 18cm  
4 x G9 x Led (Kg 4)



Art. 2218/A1+1  
L 9 cm H 65 cm Sp 12 cm  
2 x G9 x Led (Kg 2)

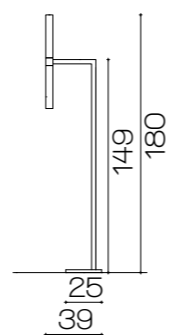

Art. 2218/FL  
L 39 cm Base Ø 25cm  
H 180 cm  
2 x G9 x Led



Art. 2218/A1+1  
L 65 cm H 9 cm Sp 12 cm  
2 x G9 x Led (Kg 2)



39

## Carrara

*Lampadario tondo in oro pallido e diffusori in Marmo bianco di Carrara.*

*Round brass chandelier in soft gold brass and diffuser elements in white Carrara Marble.*

*Круглая люстра в отделке металла "oro pallido"*

*«светлое золото» с диффузорами из белого Каррарского мрамора.*

Art. 2211/CH18  
 Ø 118 cm Htot 140 cm  
 18 x G9 x Led (30 Kg)



40



IPMlight

Art. 2211/CH12  
 Ø 118 cm H 30 Htot 100 cm  
 12 x G9 x Led (25 Kg)





41



Art. 2211/A1  
L. 15 cm H 31 cm  
Sp 10 cm  
1 x G9 x Led (5 Kg)

Art. 2211/CH6  
Ø 55 cm H 30  
Htot 100 cm  
6 x G9 x Led (15 Kg)



42



Art. 2211/T  
L 54 cm Base Ø 25 cm  
H 34 cm  
1 x E14 x Led

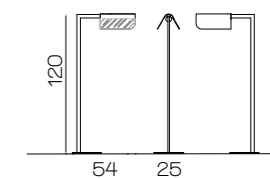

Art. 2211/FL  
L 54 cm Base Ø 25 cm  
H 120 cm  
1 x E14 x Led



Art. 2212/CH6  
 Ø 55 cm H 30 cm  
 H tot 100 cm  
 6 x G 9x Led (15 Kg)



## *Damsels*

*Lampadario tondo in oro pallido e vetri molati a mano con incisioni di donzelle danzanti.*

*Round brass chandelier in soft gold brass and hand-cutted dancing damsels engraving on glass.*

*Круглая люстра в отделке металла "oro pallido" – «светлое золото» украшена стеклами с гравировкой танцующих балерин ручной работы.*

Art. 2212/CH12  
 Ø 118 cm H 30 cm  
 H tot 100 cm  
 12 x G9 x Led (25 Kg)





Art. 2212/A1  
L 15 cm H 31 cm  
Sp 10 cm  
1 x G9 x led (5 Kg)



Art. 2212/CH18  
Ø 118 cm H tot 140 cm  
18 x G9 x Led (30 Kg)





*Corpi illuminanti in finitura oro  
pallido e sfere in cristallo  
italiano molato a mano.*

*Light fixtures in soft gold finish with  
hand-cut Italian crystal spheres.*

*Светильники в отделке «светлое  
золото» с хрустальными шарами  
ручной гравировки.*

Art. 2164/A  
L 12 cm H 46 cm Sp 14 cm  
1 x G9 x Led (Kg 6)



Art. 2177/CH16  
Ø 112 cm H 15 cm  
+ 100 cm Steel cable  
16 x G9 x Led + 3 GU10 Led (Kg 30)





Art. 2177/CH6/NB  
Ø 60 cm H 16 cm  
H tot 100 cm  
6 x G9 x Led (Kg 12)



Art. 2177/A1/NB  
L 12 cm H 20 cm Sp 21 cm  
1 x G9 x Led (Kg 2)

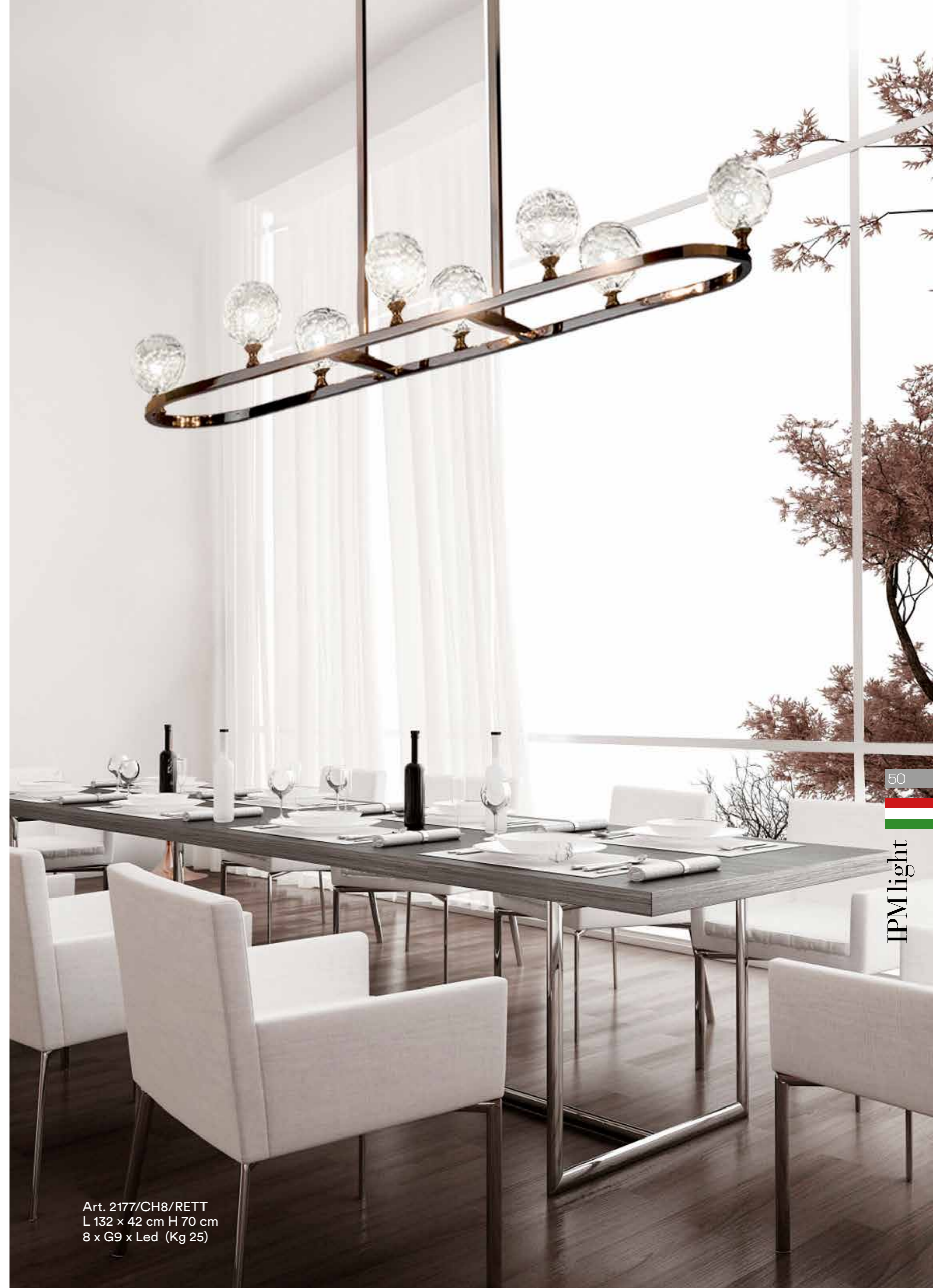

Art. 2177/CH8/RETT  
L 132 x 42 cm H 70 cm  
8 x G9 x Led (Kg 25)





Art. 2217/T  
L 31 x 16 cm H 63 cm  
2 x G9 x Led

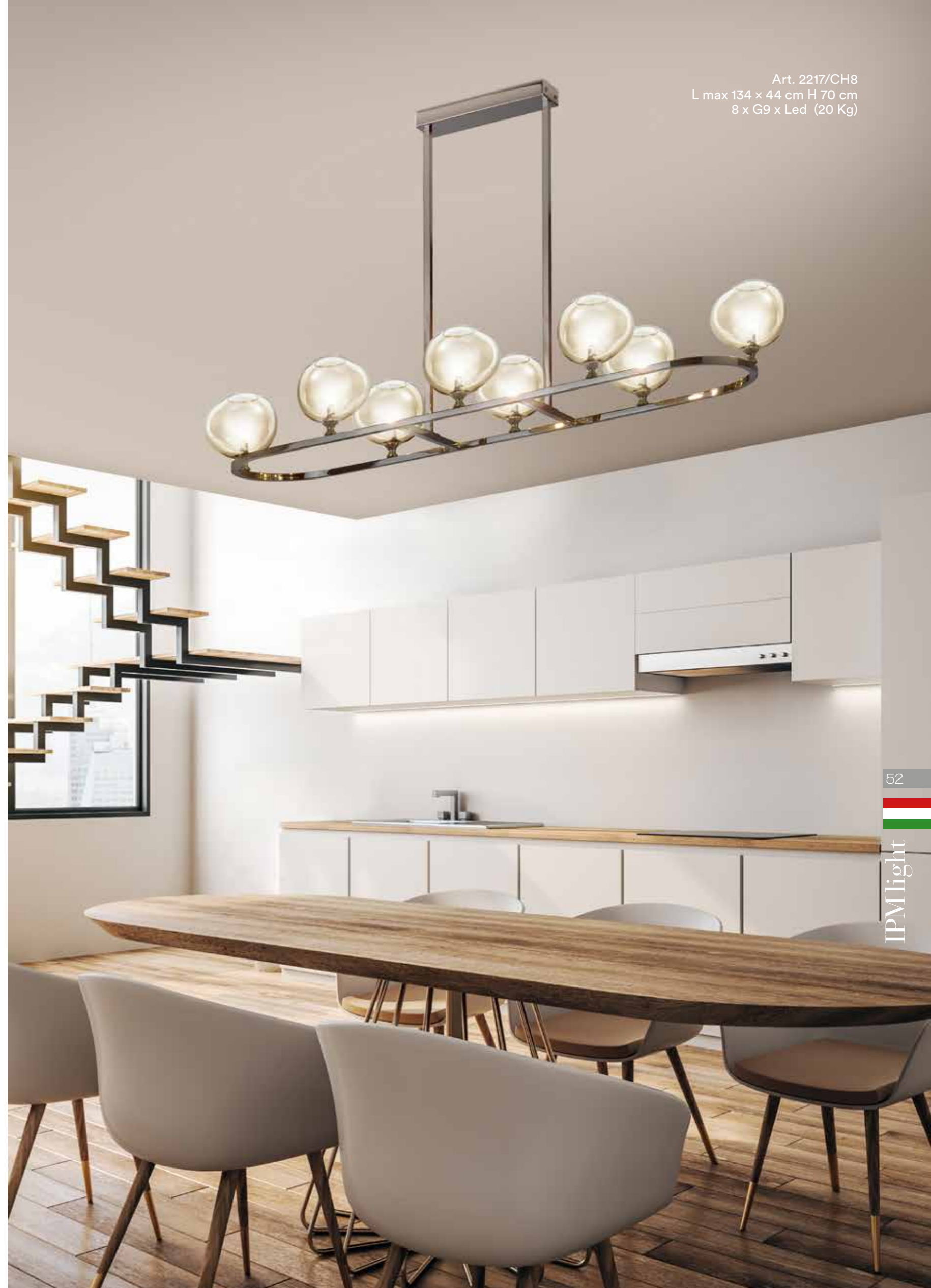

Art. 2217/CH8  
L max 134 x 44 cm H 70 cm  
8 x G9 x Led (20 Kg)



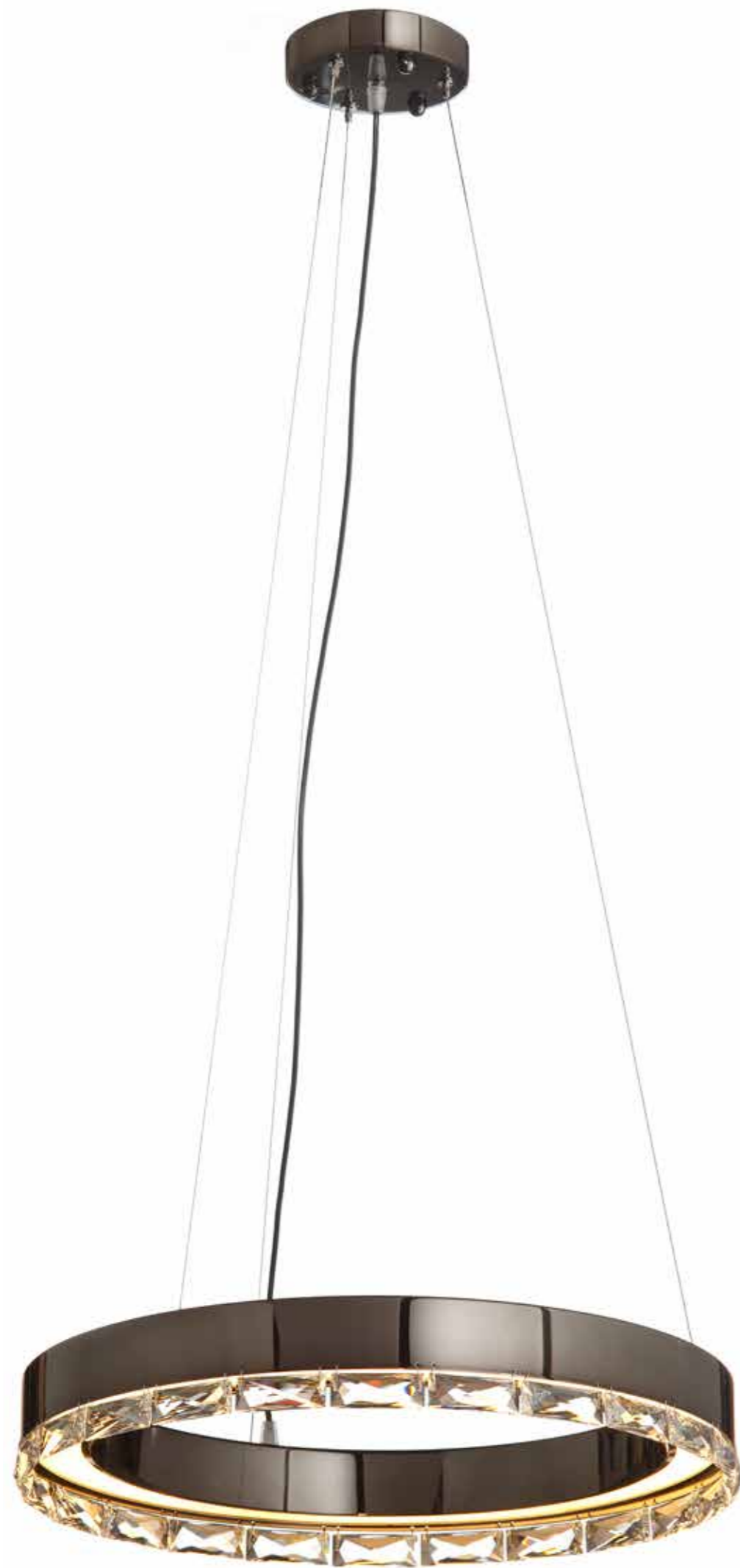

*Rings with led and Swarovski Elements*

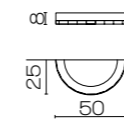

Art. 2103/A  
L 50 cm H 8 cm  
Sp 25 cm  
Strip led 3000 k  
Lumen 1570 closed top

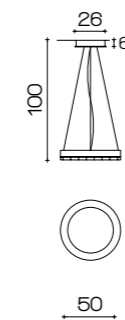

Art. 2103/P/NN  
Ø 50 cm H 8 cm  
100 cm steel cable  
Strip Led 3200 K  
Lumen 3240 43W (Kg 15)

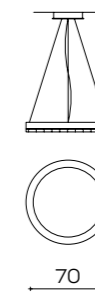

Art. 2103/M/NN  
Ø 70 cm H 8 cm  
100 cm steel cable  
Strip Led 3200 K  
Lumen 4860 64W (Kg 15)

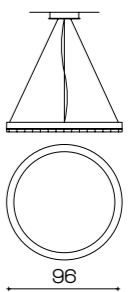

Art. 2103/G/NN  
Ø 96 cm H 8 cm  
100 cm steel cable  
Strip Led 3200 K  
Lumen 7020 93W (Kg 18)





Art. 2103/G/NN/bis  
 Ø 96 cm H 5 cm + 100 cm steel cable  
 Strip Led 3200 K Lumen 5793 85W (Kg 18)



Art. 2103/M/NN/bis  
 Ø 70 cm H 5 cm + 100 cm steel cable  
 Strip Led 3200 K Lumen 3968 58W (Kg 15)



Art. 2103/P/NN/bis  
 Ø 50 cm H 5 cm + 100 cm steel cable  
 Strip Led 3200 K Lumen 2740 40W (Kg 15)

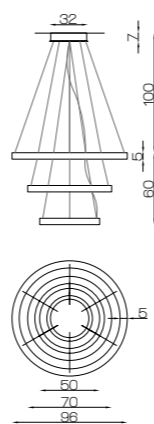
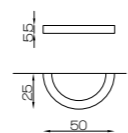

Art. 2103/A/bis  
 L 50 cm H 5,5 cm Sp 25 cm  
 Strip led 3000 k  
 Lumen 1570  
 CLOSED TOP (Kg 5)

2103/PMG/bis  
 Ø 96 cm Hmin.60 cm +  
 100 cm steel cable  
 Strip Led 3200 K  
 Lumen 15554 (kg 45)







## *Fringes*

*Anello in metallo in finitura nikel nero e Led,  
passamaneria sfumata in tinta blu colorata a mano  
frutto di eccellente maestria artigianale.*

*Ring chandelier with led light and a blue fringes  
trimming colored by hand, result of excellent craftsmanship.*

*Плод настоящего ремесленного мастерства:  
металлическое кольцо в отделке металла  
черный никель со светодиодной лентой и тканевой бахромой  
с окрашенной вручную градацией синего.*





Art. BA802  
L 35 x 35 cm H 50 cm

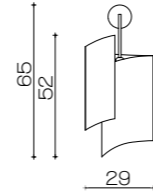

Art. 2233/A  
L 29 cm H 52 cm  
H tot. 65 cm  
1 x E27 x Led (Kg 8)

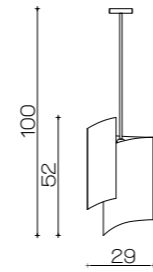

Art. 2233/S  
L 29 cm H 52 cm  
H tot. 100 cm  
1 x E27 x Led (Kg 8)

Art. BA803  
L 35 x 35 cm H 46 cm



Art. BA801  
L 60 x 35 cm H 50 cm



Art. 2233/S1  
Ø 29 cm H 52 cm  
H tot. 210 cm  
1 x E27 x Led (Kg 9)

Art. 2233/G  
Ø 96 cm H 45 cm + 100 cm steel cable  
Strip Led 3200 K Lumen 5793 85W (Kg 10)





61

Art. 2249/CH  
Ø 60 cm H 13 cm + 100cm steel cable  
6 x G9 x Led (Kg 22)



62

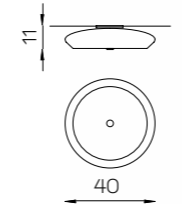

Art. 2249P  
Ø 40 cm H 11 cm  
4 x G9 x Led (Kg 10)

Art. 2249  
Ø 60 cm H 14 cm  
6 x G9 x Led (Kg 20)







Art. 2167/P  
 ø 20 cm H 9 cm  
 3 x G9 x Led (Kg 6)

Art. 2167/M  
 ø 38 cm H 9 cm  
 6 x G9 x Led (Kg 10)

Art. 2167/G  
 ø 50 cm H 9 cm  
 8 x G9 x Led (Kg 10)

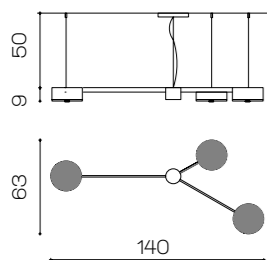

Art. 2166/CH9  
 L 140 x 63 cm H 9 cm  
 +50 steel cable  
 9 x G9 x Led (Kg 18)

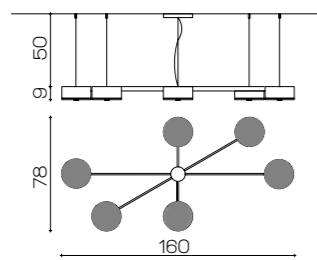

Art. 2166/CH18  
 L 160 x 78 cm H 9 cm  
 +50 steel cable  
 18 x G9 x Led (Kg 18)

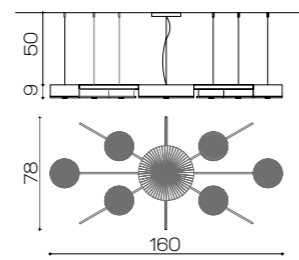

Art. 2166/CH24  
 L 160 x 78 cm H 9 cm  
 +50 steel cable  
 24 x G9 x Led (Kg 18)

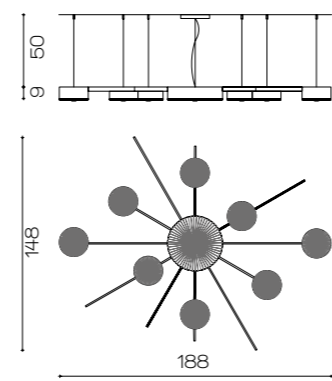

Art. 2166/CH30  
 L 188 x 148 cm H 9 cm  
 +50 steel cable  
 30 x G9 x Led (Kg 30)



## Moon

*Dischi in cristallo italiano molato a mano "taglio Visù"  
 si susseguono in questa composizione estremante dinamica ed elegante.*

*Extremely dynamic and elegant composition of discs  
 in Italian hand-milled crystal 24K with "visù" cut.*

*Динамичная и элегантная композиция из хрустальных  
 дисков с гравировкой «visù».*







*Cassiopea*

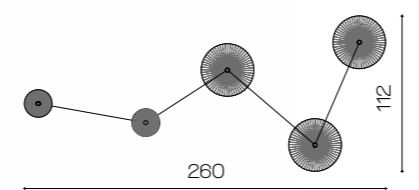

Art. 2166/WALL  
L 260 x 112 cm H 9 cm  
24 x G9 x Led (Kg 20)

Art. 2165/CH30/WALL LAMP  
L 188 x 148 cm H 9 cm  
30 x G9 x Led (Kg 25)

# Light Bar

*Barre illuminanti nikel e Led con diffusore di policarbonato.*

*Square nikel metal bar with LED lighting and polycarbonate diffuser.*

*Прямоугольный металлический профиль с освещением LED и диффузором из поликарбоната.*



Art. 2226/G  
L 200 x 6 cm H 6cm  
Strip led 17 W/m Tot 68W Lumen 3500  
+ internal power supply to the bar (Kg 10)



Art. 2226/M  
L 150 x 6 cm H 6cm  
Strip led 17 W/m Tot 51W- Lumen2625  
+ internal power supply to the bar (Kg 10)



Art. 2226/P  
L 100 x 6cm H 6 cm  
Strip led 17 W/m Tot 34W Lumen 1750  
+ internal power supply to the bar (Kg 10)

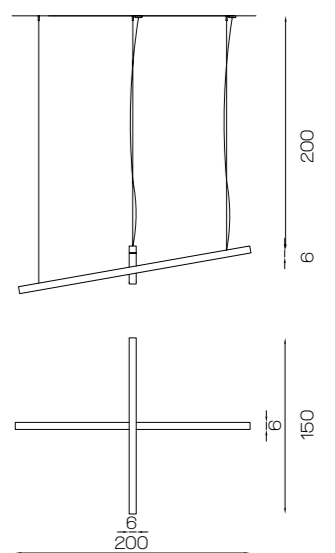

Art. 2226/GM  
L 200 x 150 cm H 6 cm  
Strip led 17 W/m Lumen 6125  
+ internal power supply to the bar (Kg 20)





## *Sticks*

*Ramo illuminante finito in oro pallido spazzolato e diffusore in metacrilato bianco, un design esclusivo uniti all'eccellenza della maestria artigianale coniugano l'amore per il made in Italy.*

*Brushed soft gold metal branch with LED lighting and white metahacrylate diffuser. An exclusive design combined with the excellence of craftsmanship testify the love for Made in Italy.*

*Освещенная ветвь в отделке металла «брашированное светлое золото» с белым метакрилатовым диффузором. Эксклюзивный дизайн в сочетании с высочайшим мастерством объединены любовью к Made in Italy.*



Art. 2231  
L 142 cm x 60 cm H max 100 cm  
Strip led 19 W/m  
(tot 40W-3000 lumen, colour light 3000°k) (Kg 18)

Art. 2231/A  
L 48 cm Sp13 cm H 65 cm  
Strip led 19 W/m  
(tot 15W-1000 lumen, colour light 3000°k) (Kg 10)







Art. 2169/A1  
H 69 cm PØ 12 cm Sp 15 cm  
1 x E14 x Led (Kg 6)



Art. 2169/CH9  
Ø 112 cm H 70 cm PØ 12 cm  
9 x E14 x Led (Kg 20)



Art. 2169/A2  
L 34 cm H 71 cm PØ 12 cm Sp 20 cm  
2 x E14 x Led (Kg 10)





Art. 2169/A2Flex  
L 18 x 9 cm H 39 cm Sp 30 cm  
PØ 12 cm  
1 x E 14 x Led  
1 x Led x 3 watt (Kg 5)

Art. 2169/CH18  
Ø 150 cm H 92 cm  
PØ 12 cm  
18 x E14 x Led (Kg 35)





## *Canebrake*

*Plafoniera e/o applique su base riflettente in acciaio inox con tubi rigati di pirex e finitura brunita.*

*Ceiling or wall lamp on reflective base in stainless steel with striped pyrex tubes and burnished finish.*

*Позиционируемый как плафон или как бра, светильник выполнен из трубок в стекле pyrex с обрuchами в бронзовом металле, зафиксированных на полированной как зеркало отражающей плите из нержавеющей стали.*





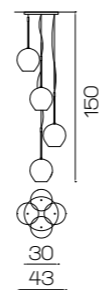

Art. 2241/CH4  
 Ø 43 cm H tot 150 cm  
 4 x G9 x Led (Kg 20)

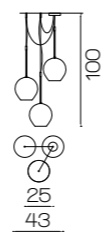

Art. 2241/CH3  
 Ø 43 cm H tot 100 cm  
 3 x G9 x Led (Kg 12)

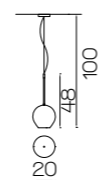

Art. 2241/CH1  
 Ø 20 cm H 48 cm  
 H tot 100 cm  
 1 x G9 x Led (Kg 6)

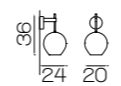

Art. 2241/A  
 Ø 20 cm H 36 cm  
 Sp 24 cm  
 1 x G9 x Led (Kg 2)

## Sbruffo

*Sfera in vetro trasparente e bianca lavorata con la particolare tecnica Muranese "a Sbruffo", ogni pezzo è unico come il gesto del maestro.*

*Transparent and white sphere worked with the particular Muranese "a Sbruffo" technique, each piece is as unique as the master's gesture.*

*Прозрачный с белым шар, выполненный по особой технике муранских мастеров под названием «a Sbruffo».*

*Каждое изделие уникально как жест мастера.*







79

Art. 2174/CH1  
 Ø 22 cm H 53 cm  
 1 x E27 x Led (Kg 6)

Art. 2174/CH2  
 Ø 81 cm H 86 cm  
 2 x E27 x Led (Kg 20)

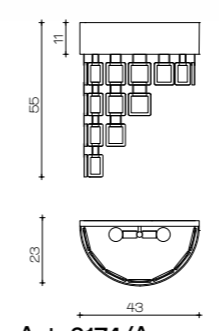

Art. 2174/A  
 L 43 cm H 55 cm Sp 23 cm  
 2 x E14 x Led (Kg 10)



80

IPM light

## Bracelet

*Paralume con bracciali quadrati di vetro di Murano e metallo in colore soft gold.*

*Lampshade with square bracelets in Murano glass and metal in soft gold colour.*

*Абажур с квадратными браслетами из муранского стекла и металла в цвете «светлое золото».*





Art. 2128/A/LUBR  
L 22 cm H 59 cm  
1 x E14 x Led 5 W



Art. 2128/OVLU  
H 62 cm Ø 81 cm  
8 x G9 x Led (Kg 20)





83

Art. 2234  
L 150 x 20 cm H 100 cm  
Led 3000 K 60 W Lumen (Kg 55)



84

Art. 2227/CH12  
Ø 140 cm H 60 cm  
12 x E14 x Led (Kg 25)

IPM light



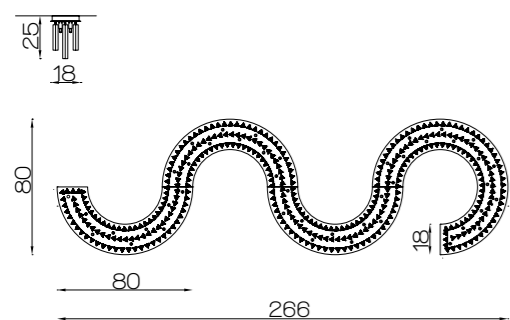

Art. 2254  
L 266 cm x 80 cm H 25 cm  
44 x G9 x Led (140 kg)

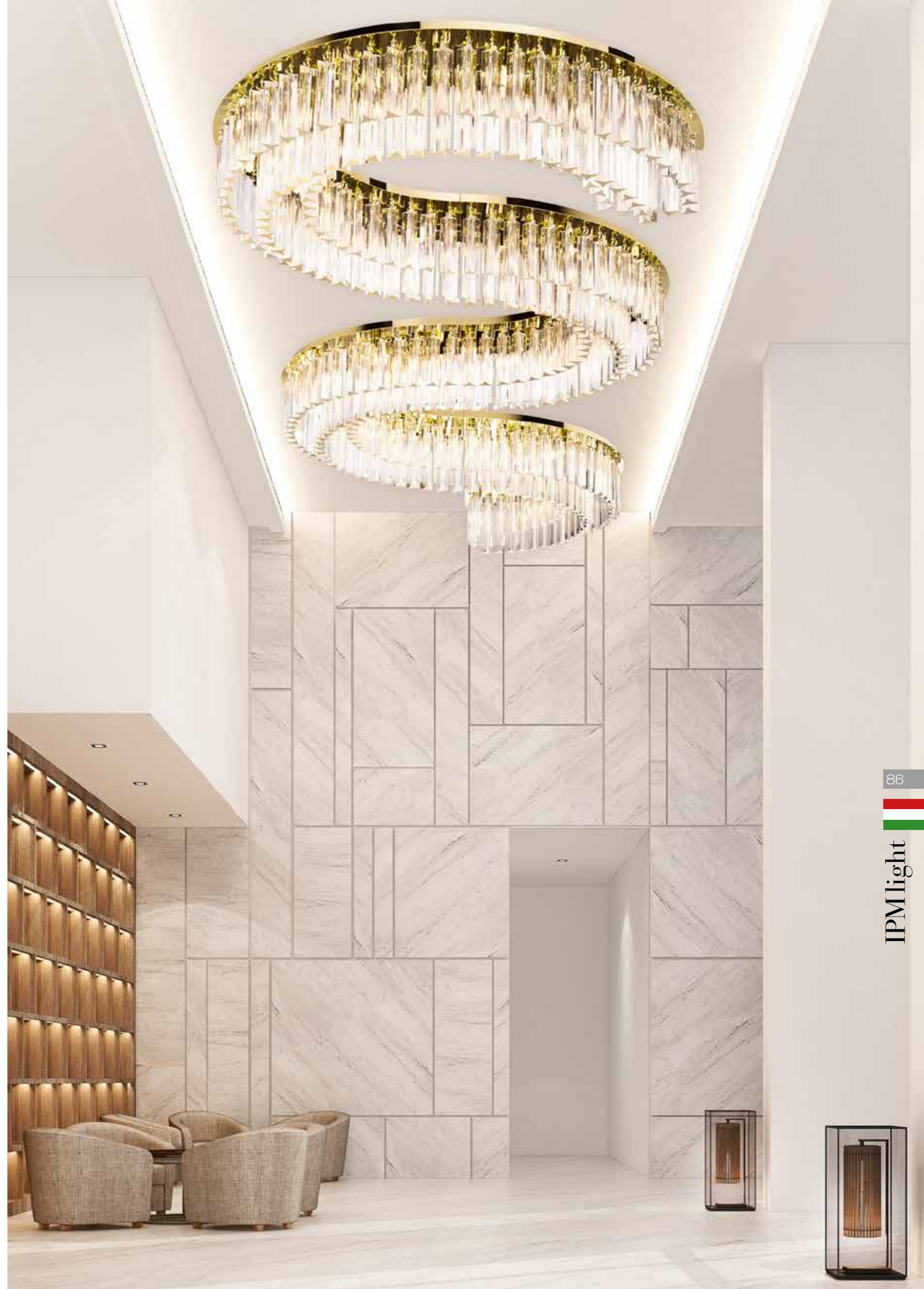



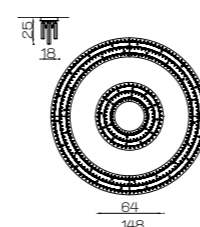

Art. 2255/G  
Ø 148 cm H 25 cm  
54 x G9 x Led (Kg 145)

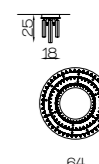

Art. 2255/P  
Ø 64 cm H 25 cm  
18 x G9 x Led (Kg 60)





89

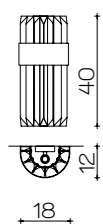

Art. 2252/A  
L 18 Sp 12 cm H 40 cm  
2 x G9 x Led



90



IPMlight

Art. 2252  
L 124 x 40 cm H 40 cm  
16 x G9 x Led (50 kg)





Art. 2215  
 Ø 120 cm  
 H 270 cm  
 48 x E14 x Led (Kg 280)



Art. 2213/CH16  
 L 170 cm H 54 cm  
 H tot 100 cm  
 16 x E14 x Led (Kg 60)

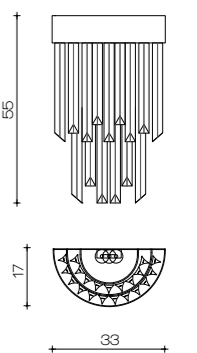

Art. 2213/A  
 L 33 cm Sp 17 cm  
 H 55 cm  
 3 x E14 x Led (Kg 12)





93

Art. 2214  
D 110 cm H 175 cm  
28xE14xled (Kg 250)



94

IPM light

Art. 2210/CH24  
D 106 cm H 56 cm H tot 86cm  
24 x G9 x Led (Kg 30)





Art. 2238  
Ø 100 cm H 55 cm  
14 x E14 x Led (Kg 35)



Art. 2239  
Ø 52 cm H 227 cm  
19 x E27x Led + 1 x E14 x Led (Kg 180)





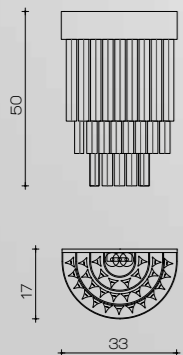

Art. 1971/A/NL  
 L 33 cm Sp 17 cm  
 H 50 cm  
 3 x E14 x Led (Kg 15)



Art. 2242  
 L 40 cm H 18 cm  
 Sp 12 cm  
 2 x G9 x Led





# Vine Leaves

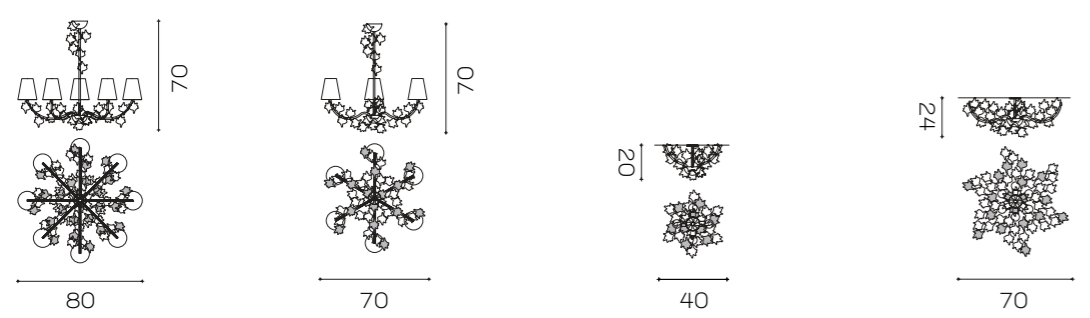

Art. 2171/CH8  
 Ø 80 cm H 70 cm  
 PØ 12 cm  
 8 x E14 x Led (Kg 20)

Art. 2171/CH6  
 Ø 70 cm H 70 cm  
 PØ 12 cm  
 6 x E14 x Led (Kg 15)

Art. 2171/Ceiling/P  
 Ø 40 cm H 20 cm  
 4 x E14 x Led (Kg 6)

Art. 2171/Ceiling/G  
 Ø 70 cm H 24 cm  
 6 x E14 x Led (Kg 10)

Art. 2171/CH12  
 L 156 x 90 cm H 90 cm  
 PØ 15 cm  
 12 x E14 x Led (Kg 25)

Art. 2171/CEILING/M  
 Ø 60 cm H 24 cm  
 6 x E14 x Led (Kg 9)

*Plafoniera con foglie di vite in metallo e vetro trasparente di Murano*  
*Chandelier with VINE LEAVES in metal and Murano Glass, lampshade in organza*  
*Люстра-плафон с коротким крепежом. Букет из виноградных листьев в металле и стекле*





Art. 2171/CH6/AR  
Ø 90 cm H 70 cm  
6 x E14 x Led



Art. 2171/A2/AR  
L 44 cm H 55 cm  
Sp 20 cm PØ 16cm  
2 x E14 x Led



Art. 2171/A3  
L 44 cm H 68 cm  
PØ 12 cm Sp 20 cm  
3 x E14 x Led (Kg 12)





## *Mariateresa Style*

*Lampadario Style Mariateresa con telaio in metallo dorato ricoperto di listelli in vetro e pendagli trasparenti Asfour.*

*Mariateresa style chandelier with gold plated metal frame covered by transparent glass elements and Asfour Crystal pendants.*

*Люстра в стиле Мариятереза выполнена из прозрачного стекла, закрепленного на металлической структуре в цвете золото.*

*Подвески из прозрачного хрусталя Асфур*

Art. 2235/CH45  
Ø 130 cm H 97 cm  
45 x E14 x led (Kg 70)





Art. 2236/CH63  
Ø 165 cm H 200 cm  
63 x E14 x led (Kg 210)





107



108

IPM light

Art. 2250/CH16  
Ø108 cm H 135 cm  
16 x E14 x Led (Kg 80)





Art. 2221/A2  
L 37cm H 43cm  
Sp 17 cm  
2 x E14xLed (Kg 5)



Art. 2221/CH6  
Ø 58 cm H 68 cm  
6 x E14 x Led (Kg 22)





Art. 2246/CH12  
Ø 157 cm H 140 cm  
12 x E14 x Led (Kg 50)





113

Art. 2247/CH6  
Ø 70 cm H 80 cm  
6 x E14 x Led (Kg 20)



114

Art. 2244/CH6  
Ø 82 cm H 100 cm  
6 x E14 x Led (Kg 30)



Art. 2245/CH12  
Ø 120 cm H 86 cm  
12 x E14 x Led (Kg 25)



115



Art. 2245/A3  
L 60 cm Sp 30 cm H 55 cm  
3 x E14 x Led (Kg 4)

Art. 2245/CH21  
Ø 120 cm H 157 cm  
21 x E14 x Led (Kg 45)

116

IPM light





Art. 2237  
Ø 40 cm H 38 cm  
4 x E 27 x Led (Kg 25)



Art. 2228/CH12  
Ø 100 cm H 80 cm  
12 x E14 x Led (Kg 30)



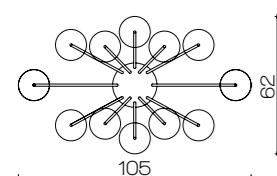

Art. 2251/CH120VAL  
L 105 x 62 cm H 55 cm Pd 14cm  
12 x E14 x Led (20 kg)

Art. 2251/A5  
L 52 cm Sp 31cm H 49 cm Pd 14cm  
5 x E14 x Led (5 Kg)

Art. 2251/CH20  
Ø115 cm H 65 cm  
20 x E14 x Led (35 kg)





121

Art.2223/CEILING  
Ø 136 H 165 cm  
21 x G9x Led



122

Art.2223/FL  
Ø 136 H 165 cm  
21 x G9x Led

IPM light





MADE WITH  
SWAROVSKI  
ELEMENTS

SWAROVSKI® e un marchio registrato



Atelier del Paralume  
Atelier lampshades  
Ателье абажуров



Fusione in Ottone  
Brass casting  
Литье латуни



Vetro di Murano  
Murano glass  
Муранское стекло



Cristallo Italiano  
Italian Crystal  
Итальянский хрусталь

## Il Paralume Marina

La Passione, la dedizione e la cura attentissima del dettaglio, animano l'atelier della Signora Marina. Moderne tecnologie affiancano lavorazioni manuali tradizionali per ottenere un prodotto totalmente esclusivo e di eccellenza, 100% Made in Italy. La continua ricerca e innovazione di tessuti e passamanerie rende Il Paralume Marina Leader nel creare oggetti su misura.

*Passion, dedication and careful attention to detail bring to life the workshop of Mrs. Marina. Modern technologies alongside traditional manual processes obtain a product totally unique and of high quality, 100% Made in Italy. The continuous research and innovation of fabrics and trimmings makes Il Paralume Marina, the Leader in creating custom-made products.*

В ателье госпожи Марины царят Вдохновение, Страсть, Самоотдача и высочайшее Внимание к деталям. Современные технологии идут рука об руку с традиционными техниками рукоделия, воплощаясь в эксклюзивном продукте, 100% сделанном в Италии. Постоянные исследования и применения последних инноваций в тканях и окантовках делают Il Paralume Marina лидером среди производителей персонализированных изделий.

La fusione in terra dell'ottone è un'arte antica, che ancora oggi sa emozionare. La pressofusione crea oggetti di eccellenza e di altissima qualità sinonimi di lusso ed eleganza esclusivamente made in Italy. Fondiamo metallo trasformando l'idea di architetti e designer in oggetti esclusivi, dal prototipo allo stampo, al prodotto finito.

*Brass sand casting is an ancient art, which still continues to excite. Casting creates objects of excellence and of the highest quality, demonstrating luxury and elegance exclusively made in Italy. We base metal transformation on the ideas of exclusive product architects and designers, from the prototype, to the mould, to the finished product.*

Литье латуни «в землю» - это античное искусство, которое и сегодня способно вызывать эмоции. Литье создает предметы высокого качества с особым благородным шармом, присущим роскошным интерьерам, сделанным исключительно в Италии. Мы плавим металл, трансформируя идею архитектора и дизайнера в эксклюзивные предметы: от прототипа - к штампу - до законченного продукта

Maestri artigiani che tramandano l'arte antica muranese garantiscono un prodotto di classe di alta gamma e qualità indiscutibili. La produzione interamente artigianale e l'uso di tecniche raffinate rendono ogni oggetto un pezzo unico. L'esperienza dei maestri per noi è un punto di partenza per creare oggetti attuali di arredamento e di emozione. La forza del Paralume Marina è la qualità eccellente e la flessibilità nell'assecondare le richieste di un mercato internazionale sempre in evoluzione.

*Master craftsmen who hand down the ancient art of Murano guarantee a high-class product of unquestionable quality. Total handmade production and the use of sophisticated techniques make each product unique. The experience of the master craftsmen is a starting point for us to create real pieces of furniture of emotion. The strength of Il Paralume Marina is the excellent quality and flexibility to adapt to the demands of an ever changing market.*

Мастера-ремесленники передают античное искусство муранского стекла из поколения в поколение, что гарантирует их изделиям высочайший уровень качества. Изготовление вручную и использование искусственных техник делают каждое их творение уникальным и неповторимым. Опыт Мастеров является для нас отправной точкой для создания актуальных предметов интерьера с ярким эмоциональным оттенком. Сильной стороной Il Paralume Marina является безупречное качество и гибкость в подходе к требованиям динамичного и такого разнообразного международного рынка.

Il cristallo è orgogliosamente solo italiano. Si ottiene fondendo in appositi forni a temperatura elevata, superiore a 1400°, utilizzando materie prime di qualità superiore si ottiene un prodotto con oltre il 24% di PbO, che conferisce una luminosità e trasparenza indiscutibili. La lavorazione del cristallo è eseguita artigianalmente; viene soffiato a bocca e le incisioni sono eseguite interamente a mano per cui ogni oggetto diviene "Objet d'Arte".

*Paralume Marina proudly uses only Italian crystal. It is made by melting in special high temperature furnaces, exceeding 1400°, using optimum quality raw materials a product is obtained with over 24% of PbO, which gives an undeniable brightness and clarity. The processing of crystal is carried out by hand; it is blown and the incisions are made entirely by hand so that every object becomes an "Objet d'art".*

Исключительно лучший итальянский хрусталь является нашей гордостью и отличительной чертой. Его получают посредством плавки в специальных печах при высокой температуре, превышающей 1400°, используя материалы лучшего качества. Это позволяет получить продукт с процентом свинца в составе в 24% и выше, что придает изделиям безупречную прозрачность и яркость. Обработка хрусталя проходит вручную: его выдувают, а затем гравировать полностью вручную, что гарантирует каждому изделию титул Произведения Искусства.



## Project

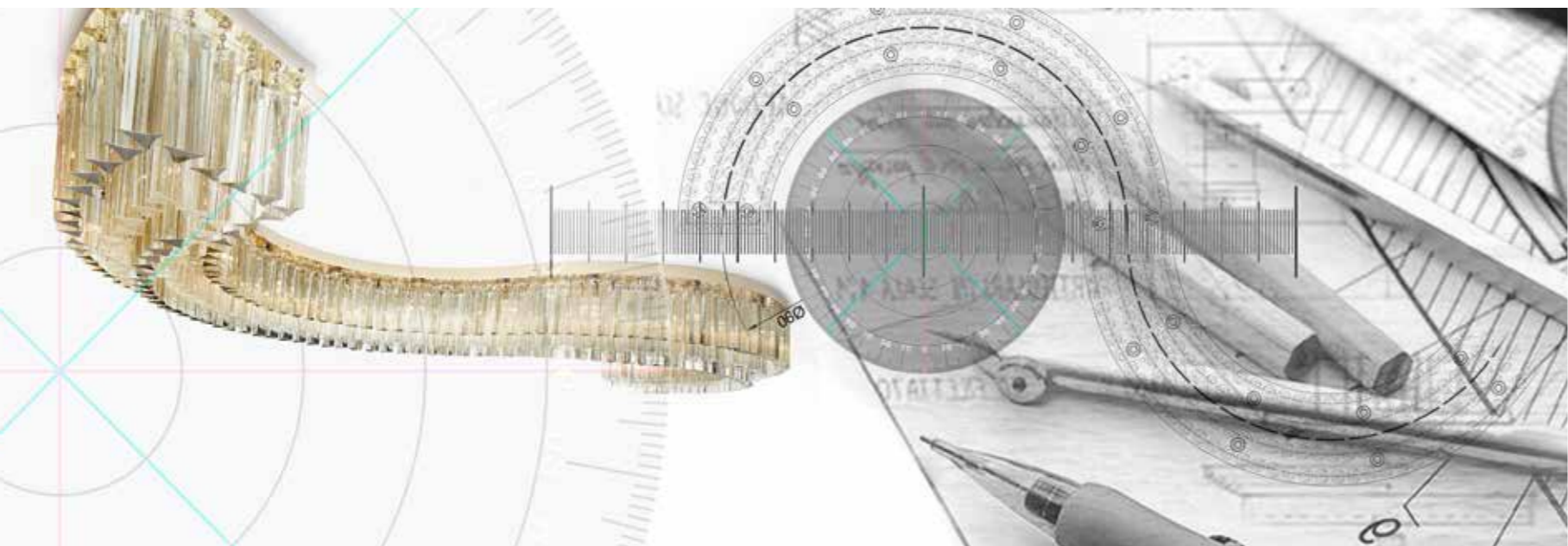

Ogni progetto è una sfida che affrontiamo con serietà e passione, dedizione al cliente e cura nei dettagli maniacale.

Il Paralume Marina con la sua esperienza e con il suo team interno di designer e ingegneri, garantisce un servizio esclusivo ai professionisti che desiderano utilizzare soluzioni di illuminazione decorativa nei loro progetti, proponendo alternative stilistiche, tecniche ed economiche adeguate alla richieste della committenza.

*Each project is a challenge that we approach with seriousness and passion, dedication to the customer and meticulous attention to detail. Il Paralume Marina with its experience and in-house team of designers and engineers, guarantees an exclusive service for users who wish to use decorative lighting solutions in their projects, offering stylistic, technical and inexpensive options adapted to the demand of the client.*

Каждый проект – это вызов, который мы принимаем с максимальной серьезностью и страстью, преданностью клиенту и маниакальным вниманием к деталям. Il Paralume Marina со своим опытом и собственной сплоченной командой дизайнеров и инженеров, гарантирует эксклюзивный сервис для профессионалов, которые желают включить в собственные проекты смелые решения по декоративному освещению, предлагая стилистические, технические и экономические альтернативы, оптимально адаптированные под запрос Заказчика.

# Il Paralume Marina

Contemporary Lighting

Design: Arch. Federica Vicentini  
Proget Director: Thomas Simoncello  
Printing: Girardi Print Factory

Tutte le misure sono indicate in cm  
H = altezza, L = larghezza,  
Ø = diametro, PØ = diametro del paralume,  
Sp = sporgenza.

Tutti i diritti riservati.  
Sono vietate la pubblicazione la trasmissione la fotocopiatura e qualsiasi altra forma di duplicazione o riproduzione, parziali e totali dei testi e della grafica qui contenuti, senza il preventivo consenso scritto della ditta il Paralume Marina. Il produttore si riserva il diritto di introdurre modifiche tecnologiche. Il produttore declina qualsiasi responsabilità per eventuali errori di stampa.

Il Paralume Marina s.r.l.  
Vicolo Col Beretta, 6  
36022 San Zeno di Cassola (VI) ITALY

Tel +39 0424 33 042  
Fax +39 0424 511 817

www.ilparalumemarina.com  
info@ilparalumemarina.it  
Skype: ilparalumemarina

*Made in Italy*

Since 1987