

# SAVOY HOUSE ESSENTIALS

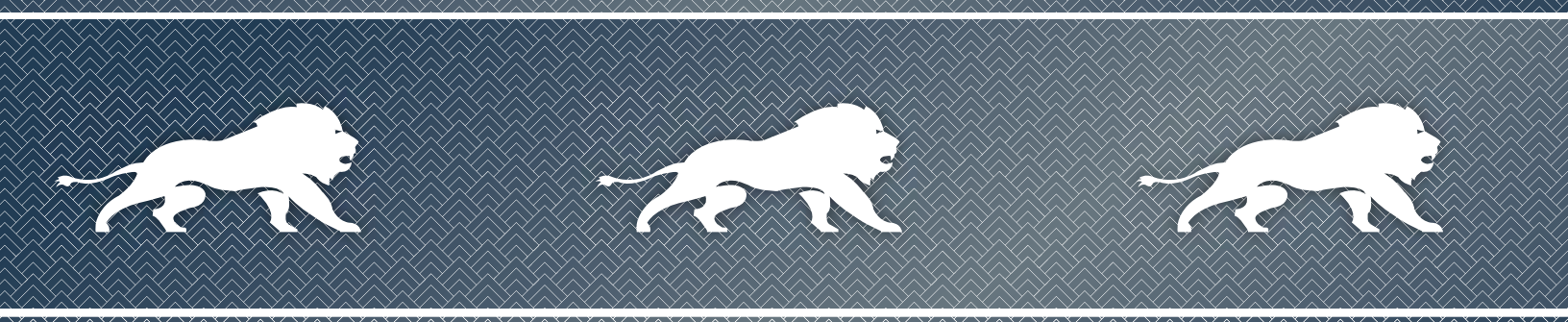

JANUARY 2020





# Savoy House COLLECTIONS...

The Savoy House Essentials Collection was created with modern American home décor style in mind. Blurring the design boundaries of classic and transitional, modern and contemporary, these fixtures are designed to effortlessly mix and match so you can create a refined style that is indicative of the modern American look. Each piece is crafted and thoughtfully chosen to work well on its own or together for a complimentary companion look. Available in up to five finishes, including our most popular matte black, these fixtures are perfect for today's open-concept home designs. Designed with the same high quality and attention to detail that you have come to expect from Savoy House, customers can choose with confidence when they choose to purchase from the Savoy House Essentials Collection.



# CONTENTS

ALPHABETICAL LISTING *by* FAMILY:

Abbott .....	12	Hayden.....	8
Aberdeen.....	144	Kent .....	108
Akron .....	104	Lacey.....	141
Alden.....	116	Lilly .....	96
Ashmont .....	120	Lucerne.....	146
Austin.....	118	Magnum.....	102
Avalon.....	134	Marly .....	86
Avery .....	4	Marshall.....	174
Bally.....	133	Mayfield.....	129
Berg.....	122	Melrose.....	194
Bergamo.....	16	Merrill .....	166
Braxton .....	94	Middleton .....	38
Calhoun .....	184	Monroe.....	154
Cameron .....	70, 162, 188	Morland .....	168
Capra.....	190	Octave.....	74, 131, 138, 176
Carson .....	172	Payton.....	160
Chaplin.....	159	Pendleton.....	124
Chatham.....	66	Penrose.....	112
Clifton .....	165	Pike.....	164
Dakota .....	170	Prescott.....	26
Darlington .....	192	Rotterdam .....	34
Dash.....	106	Rutland.....	150
Delaney .....	198	Shane .....	126
Denton .....	62	Sherrill.....	140
Destin.....	158	Stirling .....	101
Drake.....	130, 171, 180	Townsend.....	48
Dumont .....	88	Vale .....	186
Dunbar .....	80	Walpole .....	136
Epsilon.....	100	Washburn.....	163
Everett.....	28, 32	Watkins .....	142
Franklin.....	132	Waverly.....	152
Galea .....	84	Westbourne.....	98
Garrett.....	110	William.....	90
Carvey .....	128		



# CONTENTS



Collections ..... 4



Flush Mounts / Semi-Flush ..... 134



Wall Lighting ..... 150



Pour Le Bain / Bath ..... 172

*Index / Finish Guide* ..... 200

# AVERY

---

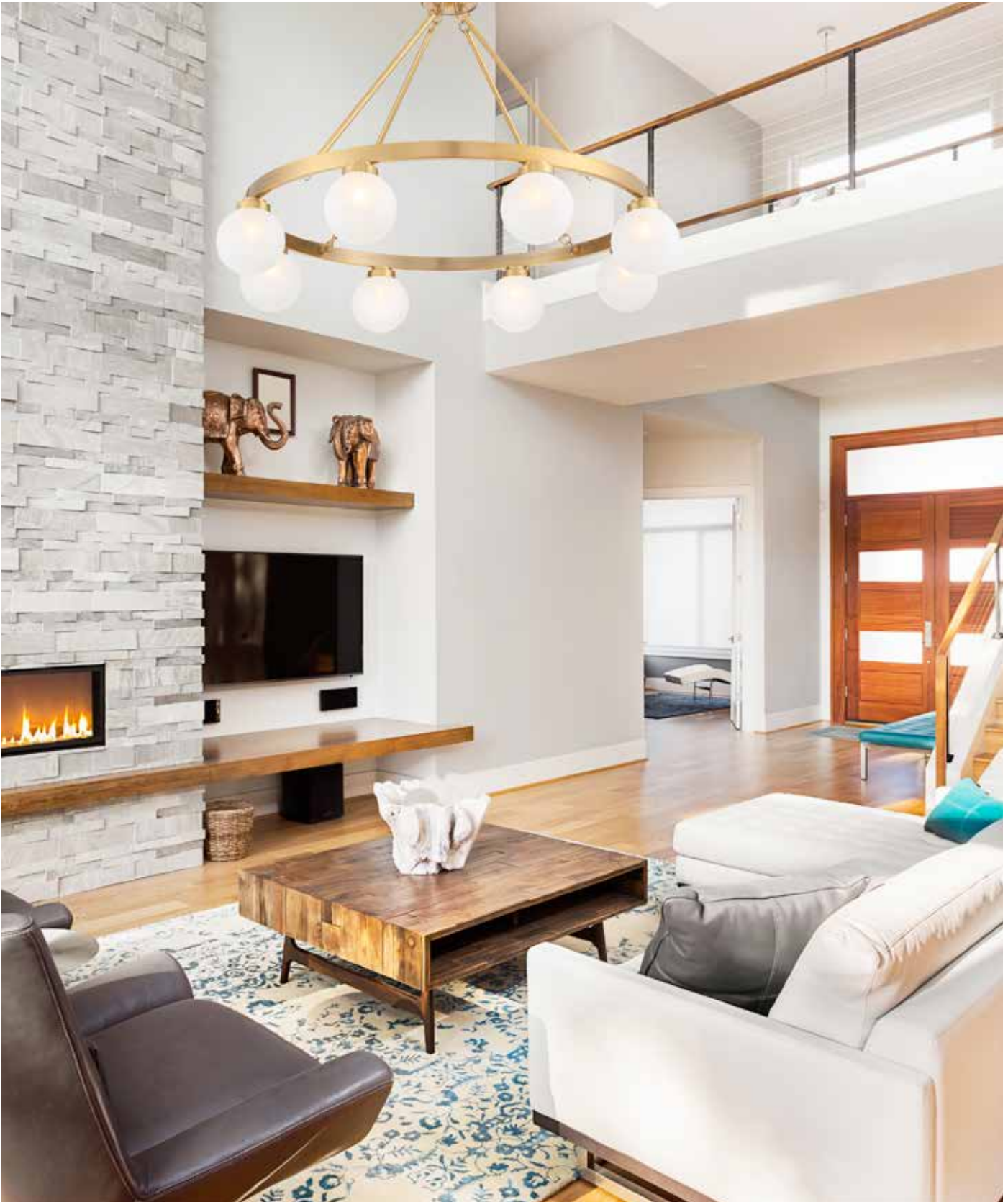



**BRIAN THOMAS**  
COLLECTION

A.



B.



**A. 1-1841-8-322**  
8-Light Chandelier  
Warm Brass Finish  
34"W x 26-1/2"H  
8C9 40W  
Frosted Glass  
*C9 Bulbs Included*

**B. 1-1841-8-SN**  
8-Light Chandelier  
Satin Nickel Finish  
34"W x 26-1/2"H  
8C9 40W  
Frosted Glass  
*C9 Bulbs Included*

# AVERY

---



**BRIAN THOMAS**  
COLLECTION

A.



- A. **1-1840-6-322**  
6-Light Chandelier  
Warm Brass Finish  
28"W x 25-5/8"H  
6C9 40W  
Frosted Glass  
*G9 Bulbs Included*

B.

- B. **1-1840-6-SN**  
6-Light Chandelier  
Satin Nickel Finish  
28"W x 25-5/8"H  
6C9 40W  
Frosted Glass  
*G9 Bulbs Included*







# HAYDEN

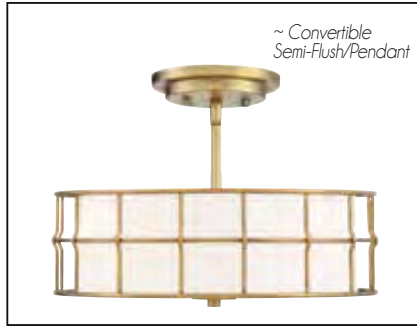

\*A.



\*\*B.



\*\*C.

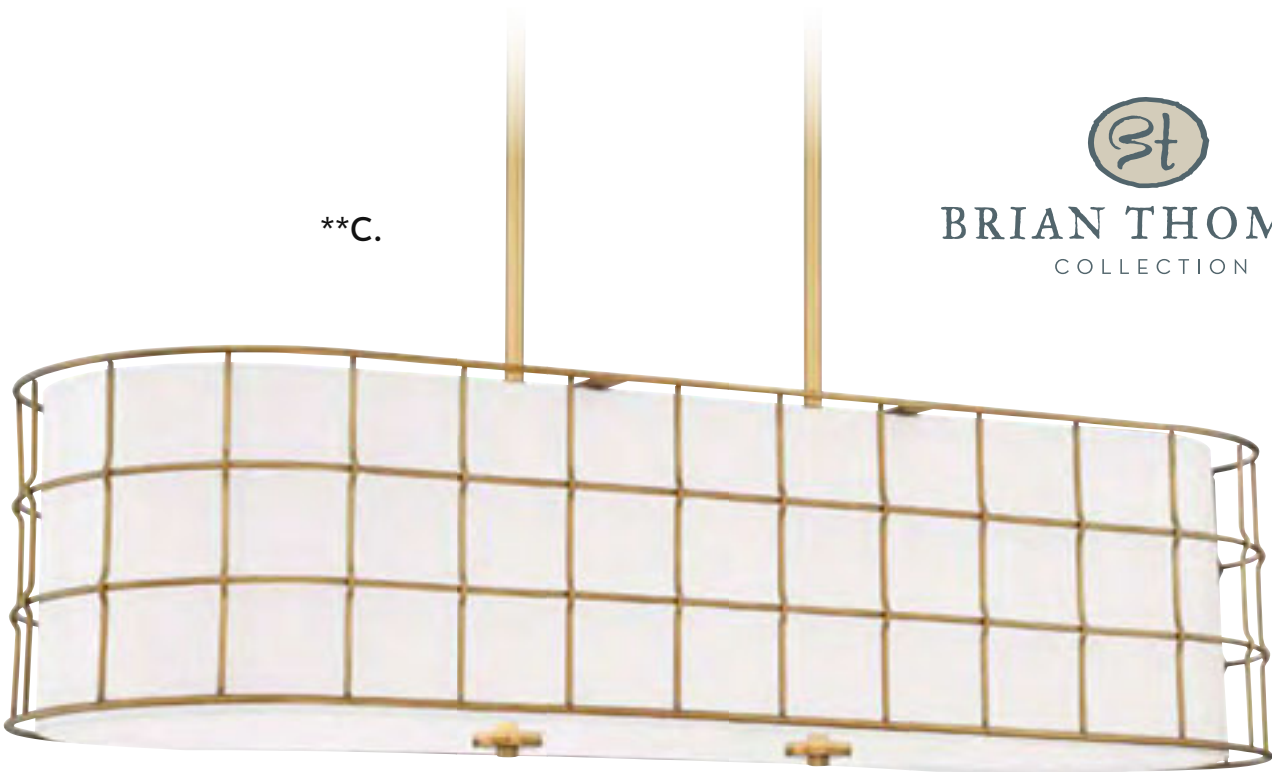

**BRIAN THOMAS**  
COLLECTION

\*Options: 7-EXT-322 Extension Rod - 9-1/2"

\*\*Options: 7-EXTLG-322 Extension Rod - 12"



**A. 6-8502-3-322**  
3-Light Convertible  
Semi-Flush/Pendant  
Warm Brass Finish  
15"W x 5-1/4"H  
Adj H 5-1/4" - 59-1/4"  
3E 60W  
30° Swivel  
White Fabric Shade

**B. 7-8501-5-322**  
5-Light Pendant  
Warm Brass Finish  
25"W x 10-1/4"H  
Adj H 10-1/4" - 64-1/4"  
5E 60W  
30° Swivel  
White Fabric Shade

**C. 1-8500-5-322**  
5-Light Linear Chandelier  
Warm Brass Finish  
42"L x 13-1/2"W x 10-1/4"H  
Adj H 10-1/4" - 64-1/4"  
5E 60W  
30° Swivel  
White Fabric Shade

# HAYDEN



**A. 7-8501-5-89**  
5-Light Pendant  
Matte Black Finish  
25"W x 10-1/4"H  
Adj H 10-1/4" - 64-1/4"  
5E 60W  
30° Swivel  
White Fabric Shade

**B. 6-8502-3-89**  
3-Light Convertible  
Semi-Flush/Pendant  
Matte Black Finish  
15"W x 5-1/4"H  
Adj H 5-1/4" - 59-1/4"  
3E 60W  
30° Swivel  
White Fabric Shade

**C. 1-8500-5-89**  
5-Light Linear Chandelier  
Matte Black Finish  
42"L x 13-1/2"W x 10-1/4"H  
Adj H 10-1/4" - 64-1/4"  
5E 60W  
30° Swivel  
White Fabric Shade

# HAYDEN



\*B.



  
BRIAN THOMAS  
COLLECTION

\*\*C.



\*Options: 7-EXT-BK Extension Rod - 9-1/2"

\*\*Options: 7-EXTLG-BK Extension Rod - 12"

# ABBOTT

A. **7-8401-4-89**  
4-Light Pendant  
Matte Black Finish  
21-3/4"W x 8"H  
Adj H 8" - 128"  
4E 60W  
White Fabric Shade

B. **1-8400-8-89**  
8-Light Linear Chandelier  
Matte Black Finish  
44"L x 14-3/4"W x 9"H  
Adj H 9" - 129"  
8E 60W  
White Fabric Shade



A.



B.

# ABBOTT



# ABBOTT

---





# ABBOTT

A.



**A. 7-8401-4-SN**  
4-Light Pendant  
Satin Nickel Finish  
21-3/4"W x 8"H  
Adj H 8" - 128"  
4E 60W  
White Fabric Shade

**B. 1-8400-8-SN**  
8-Light Linear Chandelier  
Satin Nickel Finish  
44"L x 14-3/4"W x 9"H  
Adj H 9" - 129"  
8E 60W  
White Fabric Shade

B.



# BERGAMO

---



A.

A. 7-2852-6-154  
6-Light Pendant  
Antique Nickel Finish  
26"W x 23-1/2"H  
6C 60W  
Clear Crystal

B. 7-2852-6-322  
6-Light Pendant  
Warm Brass Finish  
26"W x 23-1/2"H  
6C 60W  
Clear Crystal



B.

# BERGAMO



# BERGAMO

---



# BERGAMO

A. 7-2851-4-322  
4-Light Pendant  
Warm Brass Finish  
19-7/8"W x 32-1/4"H  
4C 60W  
Clear Crystal

B. 7-2851-4-154  
4-Light Pendant  
Antique Nickel Finish  
19-7/8"W x 32-1/4"H  
4C 60W  
Clear Crystal

A.

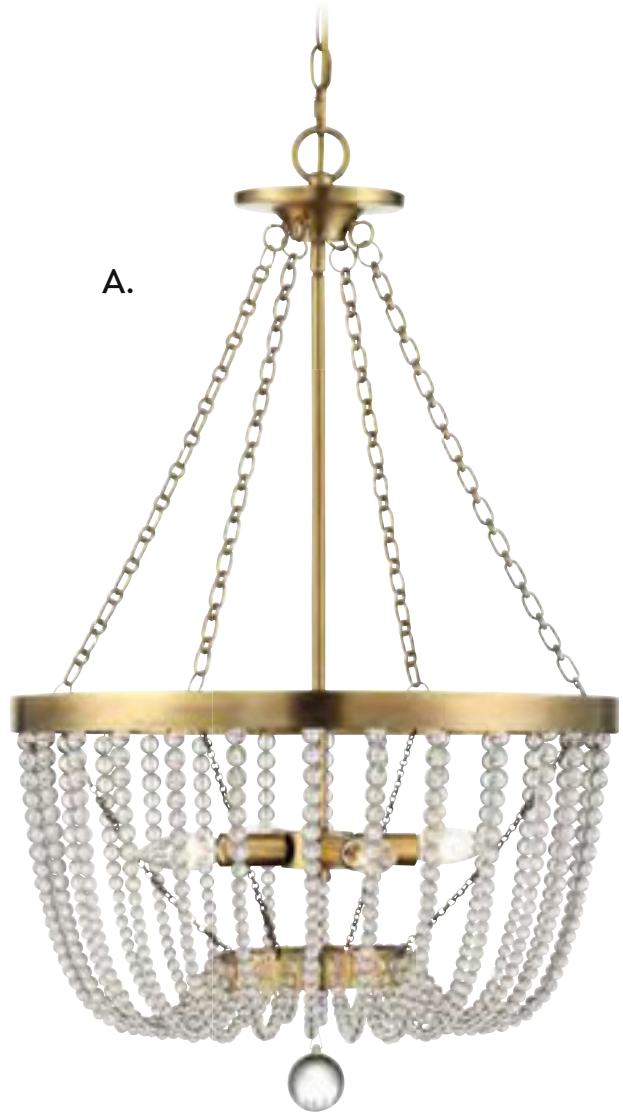

B.

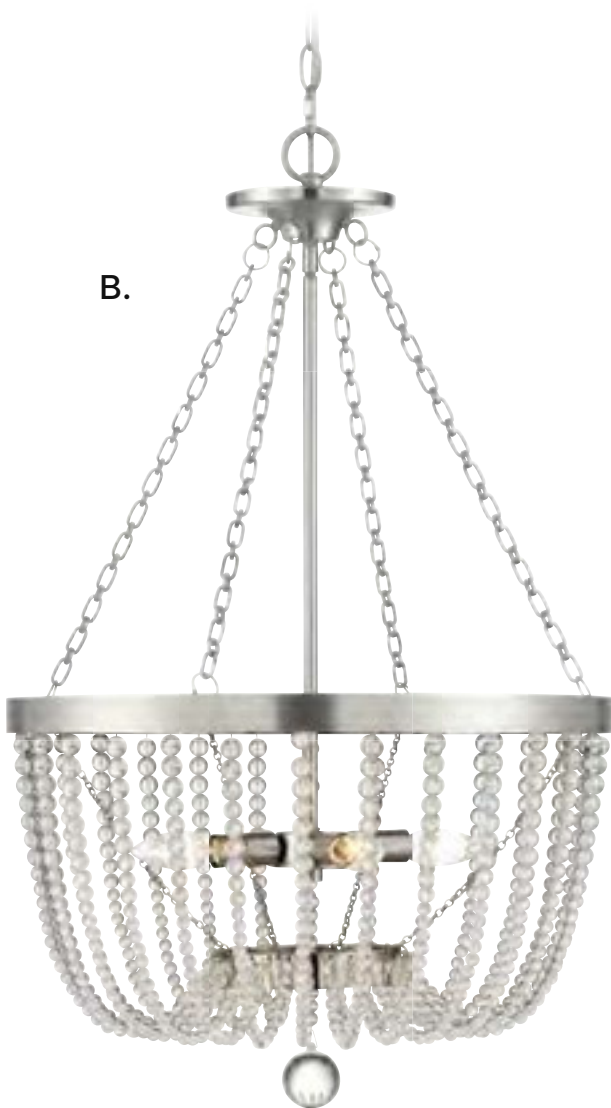

# WINDHAM



- A. 7-8701-6-109**  
6-Light Pendant  
Polished Nickel Finish  
28"W x 28"H  
6C 60W  
Clear Crystal
- B. 7-8700-4-109**  
4-Light Pendant  
Polished Nickel Finish  
20"W x 22"H  
4C 60W  
Clear Crystal
- C. 1-8702-8-109**  
8-Light Linear Chandelier  
Polished Nickel Finish  
38"L x 16"W x 26"H  
8C 60W  
Clear Crystal

# WINDHAM

A.



B.



C.



# WINDHAM



- A. 7-8701-6-322**  
6-Light Pendant  
Warm Brass Finish  
28"W x 28"H  
6C 60W  
Clear Crystal
- B. 7-8700-4-322**  
4-Light Pendant  
Warm Brass Finish  
20"W x 22"H  
4C 60W  
Clear Crystal
- C. 1-8702-8-322**  
8-Light Linear Chandelier  
Warm Brass Finish  
38"L x 16"W x 26"H  
8C 60W  
Clear Crystal



# WINDHAM

A.



B.



C.



# WINDHAM

---

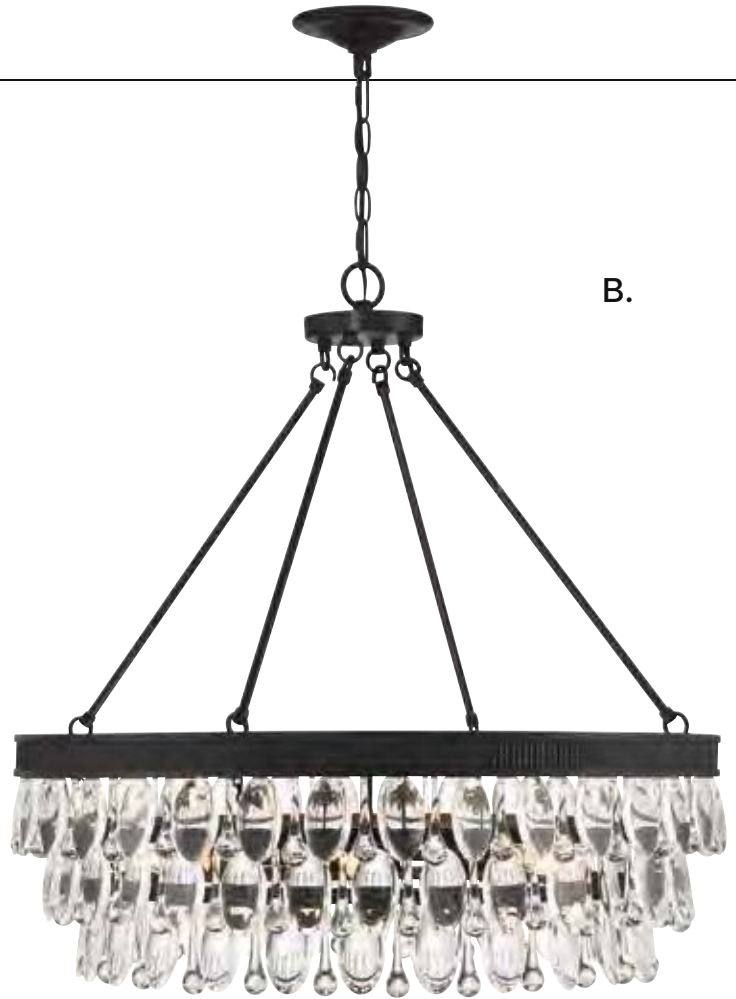
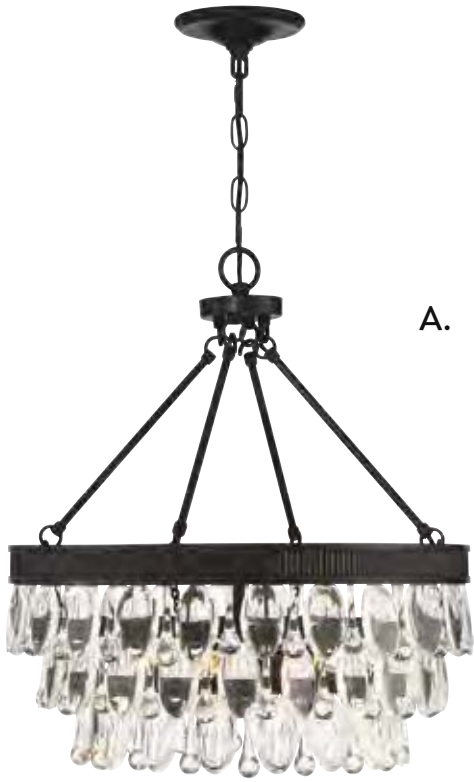

# WINDHAM



- A. 7-8700-4-13**  
4-Light Pendant  
English Bronze Finish  
20"W x 22"H  
4C 60W  
Clear Crystal
- B. 7-8701-6-13**  
6-Light Pendant  
English Bronze Finish  
28"W x 28"H  
6C 60W  
Clear Crystal
- C. 1-8702-8-13**  
8-Light Linear Chandelier  
English Bronze Finish  
38"L x 16"W x 26"H  
8C 60W  
Clear Crystal

# PRESCOTT



**A.**



**B.**

**A. 9-0601-1-SN**

1-Light Sconce  
Satin Nickel Finish  
6-1/2"W x 12-1/4"H  
x 4-3/4"E  
1E 60W  
Clear Beveled Glass  
Metal Candle Cover

**B. 9-0601-1-322**

1-Light Sconce  
Warm Brass Finish  
6-1/2"W x 12-1/4"H  
x 4-3/4"E  
1E 60W  
Clear Beveled Glass  
Metal Candle Cover

**C. 1-0602-6-SN**

6-Light Linear  
Chandelier  
Satin Nickel Finish  
36"L x 8"W x 21"H  
6E 60W  
Clear Beveled Glass  
Metal Candle Covers

**D. 7-0600-6-SN**

6-Light Pendant  
Satin Nickel Finish  
28"W x 28"H  
6C 60W  
Clear Beveled Glass  
Metal Candle Covers

**E. 1-0602-6-322**

6-Light Linear  
Chandelier  
Warm Brass Finish  
36"L x 8"W x 21"H  
6E 60W  
Clear Beveled Glass  
Metal Candle Covers

**F. 7-0600-6-322**

6-Light Pendant  
Warm Brass Finish  
28"W x 28"H  
6C 60W  
Clear Beveled Glass  
Metal Candle Covers

# PRESCOTT

C.



D.



E.

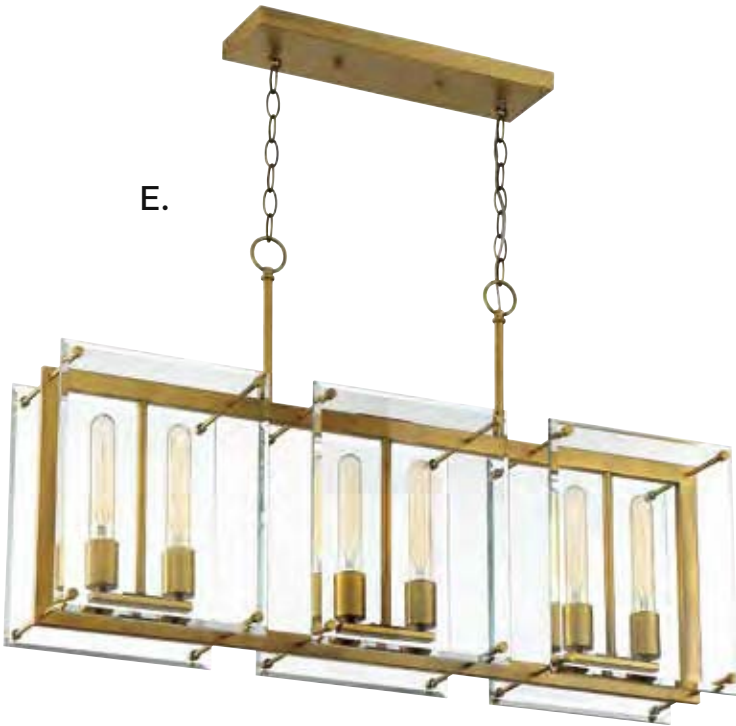

F.



# EVERETT

---

\*A.



\*B.

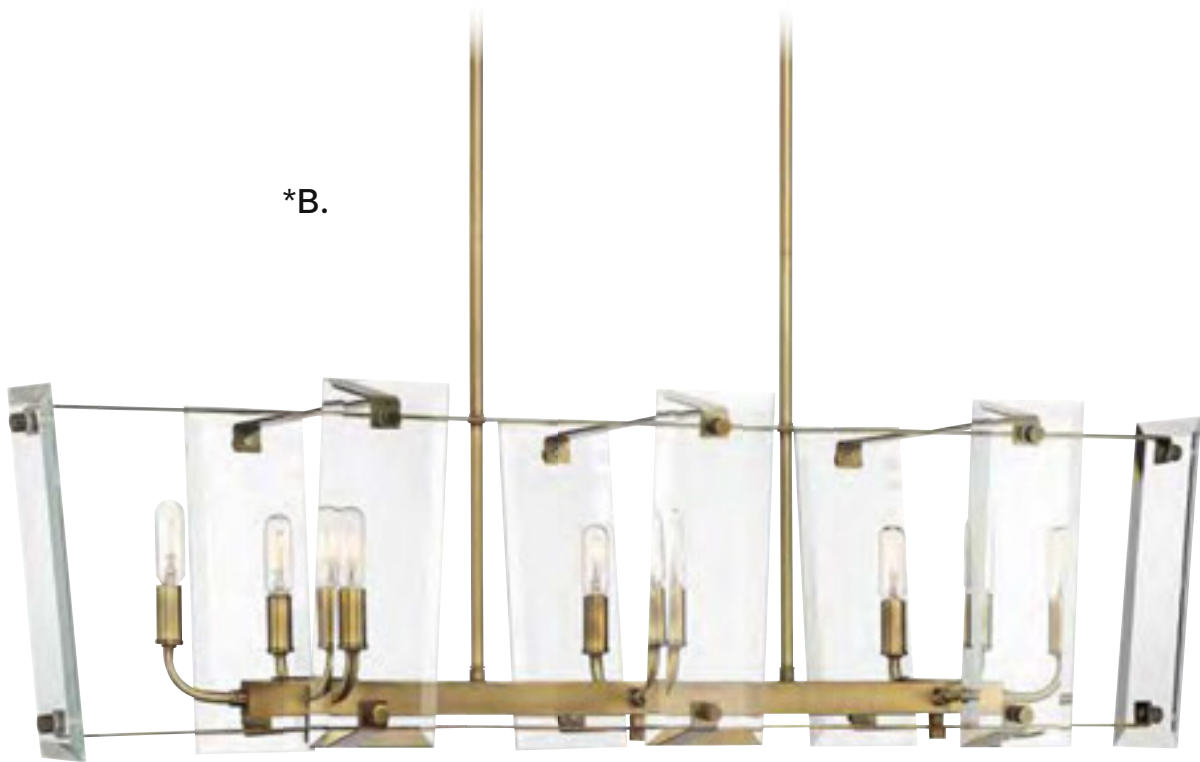

\*Options: 7-EXT- Extension Rod - 9-1/2"

# EVERETT



**A. 1-7113-8-SN**  
8-Light Linear Chandelier  
Satin Nickel Finish  
44"L x 14"W x 11"H  
Adj H 11"- 68"  
8C 60W  
30° Swivel  
Clear Beveled Glass  
Metal Candle Covers

**B. 1-7113-8-322**  
8-Light Linear Chandelier  
Warm Brass Finish  
44"L x 14"W x 11"H  
Adj H 11"- 68"  
8C 60W  
30° Swivel  
Clear Beveled Glass  
Metal Candle Covers

**C. 1-7113-8-89**  
8-Light Linear Chandelier  
Matte Black Finish  
44"L x 14"W x 11"H  
Adj H 11"- 68"  
8C 60W  
30° Swivel  
Clear Beveled Glass  
Metal Candle Covers



\*C.

\*Options: 7-EXT- Extension Rod - 9-1/2"

# EVERETT

A.



*\*Convertible:  
Semi-Flush/Pendant*



B.



*\*Convertible:  
Semi-Flush/Pendant*



C.



*\*Convertible:  
Semi-Flush/Pendant*

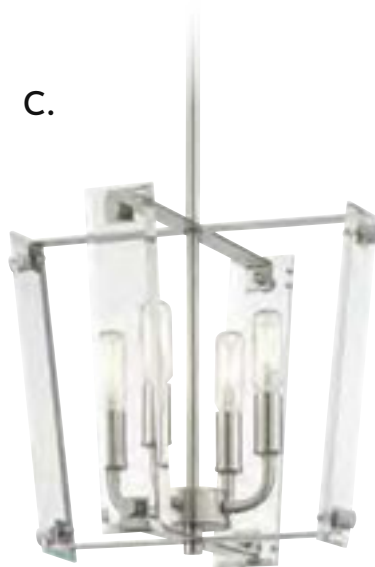

- A. 6-7110-4-322**  
 4-Light Convertible Semi-Flush/Pendant  
 Warm Brass Finish  
 13"W x 11"H  
 Adj H 11" - 68"  
 4C 60W  
 30° Swivel  
 Clear Beveled Glass  
 Metal Candle Covers
- B. 6-7110-4-89**  
 4-Light Convertible Semi-Flush/Pendant  
 Matte Black Finish  
 13"W x 11"H  
 Adj H 11" - 68"  
 4C 60W  
 30° Swivel  
 Clear Beveled Glass  
 Metal Candle Covers
- C. 6-7110-4-SN**  
 4-Light Convertible Semi-Flush/Pendant  
 Satin Nickel Finish  
 13"W x 11"H  
 Adj H 11" - 68"  
 4C 60W  
 30° Swivel  
 Clear Beveled Glass  
 Metal Candle Covers

Options: 7-EXT- Extension Rod - 9-1/2"



# EVERETT

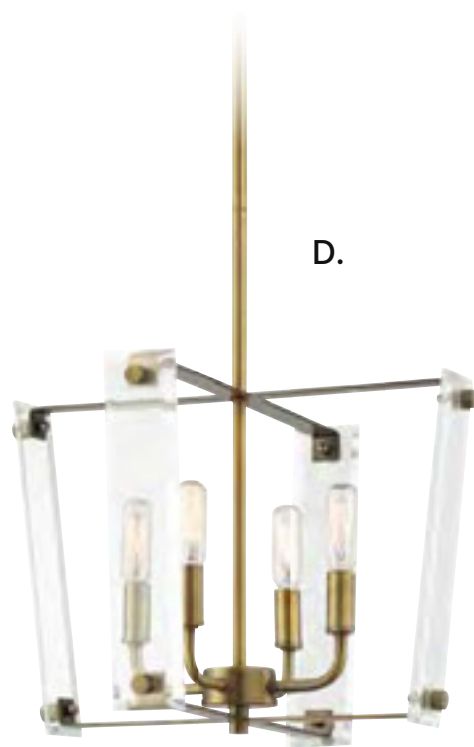

D.

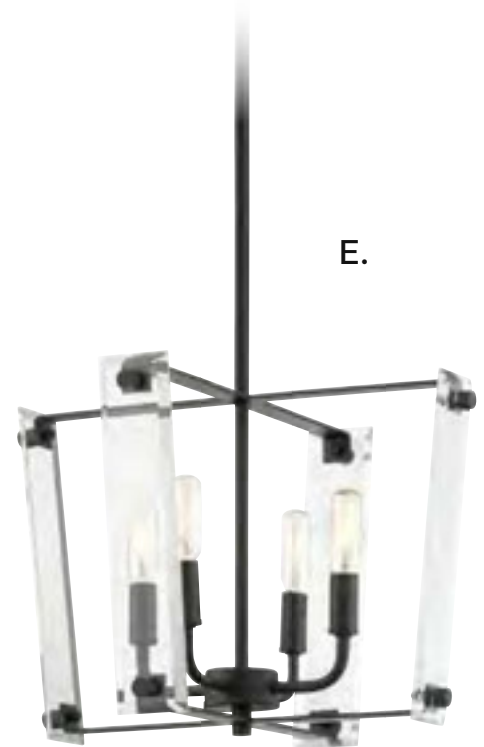

E.

- D. **7-7111-4-322**  
4-Light Pendant  
Warm Brass Finish  
16"W x 11"H  
Adj H 11"- 68"  
4C 60W  
30° Swivel  
Clear Beveled Glass  
Metal Candle Covers

- E. **7-7111-4-89**  
4-Light Pendant  
Matte Black Finish  
16"W x 11"H  
Adj H 11"- 68"  
4C 60W  
30° Swivel  
Clear Beveled Glass  
Metal Candle Covers

- F. **7-7111-4-SN**  
4-Light Pendant  
Satin Nickel Finish  
16"W x 11"H  
Adj H 11"- 68"  
4C 60W  
30° Swivel  
Clear Beveled Glass  
Metal Candle Covers

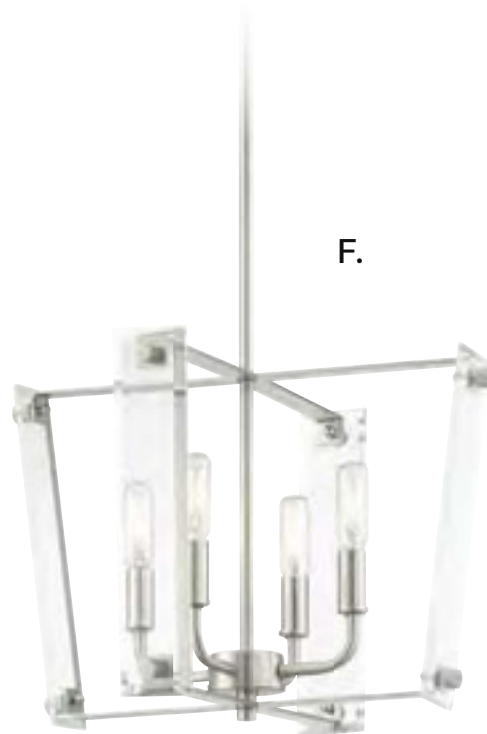

F.

Options: 7-EXT- Extension Rod - 9-1/2"

# EVERETT



# EVERETT

A.



B.



C.



**A. 3-7112-3-322**  
3-Light Pendant  
Warm Brass Finish  
13"W x 16"H  
Adj H 16"- 73"  
3C 60W  
30° Swivel  
Clear Beveled Glass  
Metal Candle Covers

**B. 3-7112-3-89**  
3-Light Pendant  
Matte Black Finish  
13"W x 16"H  
Adj H 16"- 73"  
3C 60W  
30° Swivel  
Clear Beveled Glass  
Metal Candle Covers

**C. 3-7112-3-SN**  
3-Light Pendant  
Satin Nickel Finish  
13"W x 16"H  
Adj H 16"- 73"  
3C 60W  
30° Swivel  
Clear Beveled Glass  
Metal Candle Covers

Options: 7-EXT- Extension Rod - 9-1/2"

# ROTTERDAM



**A. 7-1660-6-322**

6-Light Pendant  
Warm Brass Finish  
31-1/2"L x 24-3/4"W x 20-1/2"H  
Adj H 20-1/2" - 77-1/2"  
6C 60W  
30° Swivel  
Optic Acrylic  
Metal Candle Covers

**B. 6-1662-4-109**

4-Light Convertible  
Semi-Flush/Pendant  
Polished Nickel Finish  
20"W x 18"H  
Adj H 18" - 75"  
4C 60W  
30° Swivel  
Optic Acrylic  
Metal Candle Covers

**C. 6-1662-4-322**

4-Light Convertible  
Semi-Flush/Pendant  
Warm Brass Finish  
20"W x 18"H  
Adj H 18" - 75"  
4C 60W  
30° Swivel  
Optic Acrylic  
Metal Candle Covers

**D. 7-1660-6-109**

6-Light Pendant  
Polished Nickel Finish  
31-1/2"L x 24-3/4"W x 20-1/2"H  
Adj H 20-1/2" - 77-1/2"  
6C 60W  
30° Swivel  
Optic Acrylic  
Metal Candle Covers

# ROTTERDAM

A.

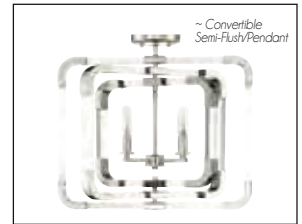
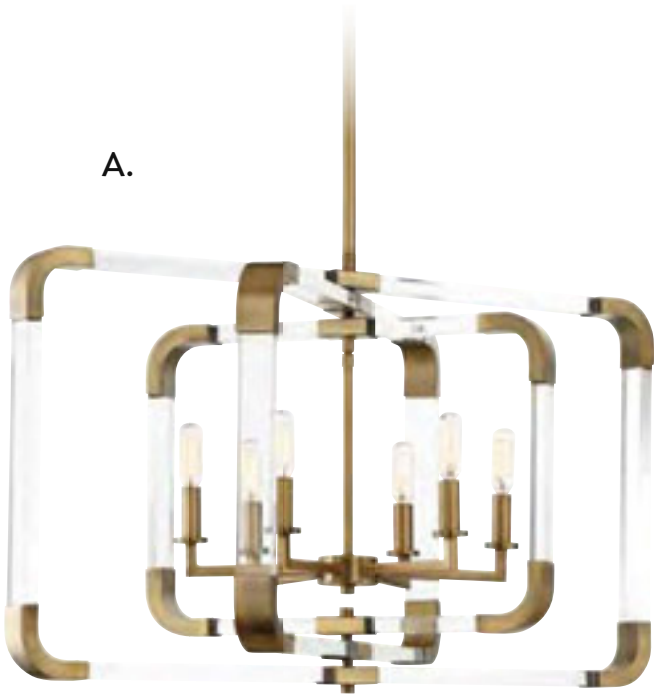

B.



BRIAN THOMAS  
COLLECTION

C.

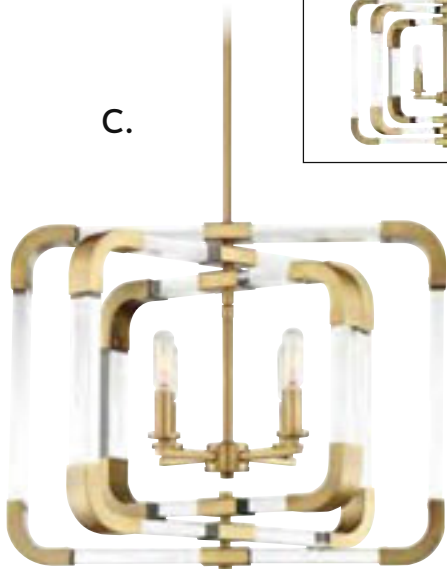
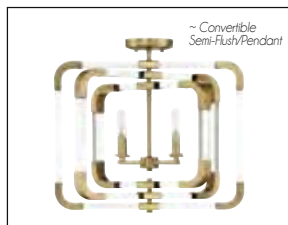

D.

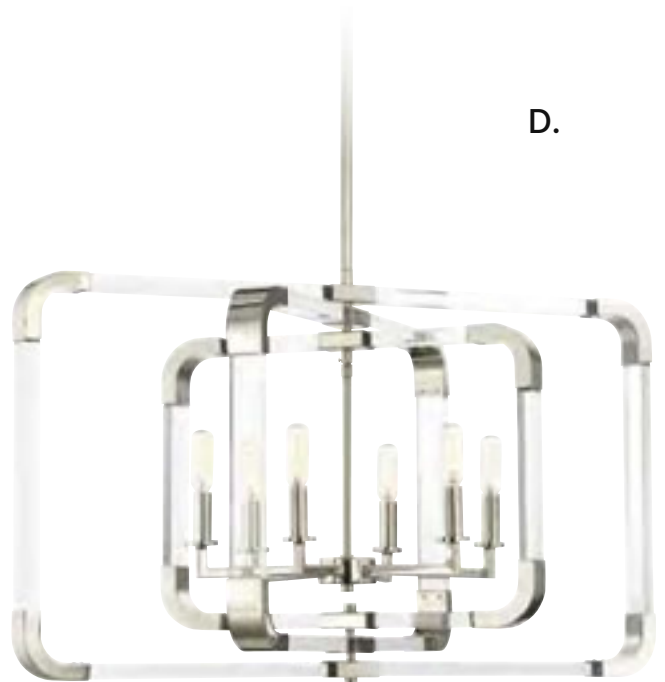

\*\*\*The rings of the Rotterdam Collection are adjustable and can rotate into different positions.

# ROTTERDAM



# ROTTERDAM



BRIAN THOMAS  
COLLECTION

A.

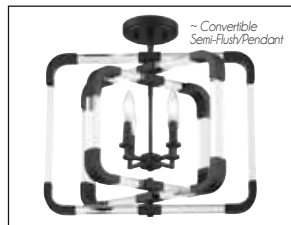
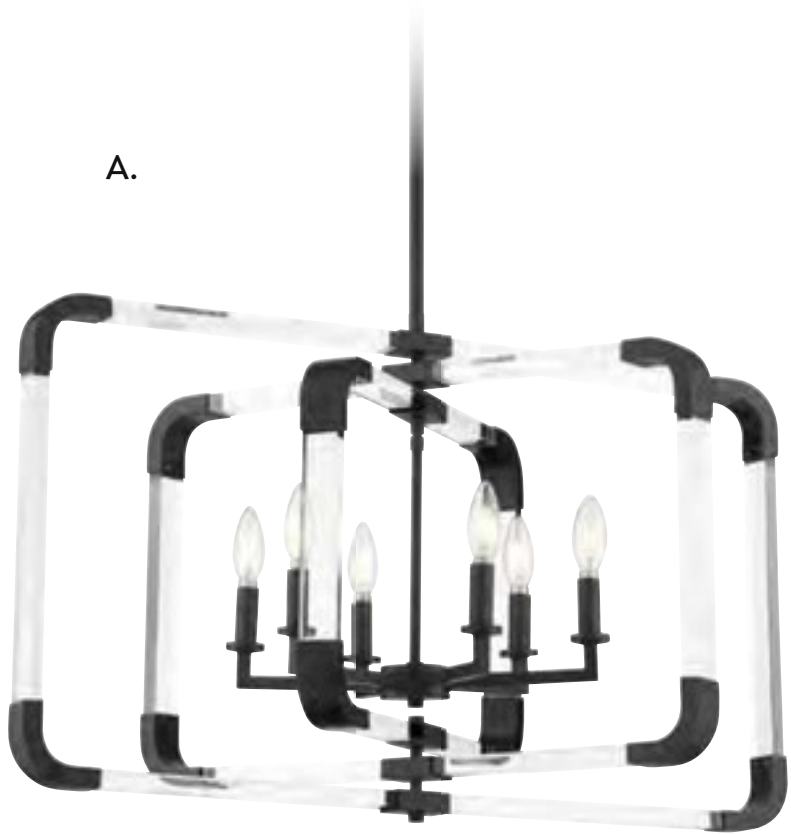

B.

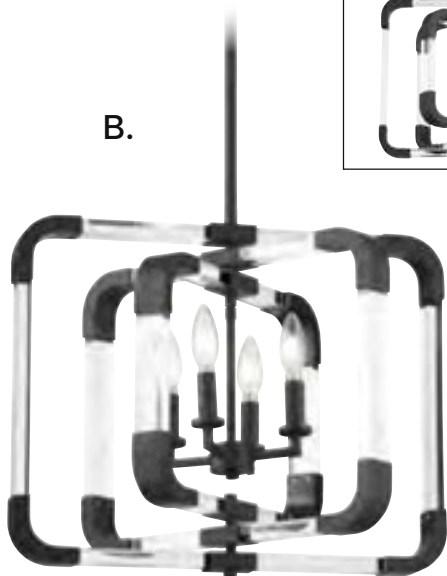

**A. 7-1660-6-89**  
6-Light Pendant  
Matte Black Finish  
31-1/2"L x 24-3/4"W x 20-1/2"H  
Adj H 20-1/2" - 77-1/2"  
6C 60W  
30° Swivel  
Optic Acrylic  
Metal Candle Covers

**B. 6-1662-4-89**  
4-Light Convertible  
Semi-Flush/Pendant  
Matte Black Finish  
20"W x 18"H  
Adj H 18" - 75"  
4C 60W  
30° Swivel  
Optic Acrylic  
Metal Candle Covers

\*\*\*The rings of the Rotterdam Collection are adjustable and can rotate into different positions.

# MIDDLETON



**A. 1-307-6-89**

6-Light Chandelier  
Matte Black Finish  
25"W x 23"H  
6C 60W  
Metal Candle Covers

**B. 1-307-6-109**

6-Light Chandelier  
Polished Nickel Finish  
25"W x 23"H  
6C 60W  
Metal Candle Covers

**C. 1-307-6-322**

6-Light Chandelier  
Warm Brass Finish  
25"W x 23"H  
6C 60W  
Metal Candle Covers

**D. 1-307-6-SN**

6-Light Chandelier  
Satin Nickel Finish  
25"W x 23"H  
6C 60W  
Metal Candle Covers

**E. 1-307-6-44**

6-Light Chandelier  
Classic Bronze Finish  
25"W x 23"H  
6C 60W  
Metal Candle Covers



# MIDDLETON

A.

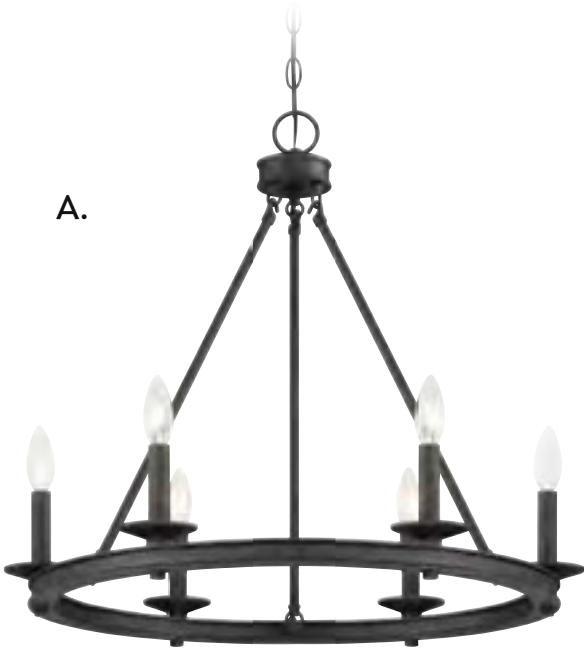

B.

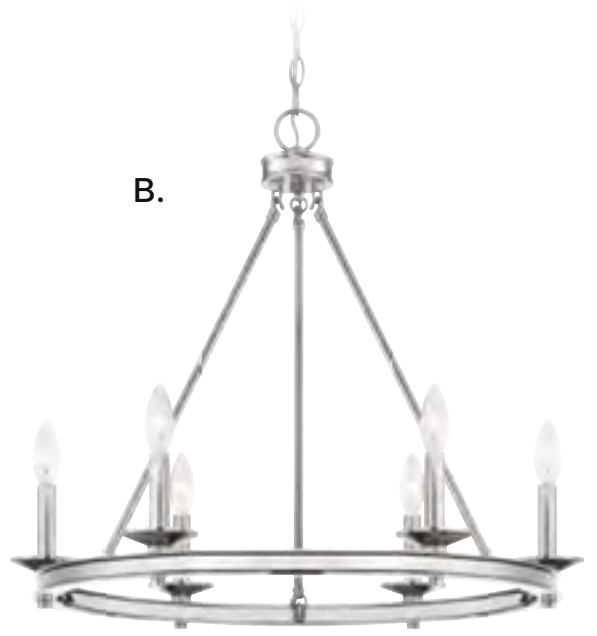

C.

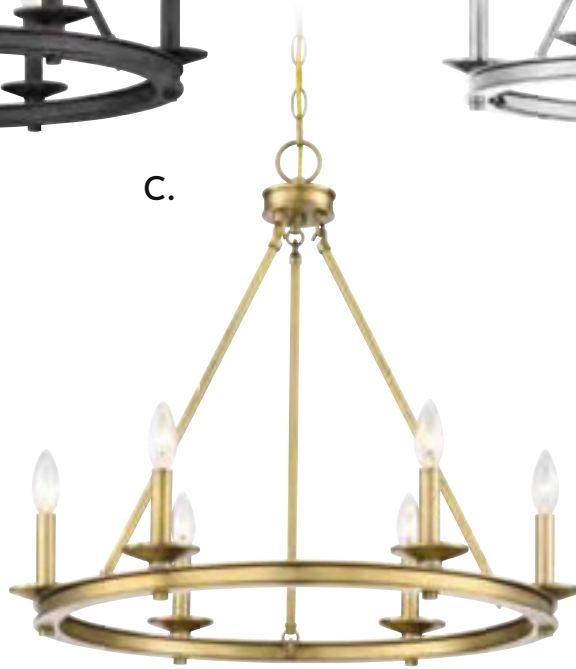

D.

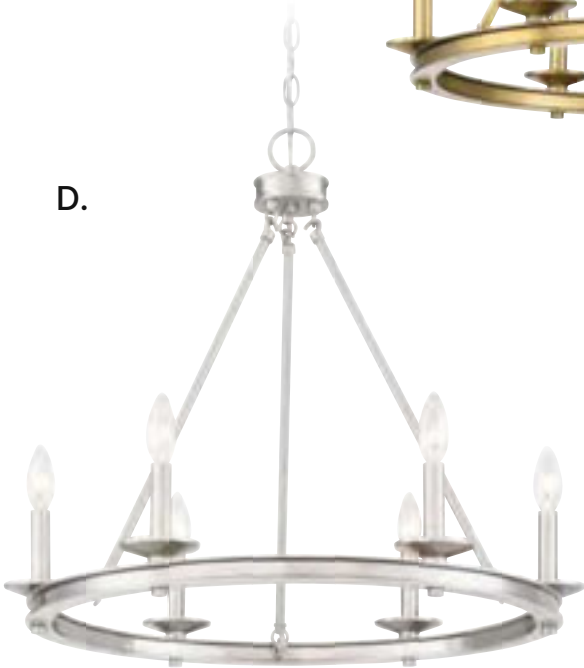

E.

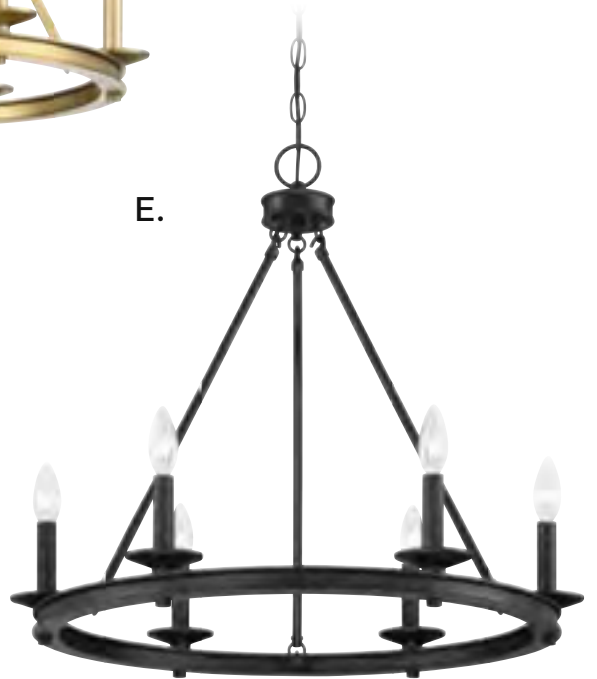

# MIDDLETON

---

A.

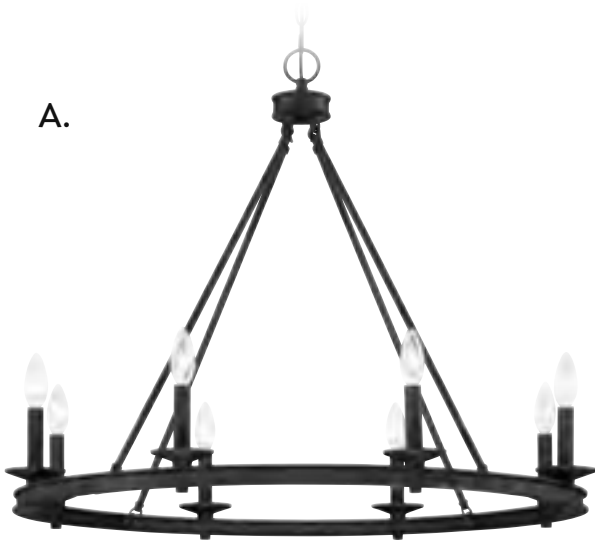

B.

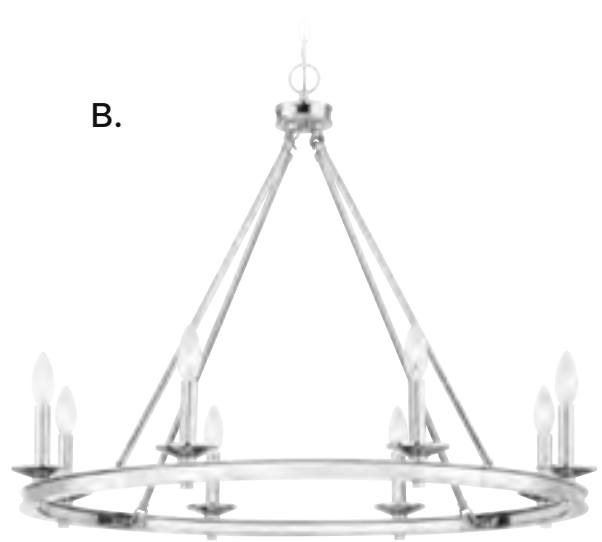

C.

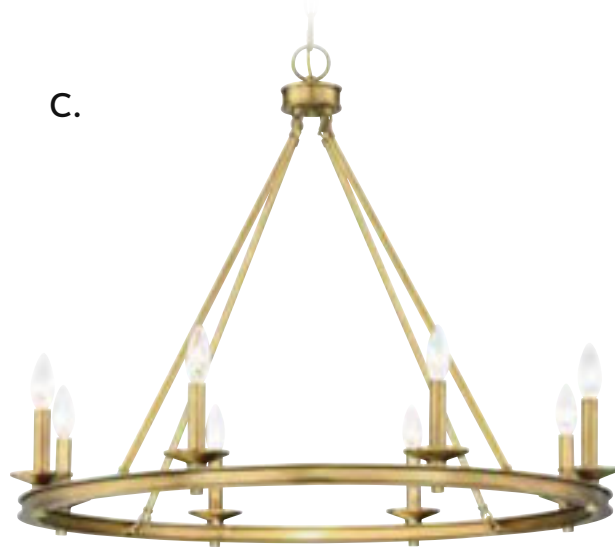

D.

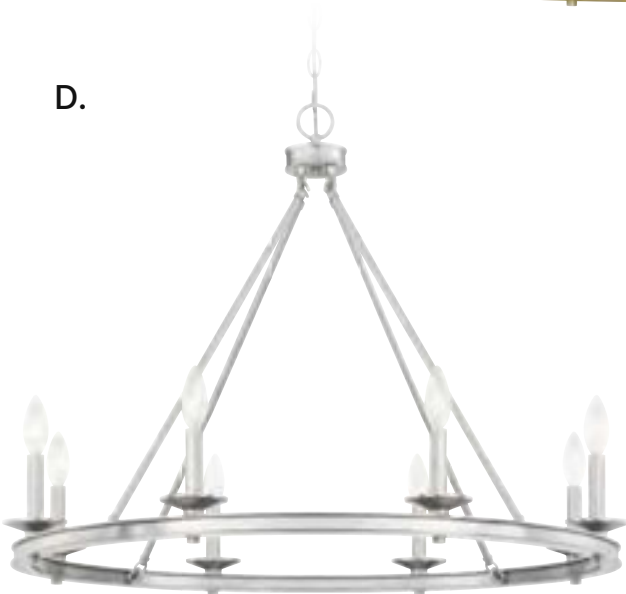

E.

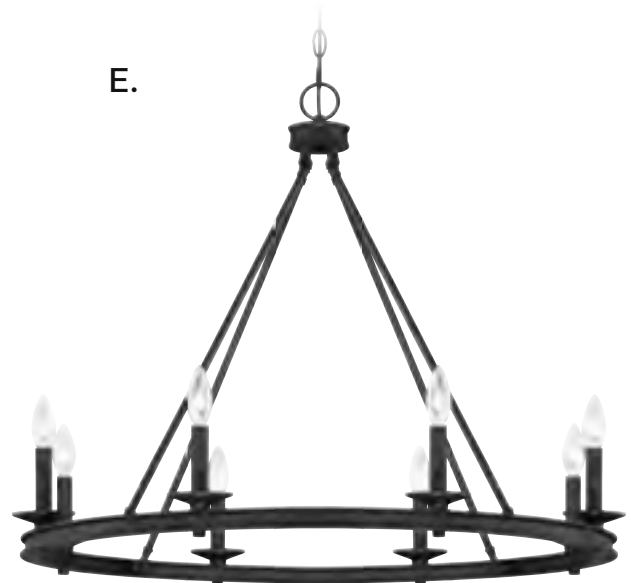

# MIDDLETON



**A. 1-308-8-89**  
8-Light Chandelier  
Matte Black Finish  
33"W x 25"H  
8C 60W  
Metal Candle Covers

**B. 1-308-8-109**  
8-Light Chandelier  
Polished Nickel Finish  
33"W x 25"H  
8C 60W  
Metal Candle Covers

**C. 1-308-8-322**  
8-Light Chandelier  
Warm Brass Finish  
33"W x 25"H  
8C 60W  
Metal Candle Covers

**D. 1-308-8-SN**  
8-Light Chandelier  
Satin Nickel Finish  
33"W x 25"H  
8C 60W  
Metal Candle Covers

**E. 1-308-8-44**  
8-Light Chandelier  
Classic Bronze Finish  
33"W x 25"H  
8C 60W  
Metal Candle Covers

# MIDDLETON

A.

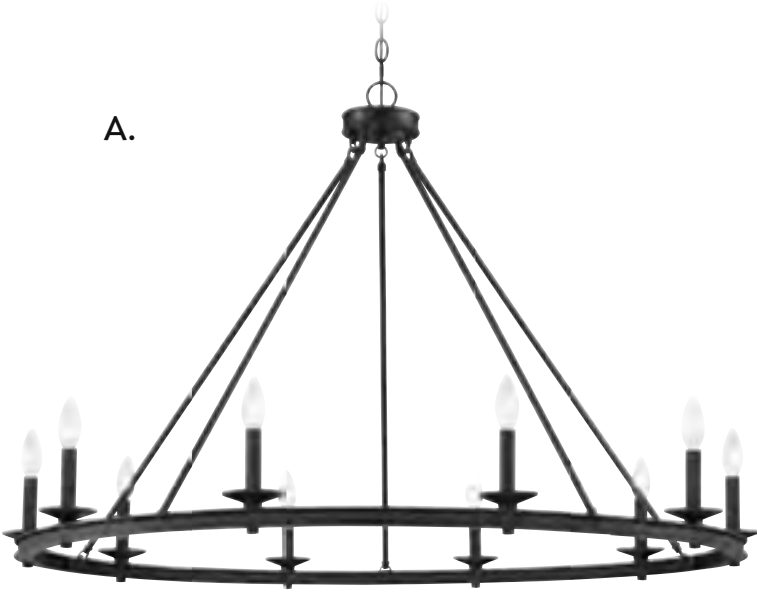

B.

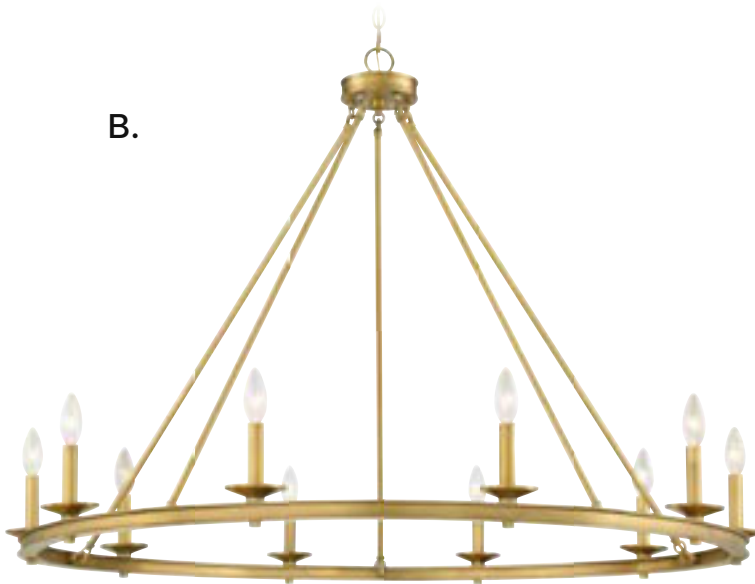

C.

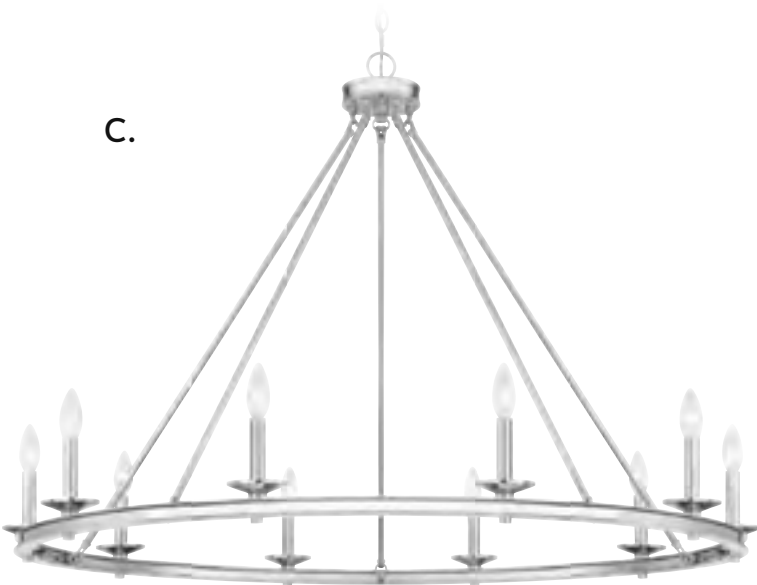

# MIDDLETON

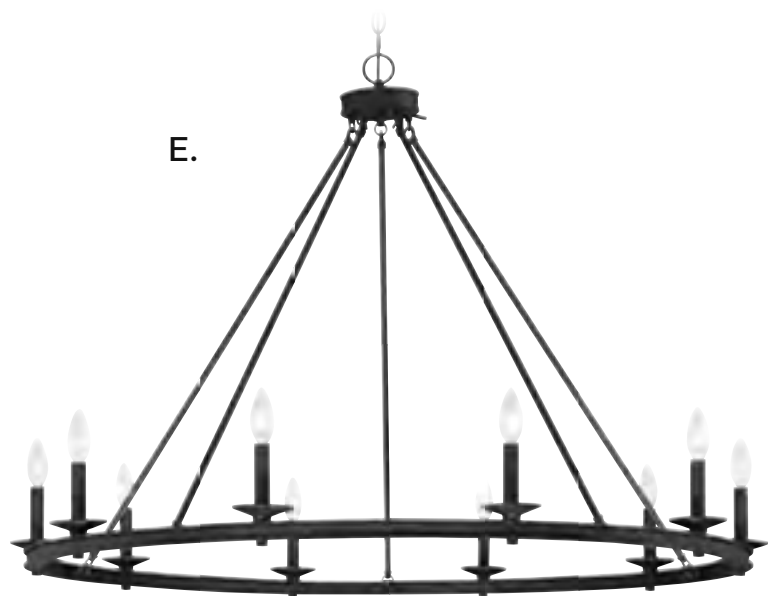
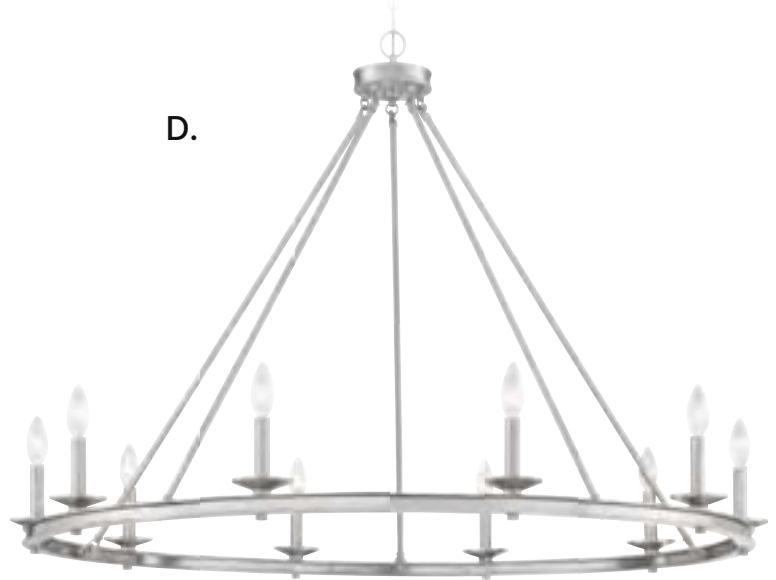

**A. 1-310-10-89**  
10-Light Chandelier  
Matte Black Finish  
45"W x 32-1/4"H  
10C 60W  
Metal Candle Covers

**B. 1-310-10-322**  
10-Light Chandelier  
Warm Brass Finish  
45"W x 32-1/4"H  
10C 60W  
Metal Candle Covers

**C. 1-310-10-109**  
10-Light Chandelier  
Polished Nickel Finish  
45"W x 32-1/4"H  
10C 60W  
Metal Candle Covers

**D. 1-310-10-SN**  
10-Light Chandelier  
Satin Nickel Finish  
45"W x 32-1/4"H  
10C 60W  
Metal Candle Covers

**E. 1-310-10-44**  
10-Light Chandelier  
Classic Bronze Finish  
45"W x 32-1/4"H  
10C 60W  
Metal Candle Covers

# MIDDLETON

---



# MIDDLETON

A.

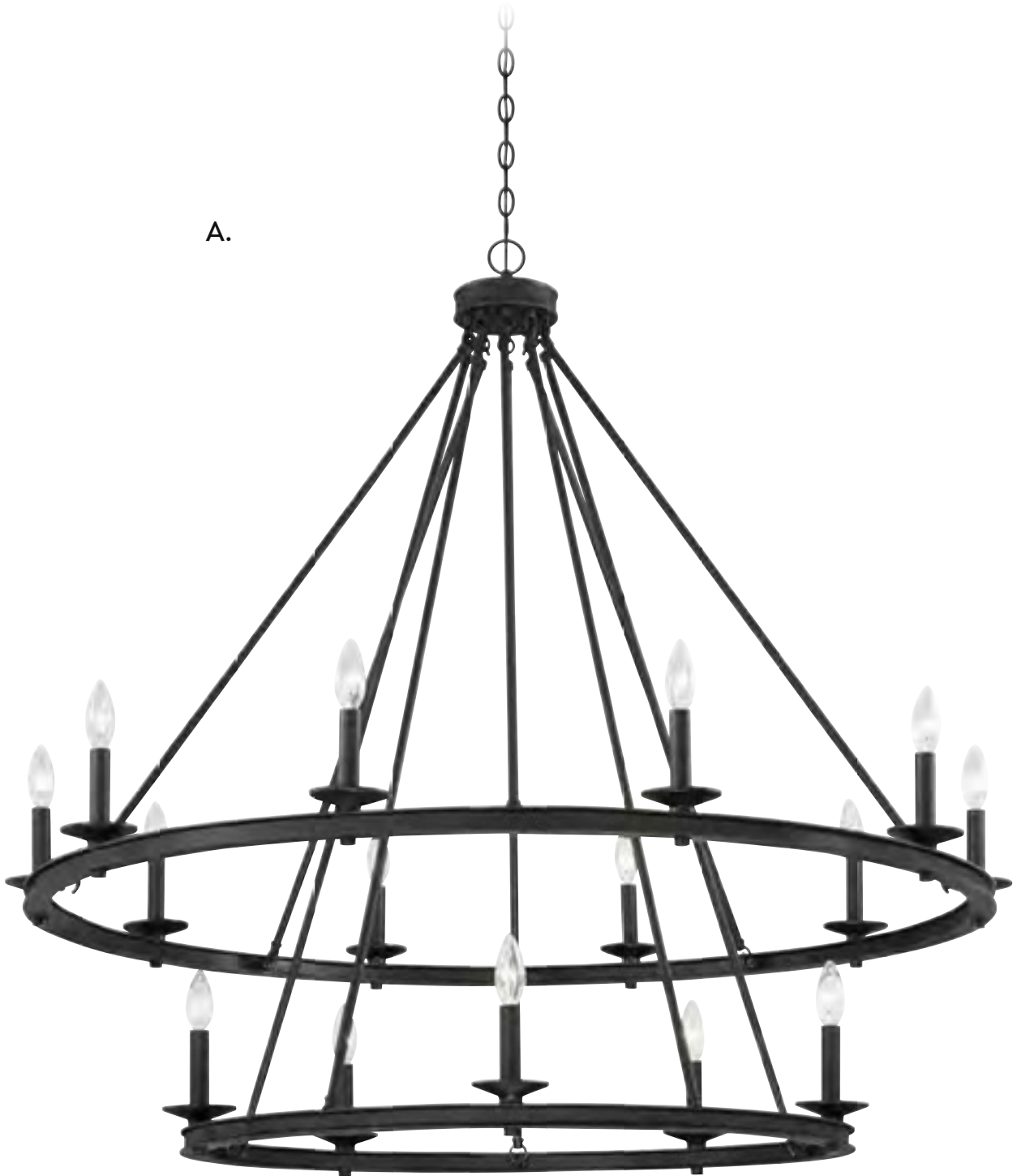

A. 1-312-15-89  
15-Light Chandelier  
Matte Black Finish  
45"W x 42"H  
15C 60W  
Metal Candle Covers

# MIDDLETON

---

A.

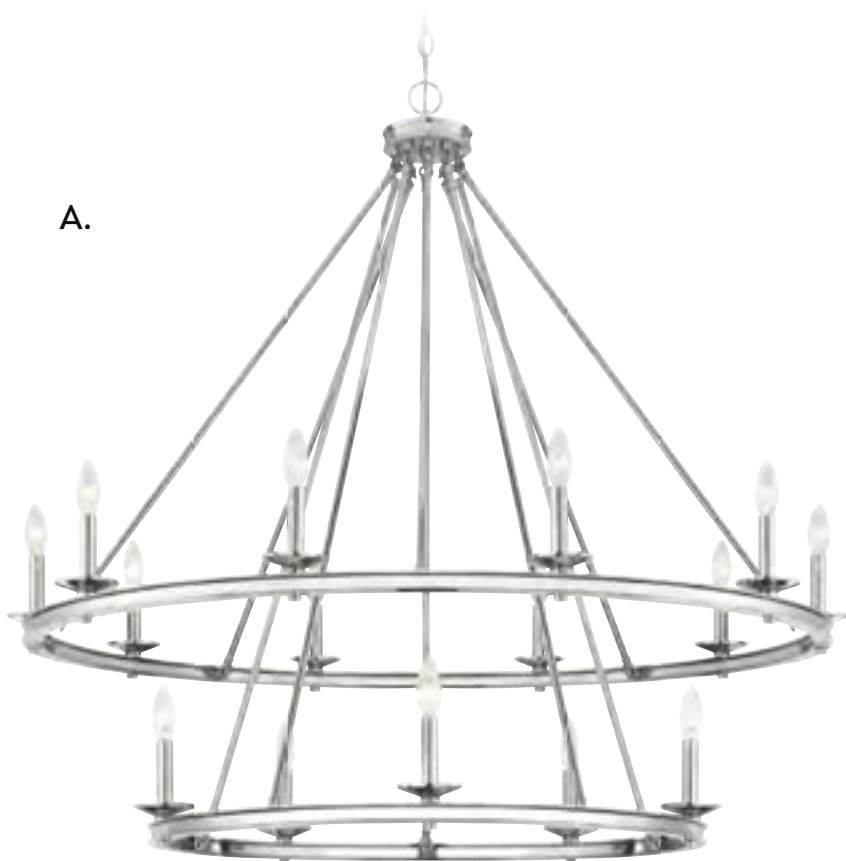

A. **1-312-15-109**  
15-Light Chandelier  
Polished Nickel Finish  
45"W x 42"H  
15C 60W  
Metal Candle Covers

B. **1-312-15-322**  
15-Light Chandelier  
Warm Brass Finish  
45"W x 42"H  
15C 60W  
Metal Candle Covers

C. **1-312-15-SN**  
15-Light Chandelier  
Satin Nickel Finish  
45"W x 42"H  
15C 60W  
Metal Candle Covers

D. **1-312-15-44**  
15-Light Chandelier  
Classic Bronze Finish  
45"W x 42"H  
15C 60W  
Metal Candle Covers

B.





# MIDDLETON

---

C.



D.

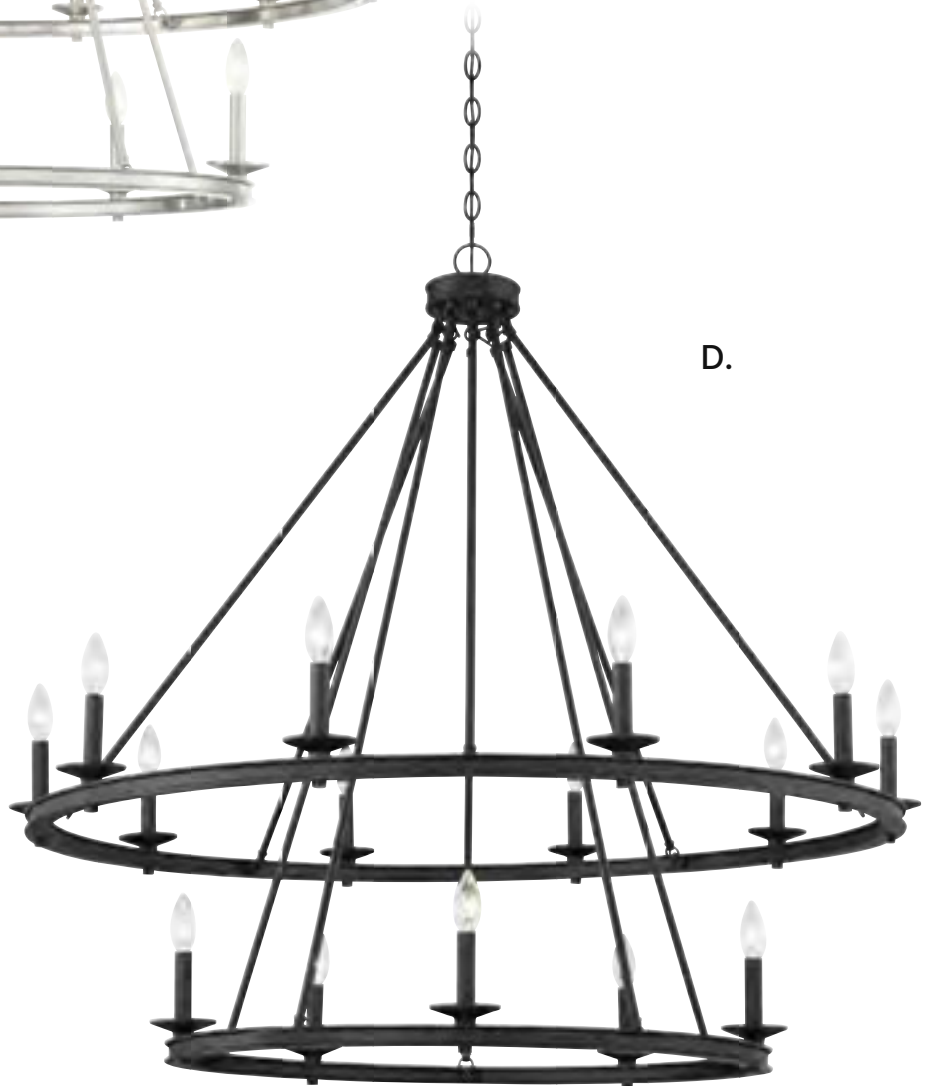

# TOWNSEND

---

A.



B.



C.

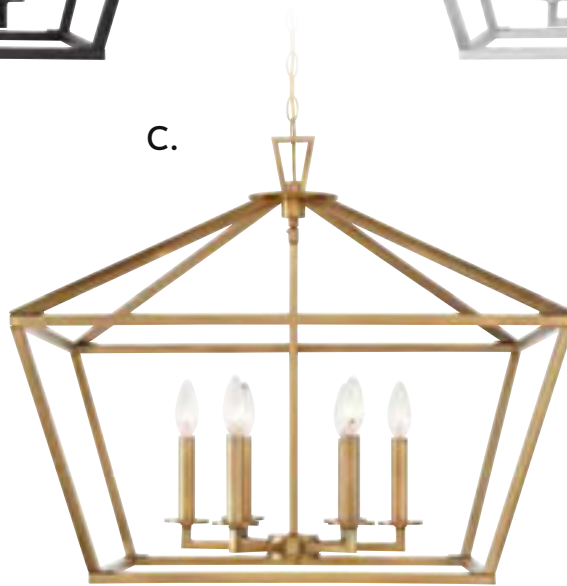

D.

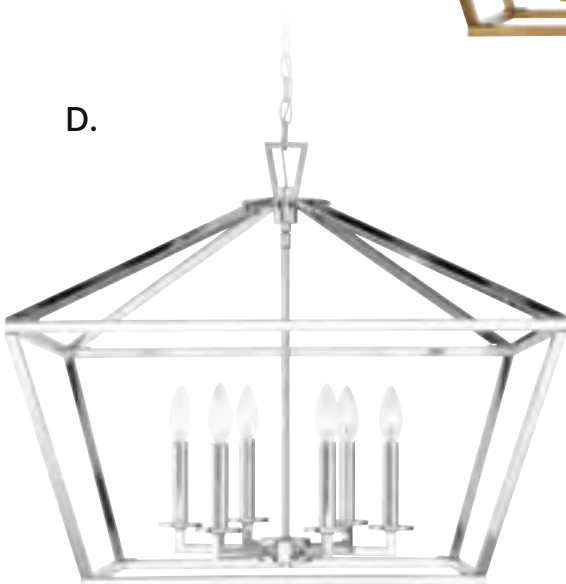

E.

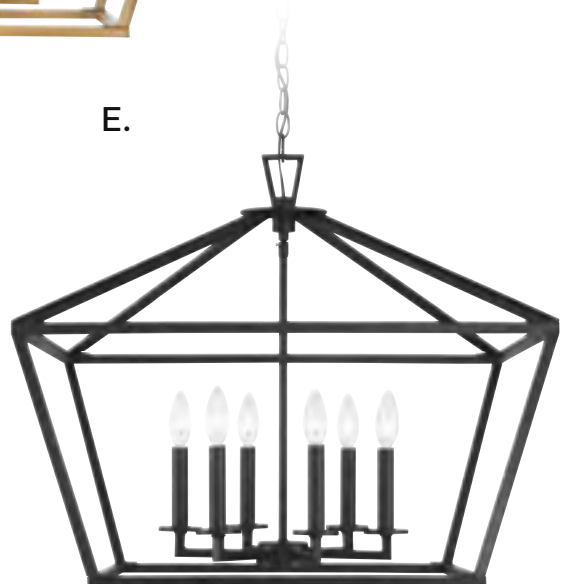

# TOWNSEND



**A. 3-325-6-44**  
6-Light Pendant  
Classic Bronze Finish  
26"W x 23-1/2"H  
6C 60W  
Metal Candle Covers

**B. 3-325-6-SN**  
6-Light Pendant  
Satin Nickel Finish  
26"W x 23-1/2"H  
6C 60W  
Metal Candle Covers

**C. 3-325-6-322**  
6-Light Pendant  
Warm Brass Finish  
26"W x 23-1/2"H  
6C 60W  
Metal Candle Covers

**D. 3-325-6-109**  
6-Light Pendant  
Polished Nickel Finish  
26"W x 23-1/2"H  
6C 60W  
Metal Candle Covers

**E. 3-325-6-89**  
6-Light Pendant  
Matte Black Finish  
26"W x 23-1/2"H  
6C 60W  
Metal Candle Covers

# TOWNSEND



**A. 3-320-3-44**

3-Light Pendant  
Classic Bronze Finish  
10"W x 15"H  
3C 60W  
Metal Candle Covers

**B. 3-320-3-SN**

3-Light Pendant  
Satin Nickel Finish  
10"W x 15"H  
3C 60W  
Metal Candle Covers

**C. 3-320-3-322**

3-Light Pendant  
Warm Brass Finish  
10"W x 15"H  
3C 60W  
Metal Candle Covers

**D. 3-320-3-109**

3-Light Pendant  
Polished Nickel Finish  
10"W x 15"H  
3C 60W  
Metal Candle Covers

**E. 3-320-3-89**

3-Light Pendant  
Matte Black Finish  
10"W x 15"H  
3C 60W  
Metal Candle Covers

# TOWNSEND

A.



B.

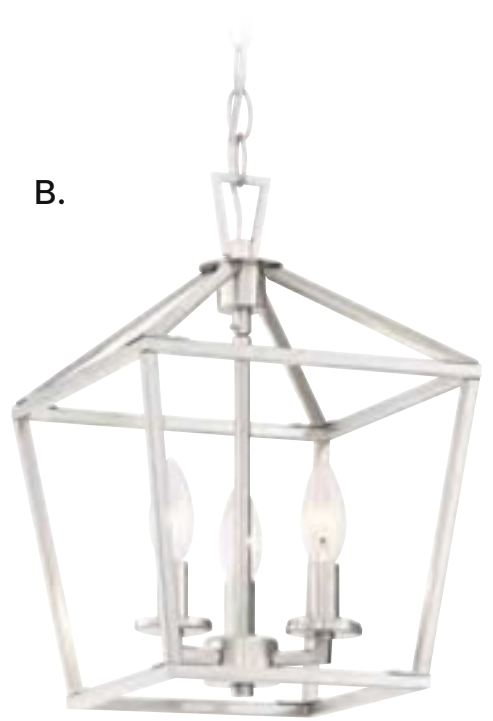

C.

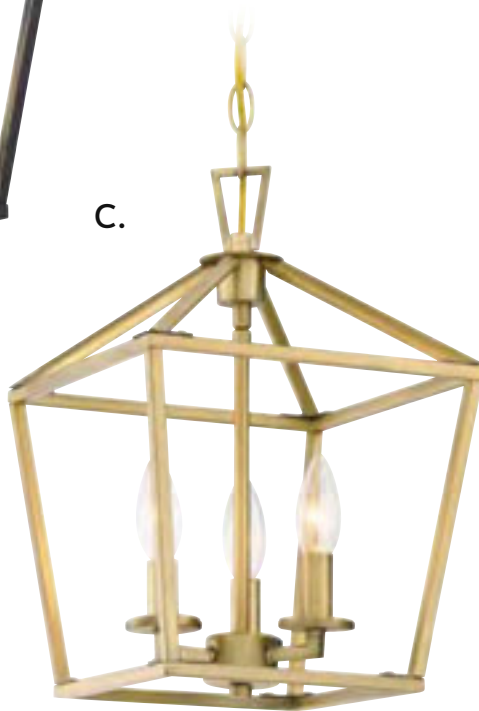

D.

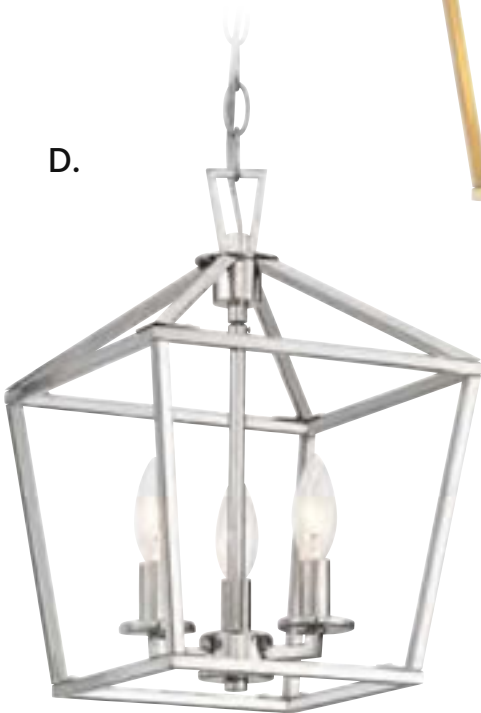

E.



# TOWNSEND

---

A.

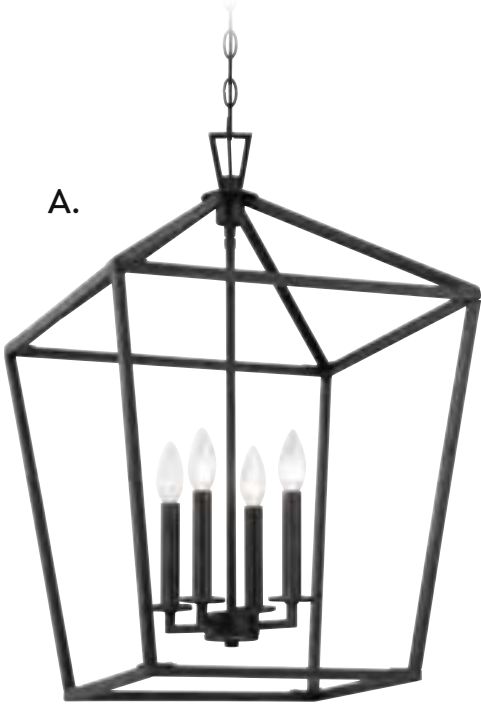

B.

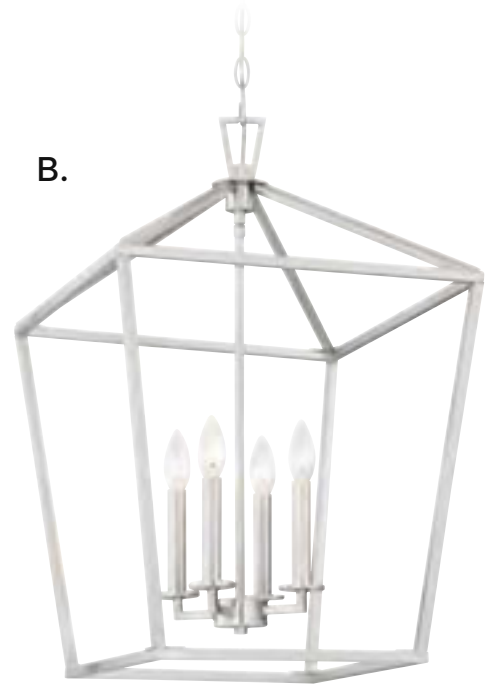

C.

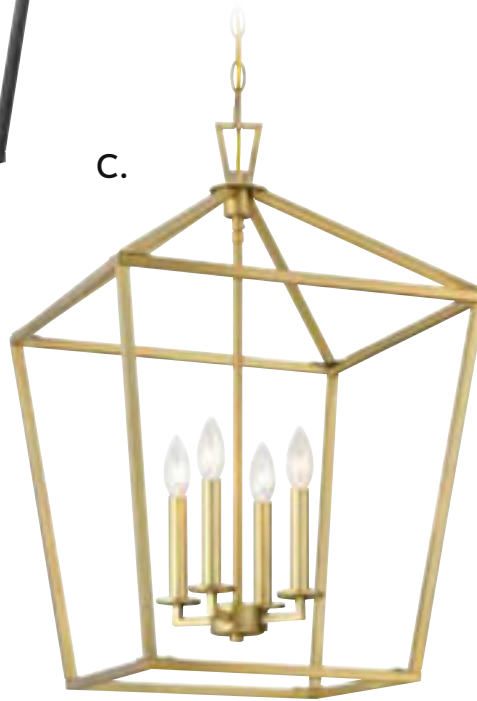

D.

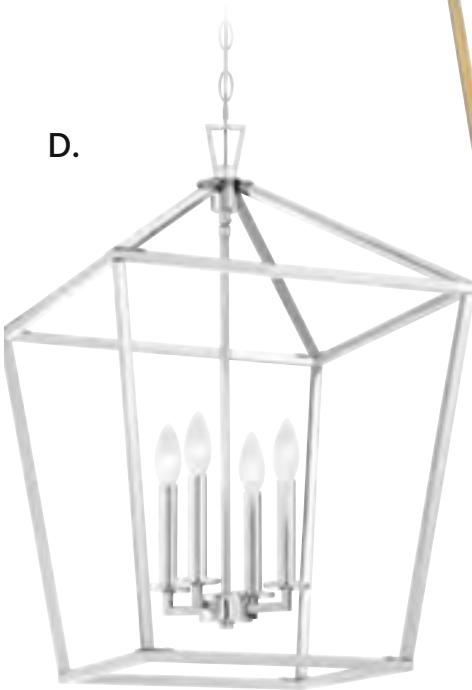

E.

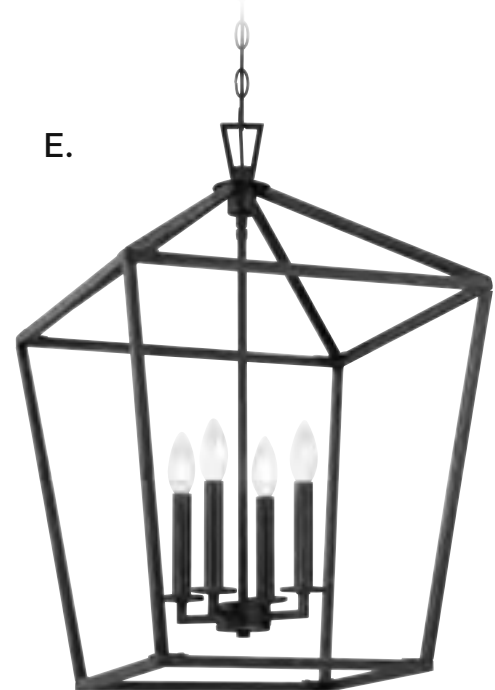

# TOWNSEND



**A. 3-321-4-44**  
4-Light Pendant  
Classic Bronze Finish  
17"W x 26"H  
4C 60W  
Metal Candle Covers

**B. 3-321-4-SN**  
4-Light Pendant  
Satin Nickel Finish  
17"W x 26"H  
4C 60W  
Metal Candle Covers

**C. 3-321-4-322**  
4-Light Pendant  
Warm Brass Finish  
17"W x 26"H  
4C 60W  
Metal Candle Covers

**D. 3-321-4-109**  
4-Light Pendant  
Polished Nickel Finish  
17"W x 26"H  
4C 60W  
Metal Candle Covers

**E. 3-321-4-89**  
4-Light Pendant  
Matte Black Finish  
17"W x 26"H  
4C 60W  
Metal Candle Covers

# TOWNSEND



**A. 3-322-6-44**

6-Light Pendant  
Classic Bronze Finish  
24"W x 36-1/2"H  
6C 60W  
Metal Candle Covers

**B. 3-322-6-SN**

6-Light Pendant  
Satin Nickel Finish  
24"W x 36-1/2"H  
6C 60W  
Metal Candle Covers

**C. 3-322-6-322**

6-Light Pendant  
Warm Brass Finish  
24"W x 36-1/2"H  
6C 60W  
Metal Candle Covers

**D. 3-322-6-109**

6-Light Pendant  
Polished Nickel Finish  
24"W x 36-1/2"H  
6C 60W  
Metal Candle Covers

**E. 3-322-6-89**

6-Light Pendant  
Matte Black Finish  
24"W x 36-1/2"H  
6C 60W  
Metal Candle Covers



# TOWNSEND

A.

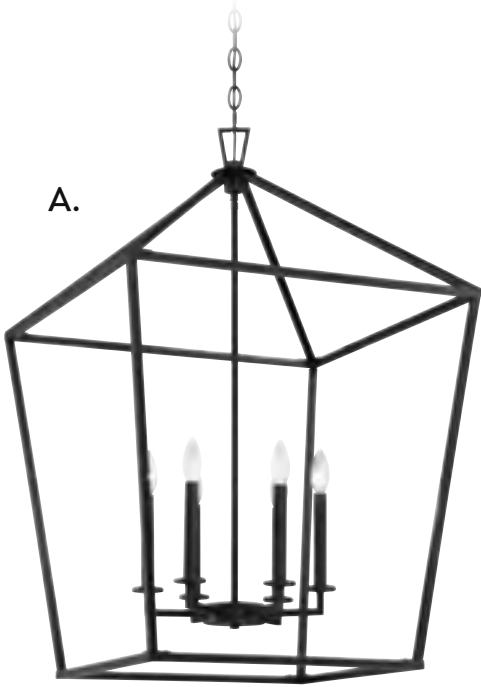

B.

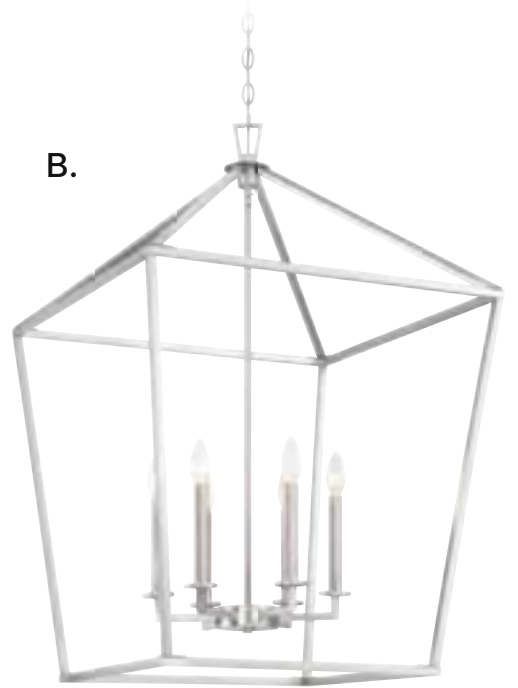

C.

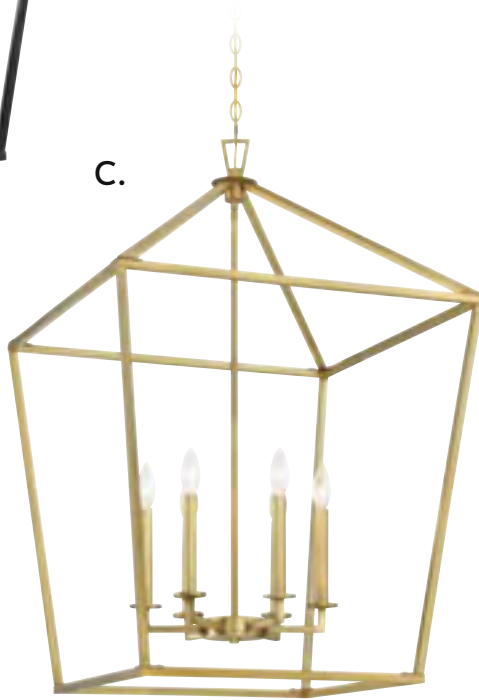

D.

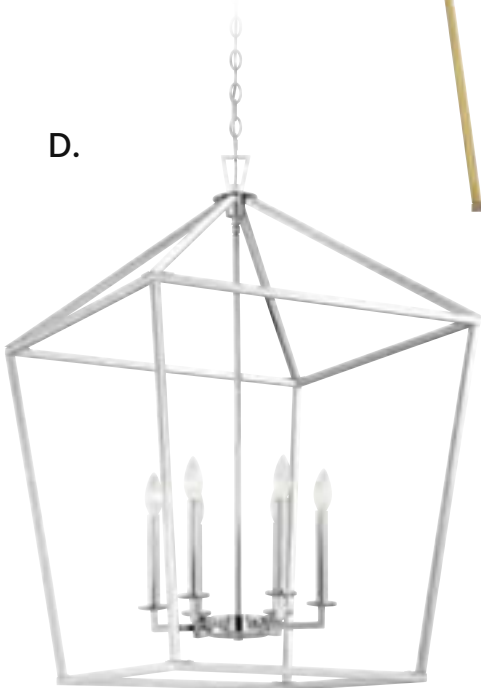

E.

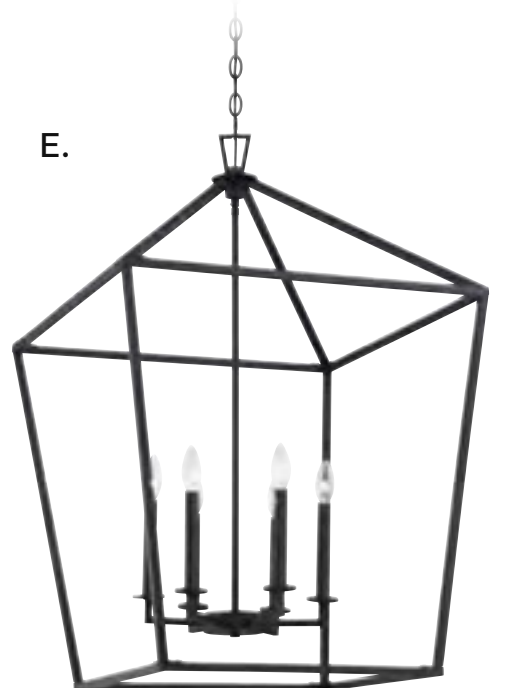

# TOWNSEND

---

A.



B.



C.

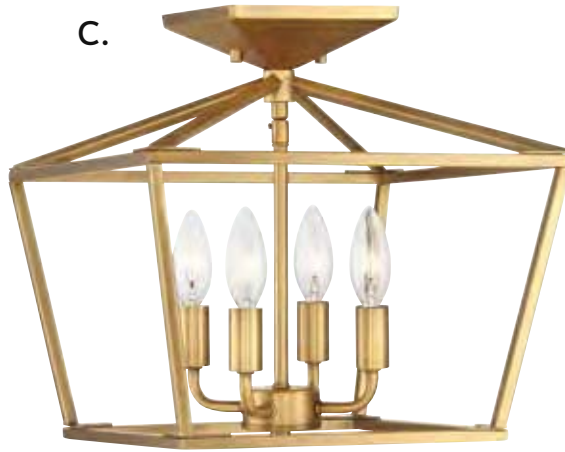

D.



E.



# TOWNSEND



**A. 6-328-4-44**  
4-Light Semi-Flush  
Classic Bronze Finish  
13"W x 13"H  
4C 60W  
Metal Candle Covers

**B. 6-328-4-SN**  
4-Light Semi-Flush  
Satin Nickel Finish  
13"W x 13"H  
4C 60W  
Metal Candle Covers

**C. 6-328-4-322**  
4-Light Semi-Flush  
Warm Brass Finish  
13"W x 13"H  
4C 60W  
Metal Candle Covers

**D. 6-328-4-109**  
4-Light Semi-Flush  
Polished Nickel Finish  
13"W x 13"H  
4C 60W  
Metal Candle Covers

**E. 6-328-4-89**  
4-Light Semi-Flush  
Matte Black Finish  
13"W x 13"H  
4C 60W  
Metal Candle Covers

# TOWNSEND



**A. 1-323-3-44**

3-Light Linear Chandelier  
Classic Bronze Finish  
32"L x 16"W x 21"H  
3C 60W  
Metal Candle Covers

**B. 1-323-3-SN**

3-Light Linear Chandelier  
Satin Nickel Finish  
32"L x 16"W x 21"H  
3C 60W  
Metal Candle Covers

**C. 1-323-3-322**

3-Light Linear Chandelier  
Warm Brass Finish  
32"L x 16"W x 21"H  
3C 60W  
Metal Candle Covers

**D. 1-323-3-109**

3-Light Linear Chandelier  
Polished Nickel Finish  
32"L x 16"W x 21"H  
3C 60W  
Metal Candle Covers

**E. 1-323-3-89**

3-Light Linear Chandelier  
Matte Black Finish  
32"L x 16"W x 21"H  
3C 60W  
Metal Candle Covers

# TOWNSEND

A.

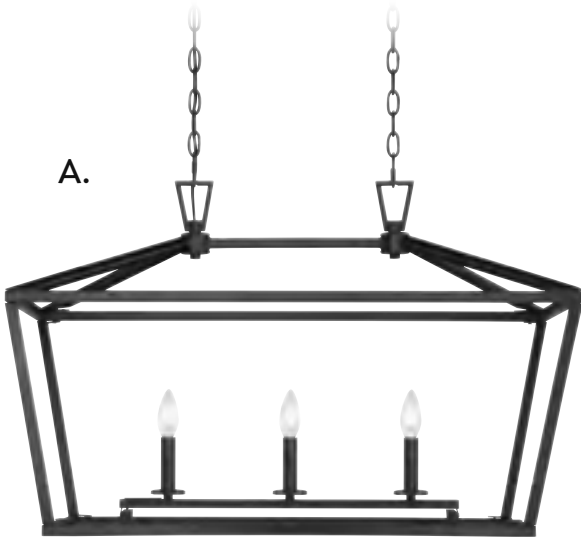

B.

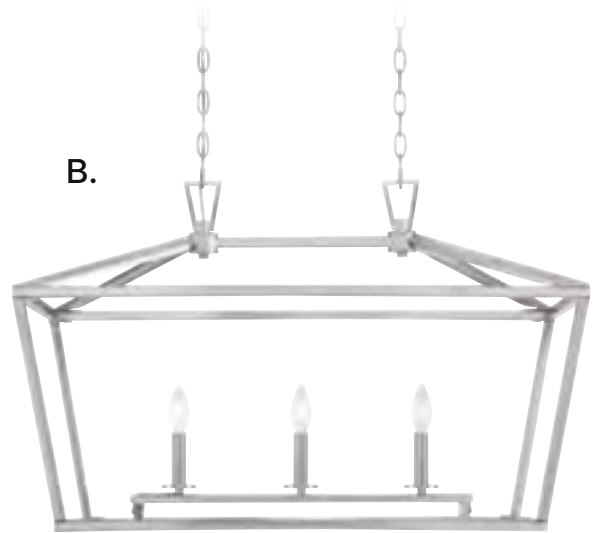

C.



D.

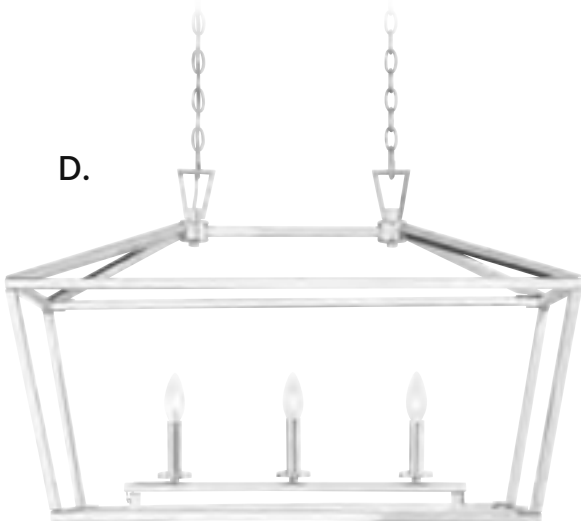

E.

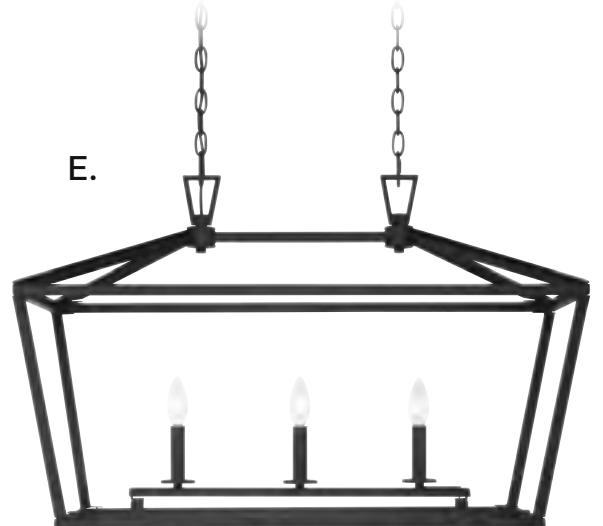

# TOWNSEND

---

A.

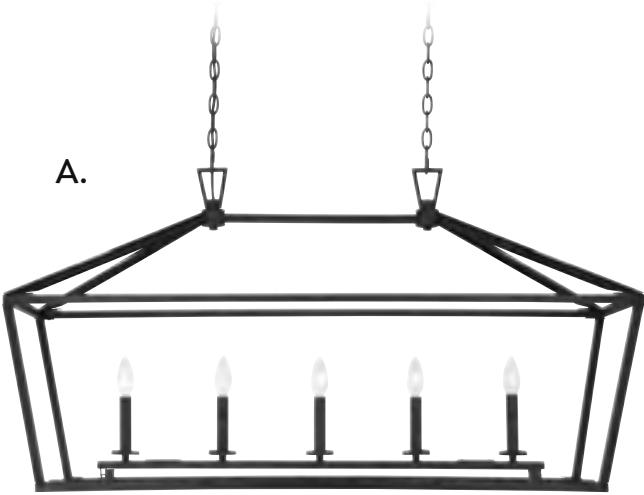

B.

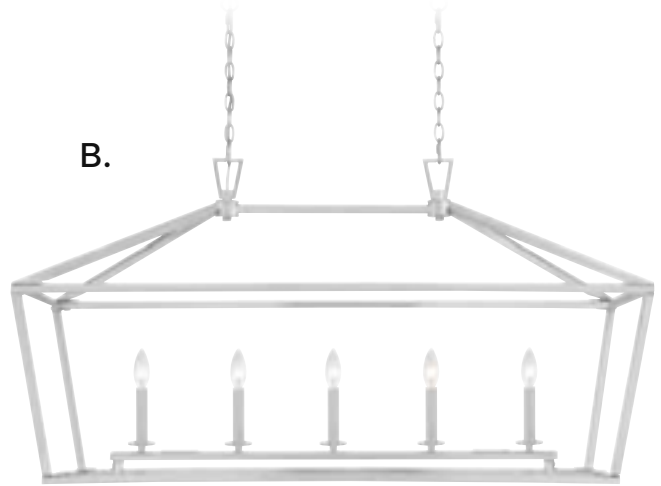

C.

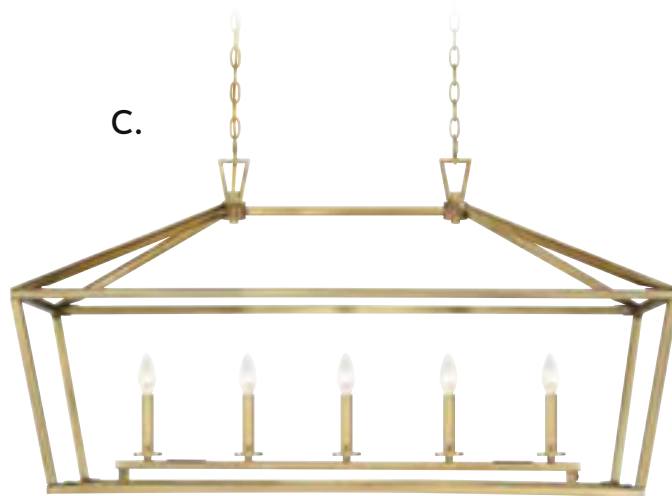

D.

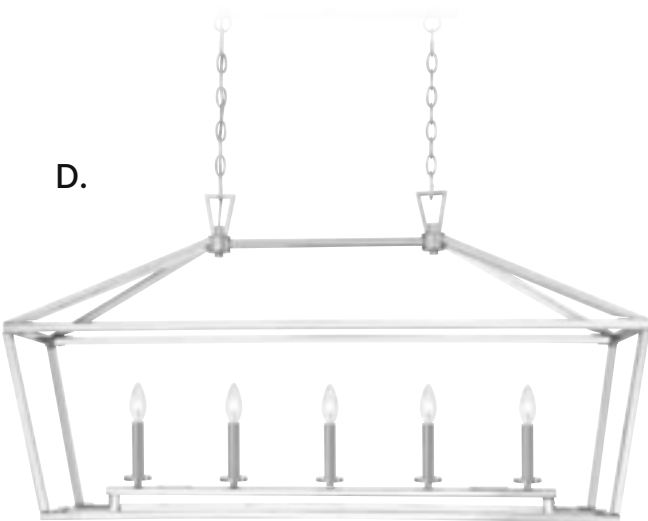

E.

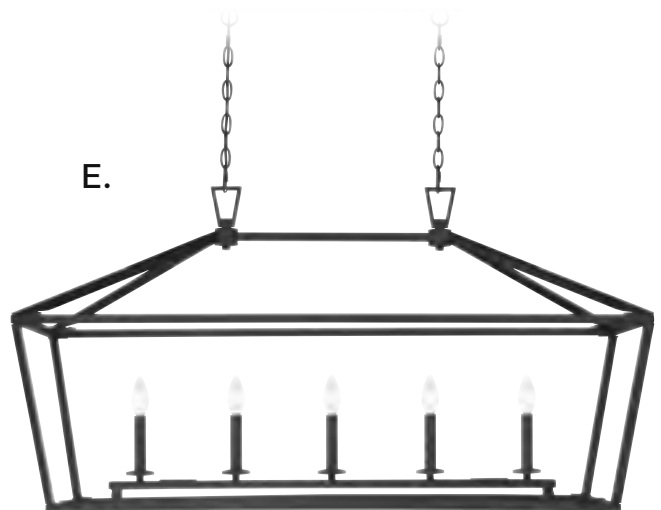

# TOWNSEND



**A. 1-324-5-44**  
5-Light Linear Chandelier  
Classic Bronze Finish  
44"L x 16"W x 23-1/2"H  
5C 60W  
Metal Candle Covers

**B. 1-324-5-SN**  
5-Light Linear Chandelier  
Satin Nickel Finish  
44"L x 16"W x 23-1/2"H  
5C 60W  
Metal Candle Covers

**C. 1-324-5-322**  
5-Light Linear Chandelier  
Warm Brass Finish  
44"L x 16"W x 23-1/2"H  
5C 60W  
Metal Candle Covers

**D. 1-324-5-109**  
5-Light Linear Chandelier  
Polished Nickel Finish  
44"L x 16"W x 23-1/2"H  
5C 60W  
Metal Candle Covers

**E. 1-324-5-89**  
5-Light Linear Chandelier  
Matte Black Finish  
44"L x 16"W x 23-1/2"H  
5C 60W  
Metal Candle Covers

# DENTON

---

A.



B.



C.







**A. 1-326-3-322**  
3-Light Linear Chandelier  
Warm Brass Finish  
32"L x 12"W x 10-1/2"H  
Adj H 10-1/2" - 65-1/2"  
3E 60W  
30° Swivel

**B. 1-326-3-109**  
3-Light Linear Chandelier  
Polished Nickel Finish  
32"L x 12"W x 10-1/2"H  
Adj H 10-1/2" - 65-1/2"  
3E 60W  
30° Swivel

**C. 1-326-3-44**  
3-Light Linear Chandelier  
Classic Bronze Finish  
32"L x 12"W x 10-1/2"H  
Adj H 10-1/2" - 65-1/2"  
3E 60W  
30° Swivel

\*Options: 7-EXT- Extension Rod - 9-1/2"

# DENTON

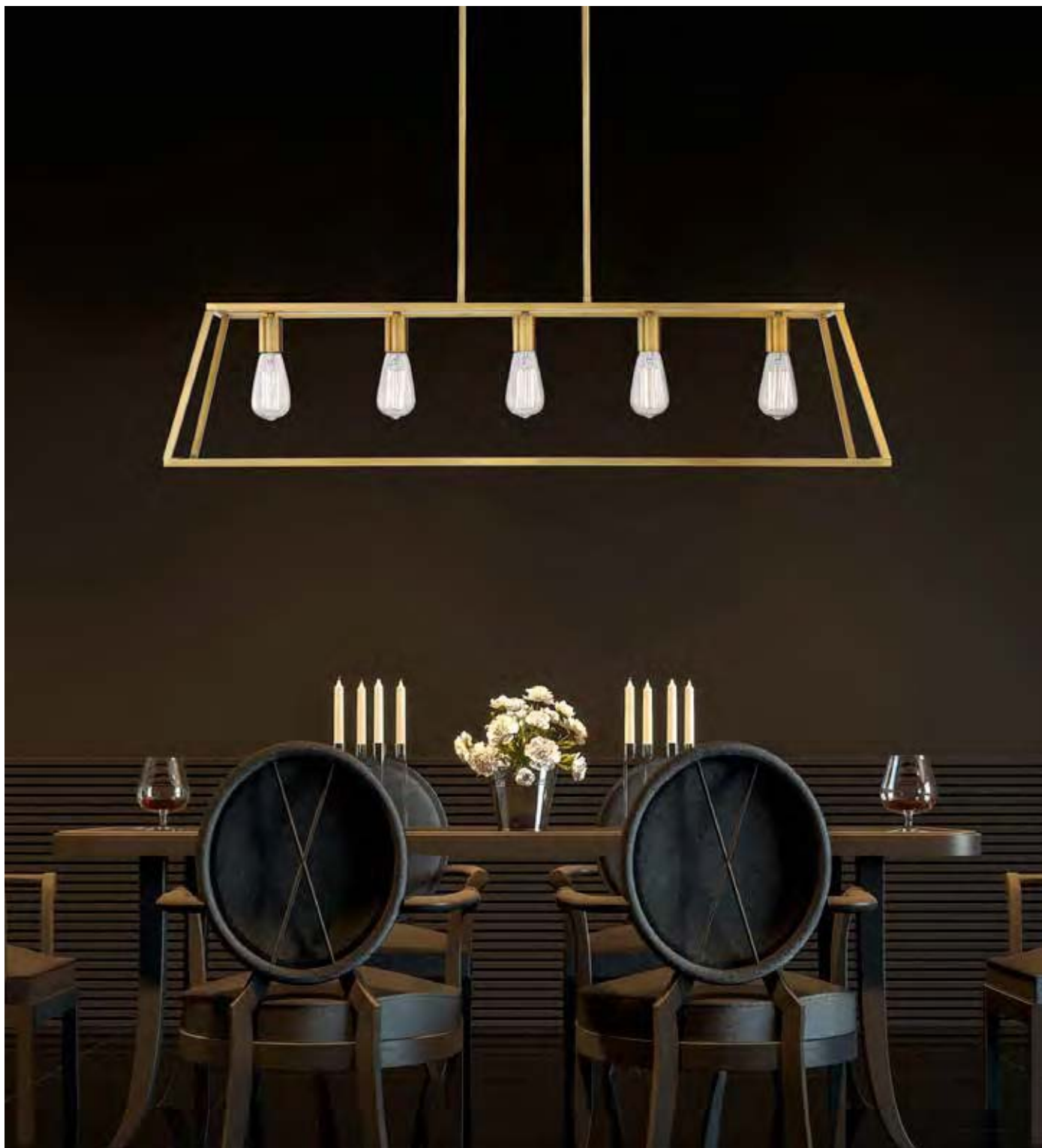

**A. 1-327-5-322**  
5-Light Linear Chandelier  
Warm Brass Finish  
44"L x 12"W x 10-1/2"H  
Adj H 10-1/2" - 65-1/2"  
5E 60W  
30° Swivel

**B. 1-327-5-109**  
5-Light Linear Chandelier  
Polished Nickel Finish  
44"L x 12"W x 10-1/2"H  
Adj H 10-1/2" - 65-1/2"  
5E 60W  
30° Swivel

**C. 1-327-5-44**  
5-Light Linear Chandelier  
Classic Bronze Finish  
44"L x 12"W x 10-1/2"H  
Adj H 10-1/2" - 65-1/2"  
5E 60W  
30° Swivel

# DENTON

A.



B.



C.



\*Options: 7-EXT- Extension Rod - 9-1/2"

# CHATHAM



**A. 1-305-6-89**

6-Light Chandelier  
Matte Black Finish  
28"W x 17-1/2"  
Adj H 17-1/2" - 74"  
6C 60W  
30° Swivel  
White Fabric Shades  
Metal Candle Covers

**B. 1-305-6-SN**

6-Light Chandelier  
Satin Nickel Finish  
28"W x 17-1/2"  
Adj H 17-1/2" - 74"  
6C 60W  
30° Swivel  
White Fabric Shades  
Metal Candle Covers

**C. 1-305-6-322**

6-Light Chandelier  
Warm Brass Finish  
28"W x 17-1/2"  
Adj H 17-1/2" - 74"  
6C 60W  
30° Swivel  
White Fabric Shades  
Metal Candle Covers

**D. 1-305-6-109**

6-Light Chandelier  
Polished Nickel Finish  
28"W x 17-1/2"  
Adj H 17-1/2" - 74"  
6C 60W  
30° Swivel  
White Fabric Shades  
Metal Candle Covers

**E. 1-305-6-44**

6-Light Chandelier  
Classic Bronze Finish  
28"W x 17-1/2"  
Adj H 17-1/2" - 74"  
6C 60W  
30° Swivel  
White Fabric Shades  
Metal Candle Covers

# CHATHAM

A.



B.



C.

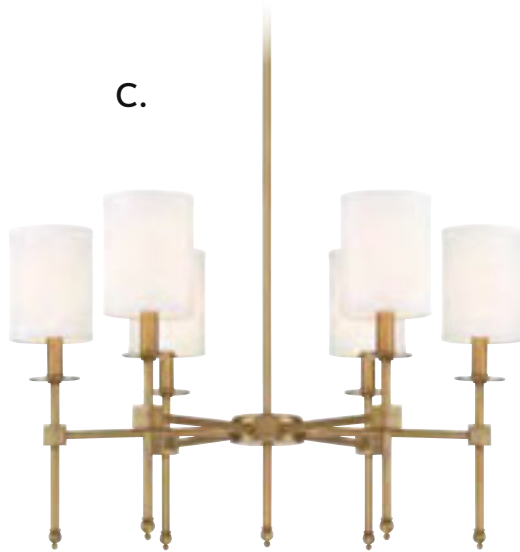

D.

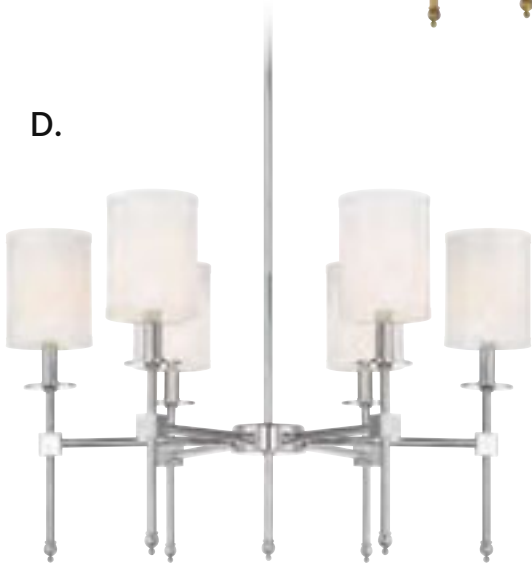

E.



Options: 7-EXT- Extension Rod - 9-1/2"

# CHATHAM

---

A.

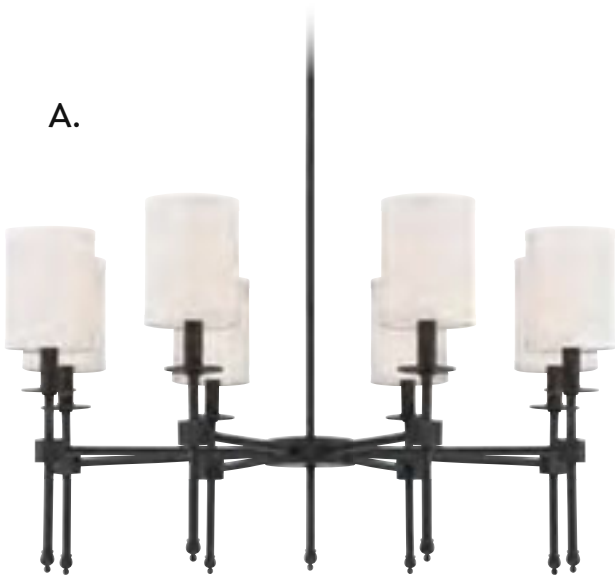

B.

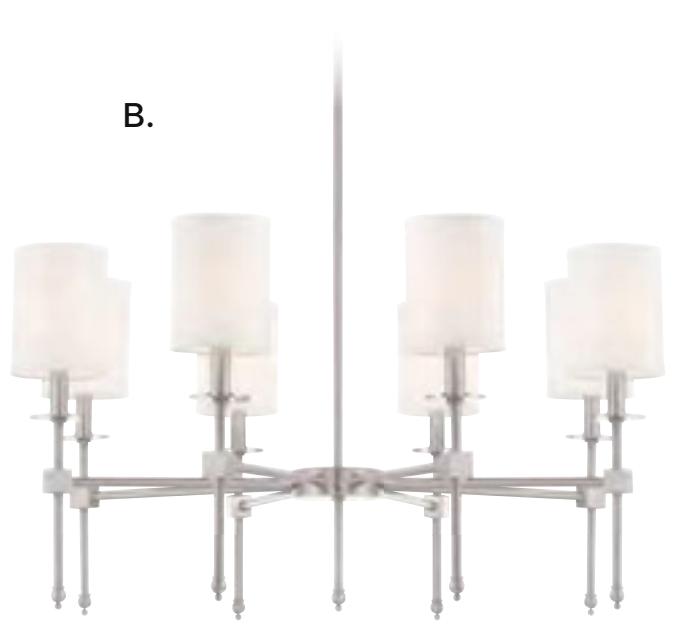

C.



D.

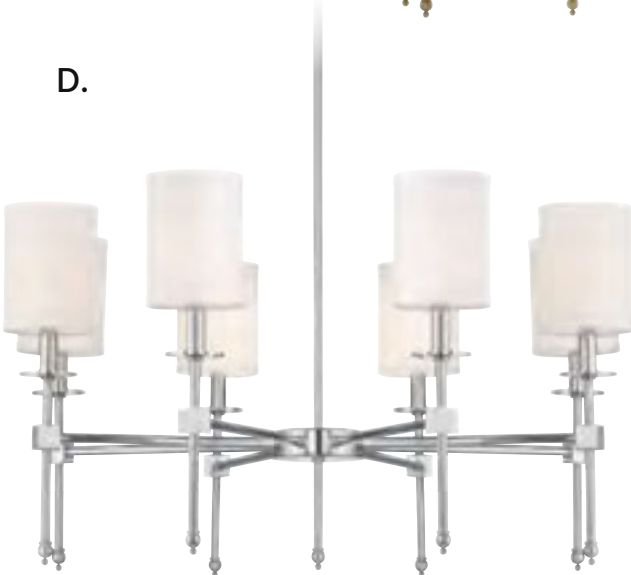

E.

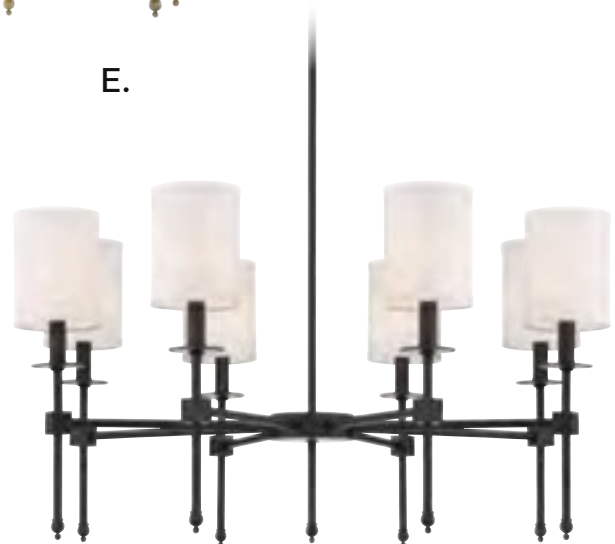

Options: 7-EXT- Extension Rod - 9-1/2"

# CHATHAM



**A. 1-306-8-89**  
8-Light Chandelier  
Matte Black Finish  
32"W x 17-1/2"H  
Adj H 17-1/2" - 74"  
8C 60W  
30° Swivel  
White Fabric Shades  
Metal Candle Covers

**B. 1-306-8-SN**  
8-Light Chandelier  
Satin Nickel Finish  
32"W x 17-1/2"H  
Adj H 17-1/2" - 74"  
8C 60W  
30° Swivel  
White Fabric Shades  
Metal Candle Covers

**C. 1-306-8-322**  
8-Light Chandelier  
Warm Brass Finish  
32"W x 17-1/2"H  
Adj H 17-1/2" - 74"  
8C 60W  
30° Swivel  
White Fabric Shades  
Metal Candle Covers

**D. 1-306-8-109**  
8-Light Chandelier  
Polished Nickel Finish  
32"W x 17-1/2"H  
Adj H 17-1/2" - 74"  
8C 60W  
30° Swivel  
White Fabric Shades  
Metal Candle Covers

**E. 1-306-8-44**  
8-Light Chandelier  
Classic Bronze Finish  
32"W x 17-1/2"H  
Adj H 17-1/2" - 74"  
8C 60W  
30° Swivel  
White Fabric Shades  
Metal Candle Covers

# CAMERON



**A. 1-2541-9-89**  
9-Light Chandelier  
Matte Black Finish  
35"W x 24"H  
Adj H 24" - 81"  
9C 40W  
30° Swivel  
White Fabric Shade  
Metal Candle Covers

**B. 1-2541-9-322**  
9-Light Chandelier  
Warm Brass Finish  
35"W x 24"H  
Adj H 24" - 81"  
9C 40W  
30° Swivel  
White Fabric Shade  
Metal Candle Covers

**C. 1-2541-9-109**  
9-Light Chandelier  
Polished Nickel Finish  
35"W x 24"H  
Adj H 24" - 81"  
9C 40W  
30° Swivel  
White Fabric Shade  
Metal Candle Covers



# CAMERON

\*A.



\*B.



\*C.



\*Options: 7-EXT- Extension Rod - 9-1/2"

# CAMERON

\*A.



\*B.



\*C.



Bath, Page 188

Sconce, Page 162

\*Options: 7-EXT- Extension Rod - 9-1/2"

# CAMERON



**A. 1-2540-5-89**  
5-Light Chandelier  
Matte Black Finish  
29"W x 13"H  
Adj H 13" - 70"  
5C 40W  
30° Swivel  
White Fabric Shade  
Metal Candle Covers

**B. 1-2540-5-109**  
5-Light Chandelier  
Polished Nickel Finish  
29"W x 13"H  
Adj H 13" - 70"  
5C 40W  
30° Swivel  
White Fabric Shade  
Metal Candle Covers

**C. 1-2540-5-322**  
5-Light Chandelier  
Warm Brass Finish  
29"W x 13"H  
Adj H 13" - 70"  
5C 40W  
30° Swivel  
White Fabric Shade  
Metal Candle Covers

# OCTAVE



**A. 7-4034-3-SN**  
3-Light Pendant  
Satin Nickel Finish  
15"W x 18"H  
3E 60W  
Clear Glass

**B. 1-4031-3-SN**  
3-Light Chandelier  
Satin Nickel Finish  
18"W x 16"H  
3E 60W  
Clear Glass

**C. 1-4032-5-SN**  
5-Light Chandelier  
Satin Nickel Finish  
23"W x 18-1/2"H  
5E 60W  
Clear Glass

**D. 1-4033-9-SN**  
9-Light Chandelier  
Satin Nickel Finish  
30"W x 28"H  
9E 60W  
Clear Glass

# OCTAVE

A.



B.

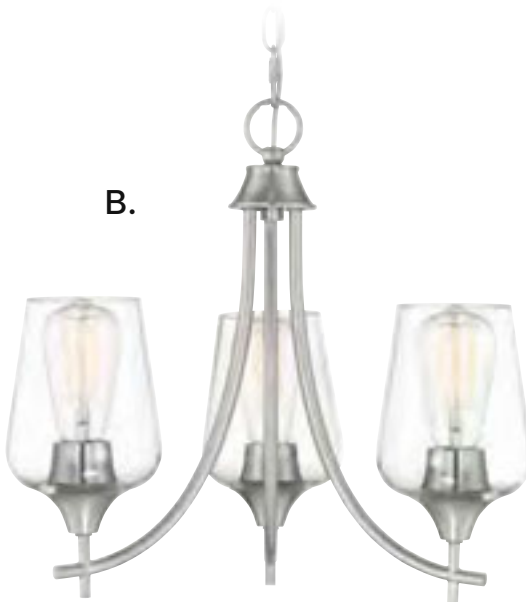

C.



D.



Ceiling, Page 139



Pendant, Page 131



Bath, Page 179



Sconce, Page 179

# OCTAVE



A.

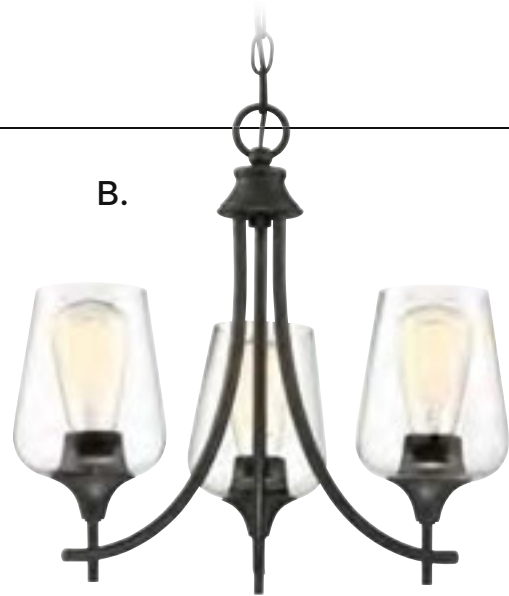

B.



C.



D.

A. 7-4034-3-13  
3-Light Pendant  
English Bronze Finish  
15"W x 18"H  
3E 60W  
Clear Glass

B. 1-4031-3-13  
3-Light Chandelier  
English Bronze Finish  
18"W x 16"H  
3E 60W  
Clear Glass

C. 1-4032-5-13  
5-Light Chandelier  
English Bronze Finish  
23"W x 18-1/2"H  
5E 60W  
Clear Glass

D. 1-4033-9-13  
9-Light Chandelier  
English Bronze Finish  
30"W x 28"H  
9E 60W  
Clear Glass



Ceiling, Page 139



Pendant, Page 131



Bath, Page 178



Sconce, Page 178

# OCTAVE

E.



F.

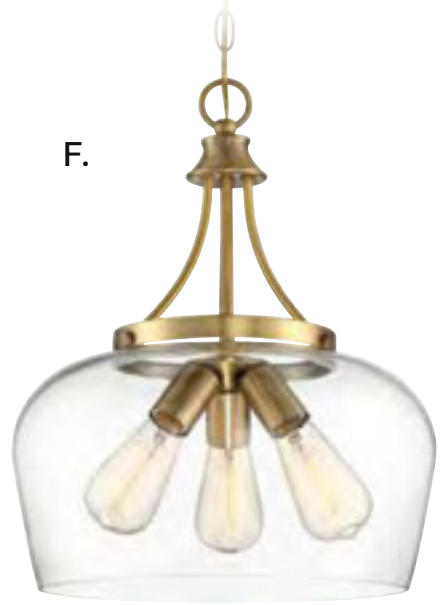

G.



H.



E. 1-4031-3-322  
3-Light Chandelier  
Warm Brass Finish  
18"W x 16"H  
3E 60W  
Clear Glass

F. 7-4034-3-322  
3-Light Pendant  
Warm Brass Finish  
15"W x 18"H  
3E 60W  
Clear Glass

G. 1-4033-9-322  
9-Light Chandelier  
Warm Brass Finish  
30"W x 28"H  
9E 60W  
Clear Glass

H. 1-4032-5-322  
5-Light Chandelier  
Warm Brass Finish  
23"W x 18-1/2"H  
5E 60W  
Clear Glass



Ceiling, Page 139



Pendant, Page 131



Bath, Page 178



Sconce, Page 178

# OCTAVE

A.

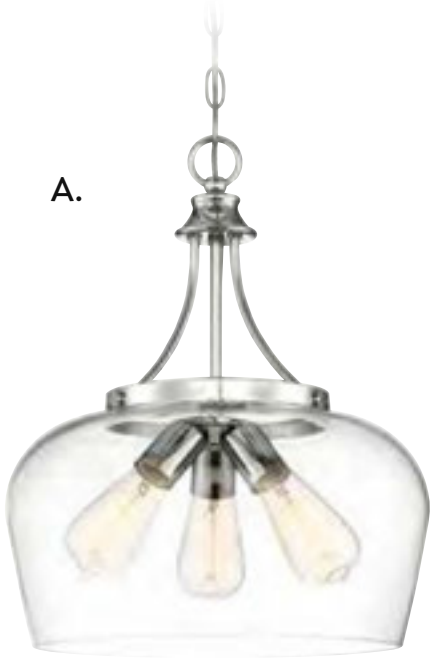

B.



C.



D.



**A. 7-4034-3-11**  
3-Light Pendant  
Polished Chrome Finish  
15"W x 18"H  
3E 60W  
Clear Glass

**B. 1-4031-3-11**  
3-Light Chandelier  
Polished Chrome Finish  
18"W x 16"H  
3E 60W  
Clear Glass

**C. 1-4032-5-11**  
5-Light Chandelier  
Polished Chrome Finish  
23"W x 18-1/2"H  
5E 60W  
Clear Glass

**D. 1-4033-9-11**  
9-Light Chandelier  
Polished Chrome Finish  
30"W x 28"H  
9E 60W  
Clear Glass



Ceiling, Page 139



Pendant, Page 131



Bath, Page 177



Sconce, Page 177



# OCTAVE

E.



F.



G.



H.



E. 1-4031-3-BK  
3-Light Chandelier  
Matte Black Finish  
18"W x 16"H  
3E 60W  
Clear Glass

F. 7-4034-3-BK  
3-Light Pendant  
Matte Black Finish  
15"W x 18"H  
3E 60W  
Clear Glass

G. 1-4033-9-BK  
9-Light Chandelier  
Matte Black Finish  
30"W x 28"H  
9E 60W  
Clear Glass

H. 1-4032-5-BK  
5-Light Chandelier  
Matte Black Finish  
23"W x 18-1/2"H  
5E 60W  
Clear Glass



Ceiling, Page 139



Pendant, Page 131



Bath, Page 177



Source, Page 177

# DUNBAR

---

A.

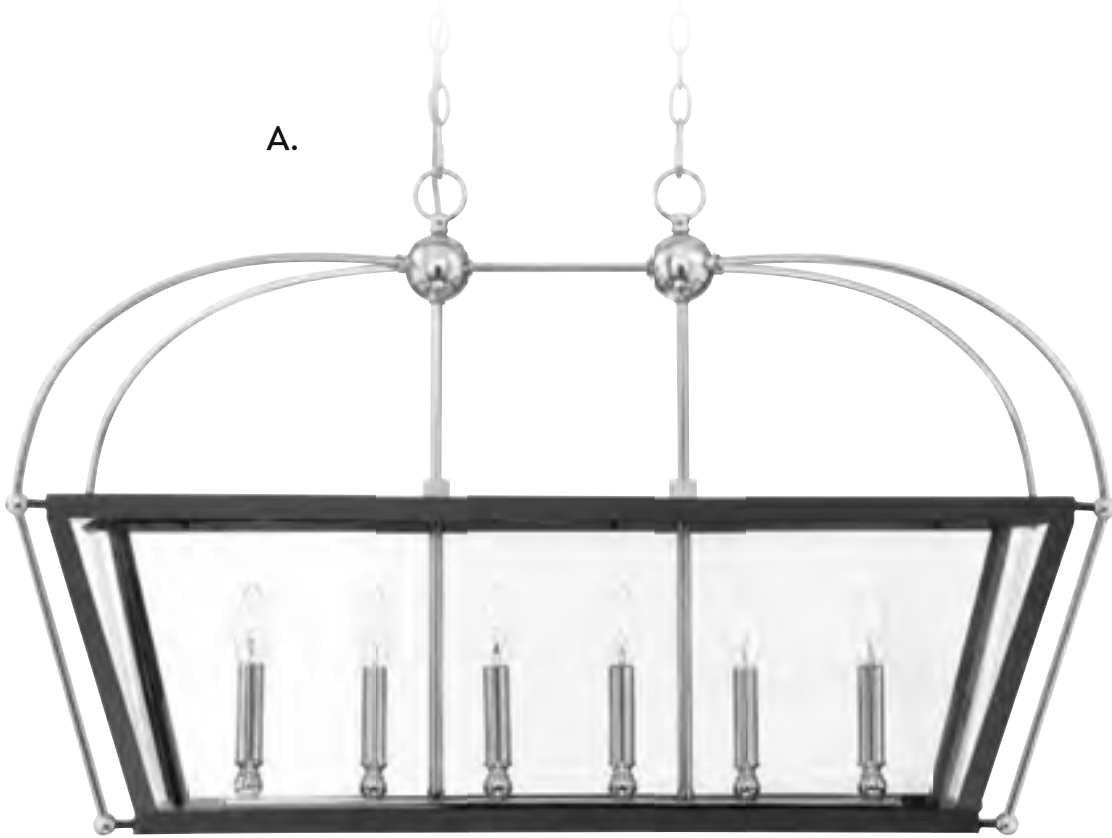

B.



# DUNBAR



**A. 1-9075-6-67**  
6-Light Linear Chandelier  
Matte Black w/ Polished Chrome Accents Finish  
36"L x 16"W x 22"H  
6C 60W  
Clear Glass  
Metal Candle Covers

**B. 1-9075-6-79**  
6-Light Linear Chandelier  
English Bronze & Warm Brass Finish  
36"L x 16"W x 22"H  
6C 60W  
Clear Glass  
Metal Candle Covers

# DUNBAR



**A. 3-9074-4-67**  
4-Light Foyer  
Matte Black w/ Polished  
Chrome Accents Finish  
14"W x 28"H  
4C 60W  
Clear Glass  
Metal Candle Covers

**B. 3-9074-8-67**  
8-Light Foyer  
Matte Black w/ Polished  
Chrome Accents Finish  
20"W x 38"H  
8C 60W  
Clear Glass  
Metal Candle Covers

**C. 3-9074-8-79**  
8-Light Foyer  
English Bronze & Warm  
Brass Finish  
20"W x 38"H  
8C 60W  
Clear Glass  
Metal Candle Covers

**D. 3-9074-4-79**  
4-Light Foyer  
English Bronze & Warm  
Brass Finish  
14"W x 28"H  
4C 60W  
Clear Glass  
Metal Candle Covers

# DUNBAR

A.



B.



C.



D.



# GALEA



**A. 7-6099-24-322**  
24-Light Pendant  
Warm Brass Finish  
23"W x 23"H  
Adj H 23" - 71-1/2"  
24C 25W  
30" Swivel

**B. 7-6099-24-109**  
24-Light Pendant  
Polished Nickel Finish  
23"W x 23"H  
Adj H 23" - 71-1/2"  
24C 25W  
30" Swivel

**C. 7-6099-24-44**  
24-Light Pendant  
Classic Bronze Finish  
23"W x 23"H  
Adj H 23" - 71-1/2"  
24C 25W  
30" Swivel

# GALEA

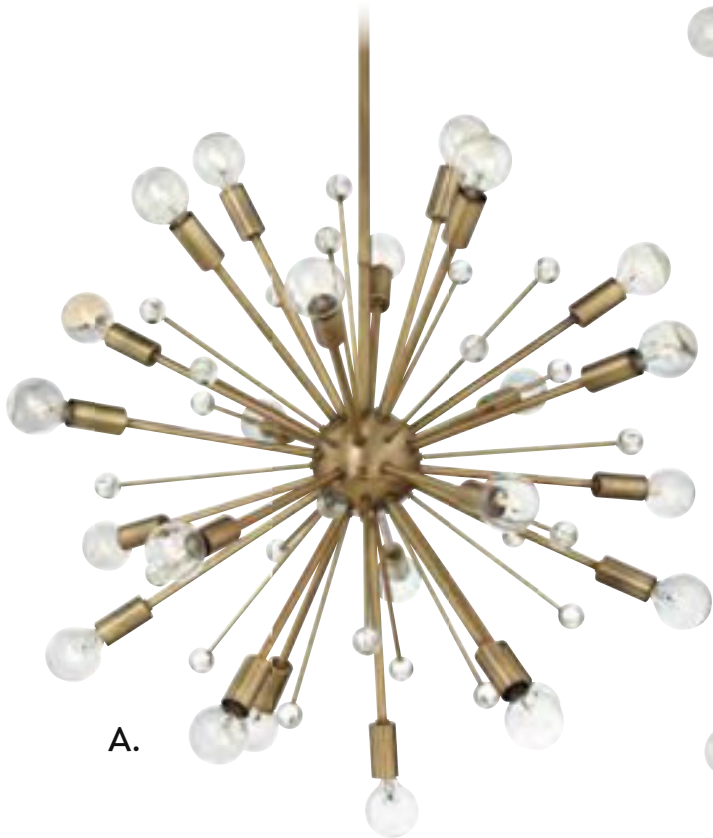

A.



B.



C.

Options: 7-EXT- Extension Rod - 9-1/2"

# MARLY

---

A.



B.



C.



Options: 7-EXT- Extension Rod - 9-1/2"





**A. 7-6098-12-109**  
 12-Light Pendant  
 Polished Nickel Finish  
 24-1/2"W x 26-1/2"H  
 Adj H 26-1/2" - 80-1/2"  
 12C 60W  
 30° Swivel

**B. 7-6098-12-44**  
 12-Light Pendant  
 Classic Bronze Finish  
 24-1/2"W x 26-1/2"H  
 Adj H 26-1/2" - 80-1/2"  
 12C 60W  
 30° Swivel

**C. 7-6098-12-322**  
 12-Light Pendant  
 Warm Brass Finish  
 24-1/2"W x 26-1/2"H  
 Adj H 26-1/2" - 80-1/2"  
 12C 60W  
 30° Swivel

# DUMONT

A.

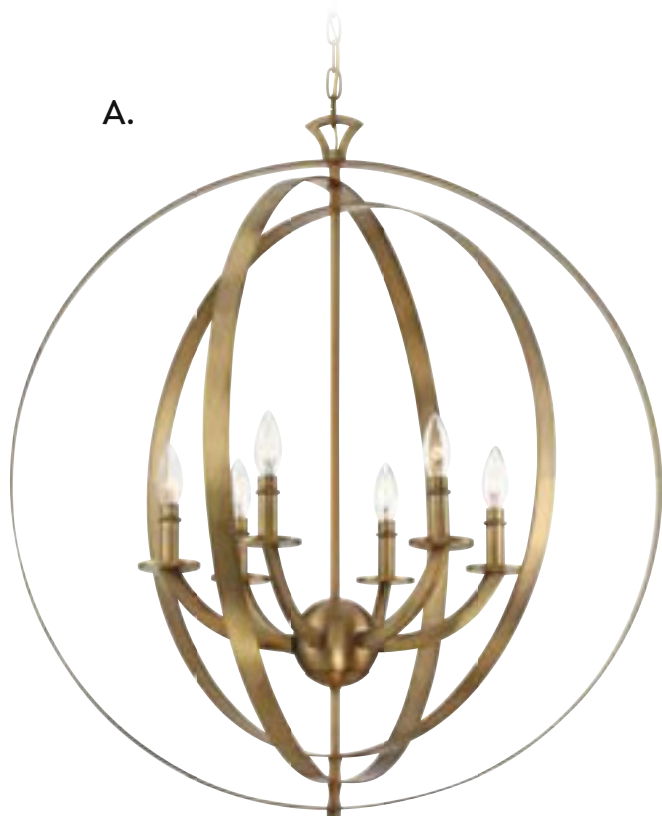

B.



C.

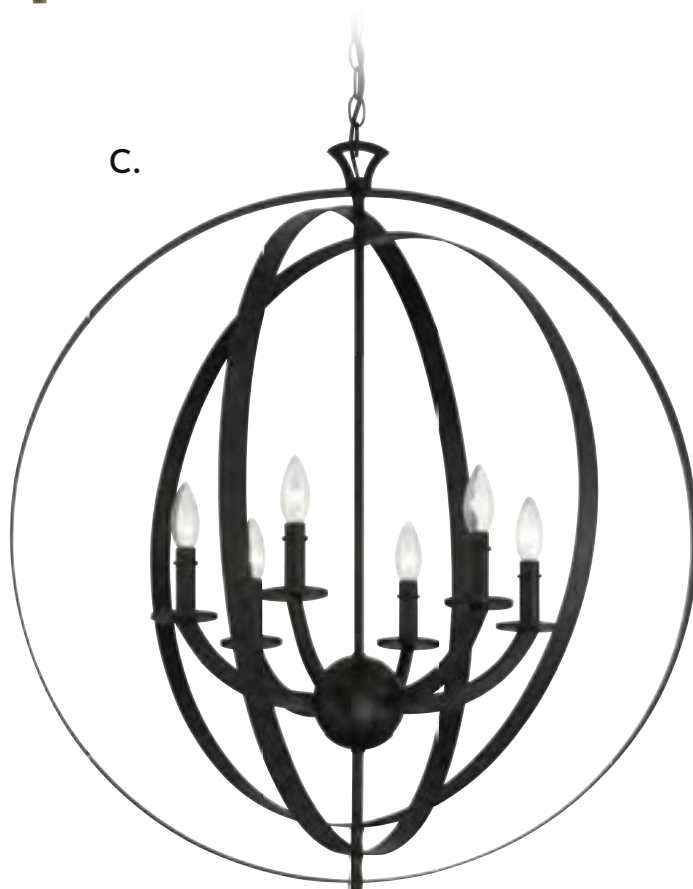

- A. **7-204-6-322**  
6-Light Pendant  
Warm Brass Finish  
32"W x 35-3/4"H  
6C 60W  
Metal Candle Covers
- B. **7-204-6-109**  
6-Light Pendant  
Polished Nickel Finish  
32"W x 35-3/4"H  
6C 60W  
Metal Candle Covers
- C. **7-204-6-44**  
6-Light Pendant  
Classic Bronze Finish  
32"W x 35-3/4"H  
6C 60W  
Metal Candle Covers



# WILLIAM



**A. 7-3103-4-322**

4-Light Pendant  
Warm Brass Finish  
24"W x 30"H  
4E 60W  
Linen Shade  
Frosted Glass

**B. 7-3103-4-109**

4-Light Pendant  
Polished Nickel Finish  
24"W x 30"H  
4E 60W  
Linen Shade  
Frosted Glass

**C. 7-3103-4-44**

4-Light Pendant  
Classic Bronze Finish  
24"W x 30"H  
4E 60W  
Linen Shade  
Frosted Glass



# WILLIAM



# WILLIAM



A.



B.

A. **3-3104-4-109**  
4-Light Pendant  
Polished Nickel Finish  
16"W x 33"H  
4C 60W  
Metal Candle Covers

B. **3-3104-4-322**  
4-Light Pendant  
Warm Brass Finish  
16"W x 33"H  
4C 60W  
Metal Candle Covers

C. **3-3104-4-44**  
4-Light Pendant  
Classic Bronze Finish  
16"W x 33"H  
4C 60W  
Metal Candle Covers



C.

# BRAXTON

---

A.

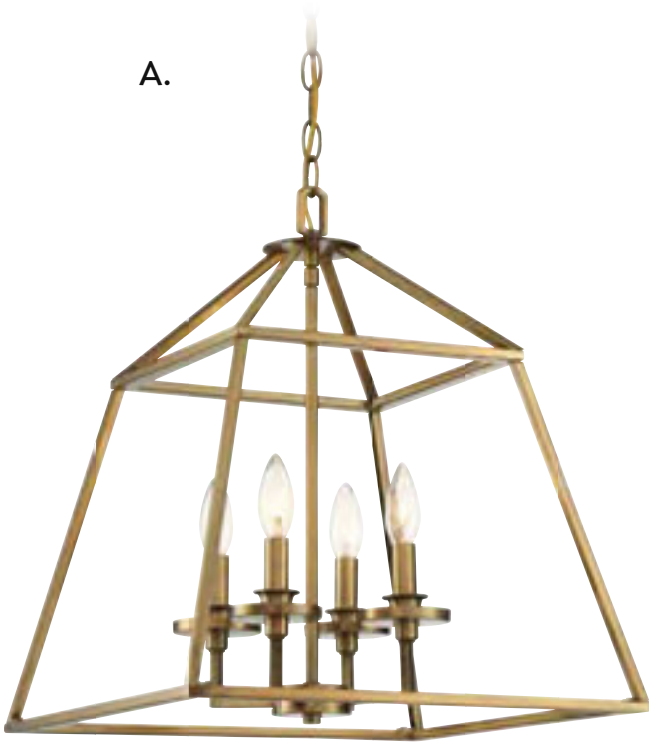

B.

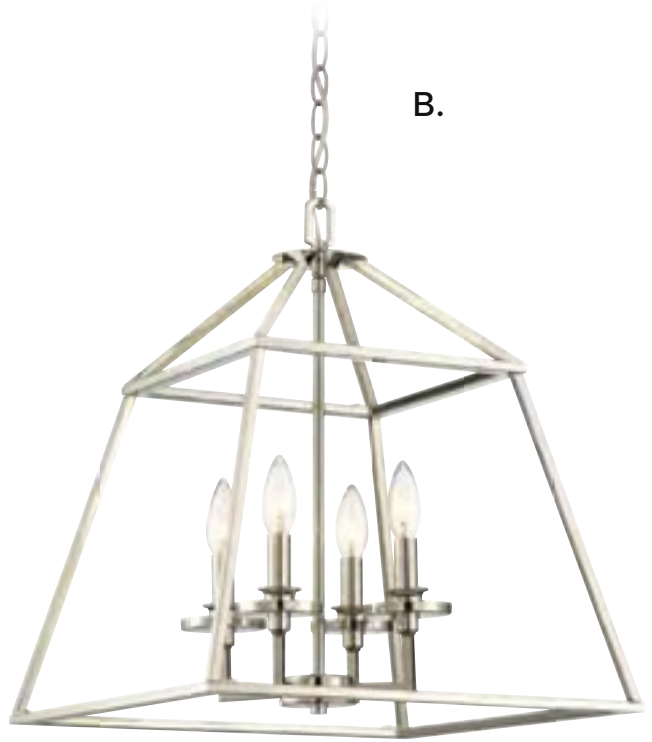

C.





# BRAXTON

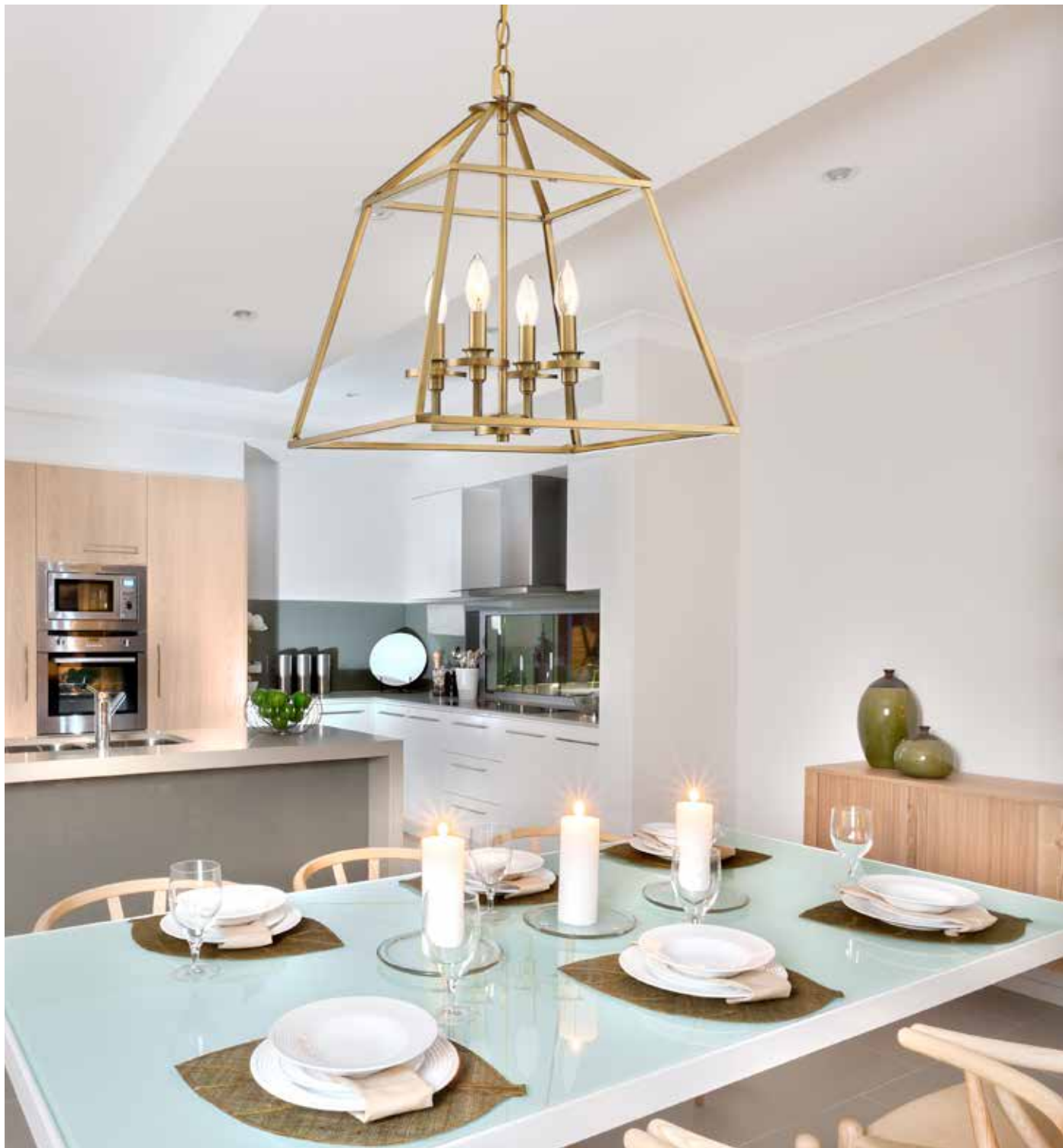

**A. 3-9099-4-322**  
4-Light Pendant  
Warm Brass Finish  
24"W x 19-1/2"H  
4C 60W  
Metal Candle Covers

**B. 3-9099-4-109**  
4-Light Pendant  
Polished Nickel Finish  
24"W x 19-1/2"H  
4C 60W  
Metal Candle Covers

**C. 3-9099-4-44**  
4-Light Pendant  
Classic Bronze Finish  
24"W x 19-1/2"H  
4C 60W  
Metal Candle Covers

# LILLY



**A. 7-203-2-322**  
2-Light Pendant  
Warm Brass Finish  
13"W x 20"H  
2E 60W  
White Opal Glass

**B. 7-203-2-109**  
2-Light Pendant  
Polished Nickel Finish  
13"W x 20"H  
2E 60W  
White Opal Glass

**C. 7-203-2-SN**  
2-Light Pendant  
Satin Nickel Finish  
13"W x 20"H  
2E 60W  
White Opal Glass

**D. 7-203-2-89**  
2-Light Pendant  
Matte Black Finish  
13"W x 20"H  
2E 60W  
White Opal Glass

**E. 7-203-2-44**  
2-Light Pendant  
Classic Bronze Finish  
13"W x 20"H  
2E 60W  
White Opal Glass

A.



B.



C.



D.



E.



# WESTBOURNE

\*A.

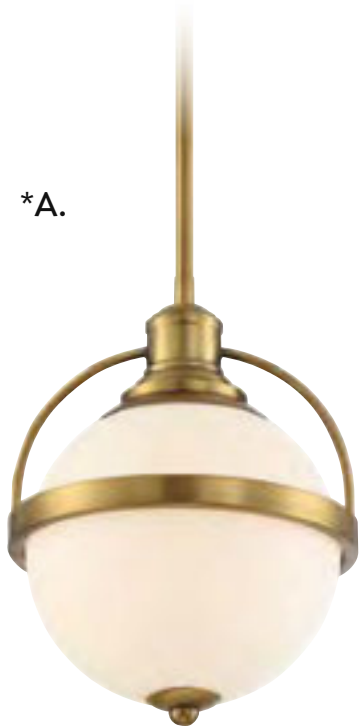

\*B.



**A. 7-3100-1-322**  
1-Light Mini-Pendant  
Warm Brass Finish  
8"W x 11-1/2"H  
Adj H 11-1/2" - 43"  
1E 60W  
90° Swivel  
White Opal Glass

**B. 7-3100-1-SN**  
1-Light Mini-Pendant  
Satin Nickel Finish  
8"W x 11-1/2"H  
Adj H 11-1/2" - 43"  
1E 60W  
90° Swivel  
White Opal Glass

\*Options: 7-EXT- Extension Rod - 9-1/2"

# WESTBOURNE



\*\*C.



\*\*D.



**C. 7-3102-1-322**  
1-Light Pendant  
Warm Brass Finish  
12-3/4"W x 16-1/2"H  
Adj H 16-1/2" - 73-1/2"  
1E 60W  
30° Swivel  
White Opal Glass

**D. 7-3102-1-SN**  
1-Light Pendant  
Satin Nickel Finish  
12-3/4"W x 16-1/2"H  
Adj H 16-1/2" - 73-1/2"  
1E 60W  
30° Swivel  
White Opal Glass

\*\*Options: 7-EXTLG- Extension Rod - 12"

# EPSILON



A.



\*B.



\*C.

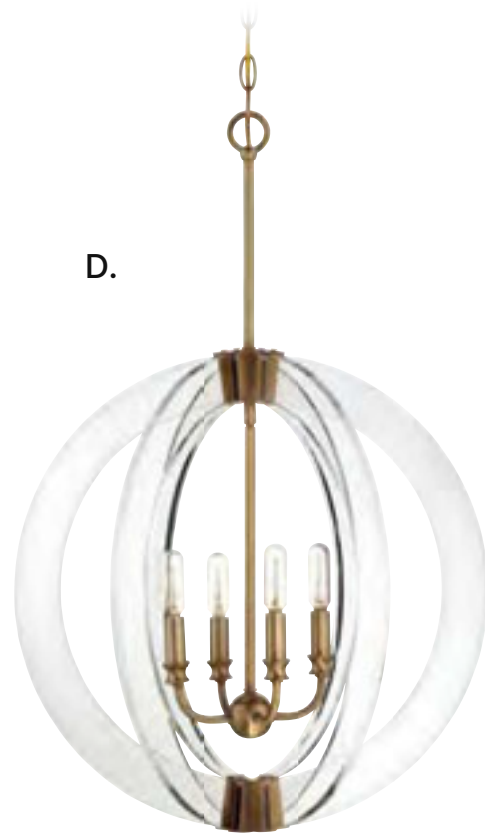

D.

A. 7-9161-4-109  
4-Light Pendant  
Polished Nickel Finish  
20"W x 30"H  
4C 60W  
Optic Acrylic  
Metal Candle Covers

B. 7-9160-1-322  
1-Light Pendant  
Warm Brass Finish  
12"W x 44-1/2"H  
1E 60W  
90° Swivel  
Optic Acrylic

C. 7-9160-1-109  
1-Light Pendant  
Polished Nickel Finish  
12"W x 44-1/2"H  
1E 60W  
90° Swivel  
Optic Acrylic

D. 7-9161-4-322  
4-Light Pendant  
Warm Brass Finish  
20"W x 30"H  
4C 60W  
Optic Acrylic  
Metal Candle Covers

\*Options: 7-EXT- Extension Rod - 9-1/2"

# STIRLING

\*E.



\*\*F.



\*\*G.



\*H.



**E. 7-200-3-322**

3-Light Pendant  
Warm Brass Finish  
12"W x 13"H  
Adj H 13"H - 70"  
3C 60W  
30° Swivel  
Crackled Glass  
Metal Candle Covers

**F. 7-201-4-57**

4-Light Pendant  
Polished Pewter Finish  
19-7/8"W x 21-3/4"H  
Adj H 21-3/4" - 78-3/4"  
4C 60W  
30° Swivel  
Crackled Glass  
Metal Candle Covers

**G. 7-201-4-322**

4-Light Pendant  
Warm Brass Finish  
19-7/8"W x 21-3/4"H  
Adj H 21-3/4" - 78-3/4"  
4C 60W  
30° Swivel  
Crackled Glass  
Metal Candle Covers

**H. 7-200-3-57**

3-Light Pendant  
Polished Pewter Finish  
12"W x 13"H  
Adj H 13"H - 70"  
3C 60W  
30° Swivel  
Crackled Glass  
Metal Candle Covers

\*\*Options: 7-EXTLG- Extension Rod - 12"

# MAGNUM



- |                                                                                                                                                |                                                                                                                                                    |                                                                                                                                                 |                                                                                                                                                |                                                                                                                                                    |                                                                                                                                                 |
|------------------------------------------------------------------------------------------------------------------------------------------------|----------------------------------------------------------------------------------------------------------------------------------------------------|-------------------------------------------------------------------------------------------------------------------------------------------------|------------------------------------------------------------------------------------------------------------------------------------------------|----------------------------------------------------------------------------------------------------------------------------------------------------|-------------------------------------------------------------------------------------------------------------------------------------------------|
| <p><b>A. 7-2137-3-89</b><br/>3-Light Pendant<br/>Matte Black Finish<br/>12-5/8"W x 28"H<br/>3C 60W<br/>Clear Glass<br/>Metal Candle Covers</p> | <p><b>B. 7-2137-3-11</b><br/>3-Light Pendant<br/>Polished Chrome Finish<br/>12-5/8"W x 28"H<br/>3C 60W<br/>Clear Glass<br/>Metal Candle Covers</p> | <p><b>C. 7-2137-3-127</b><br/>3-Light Pendant<br/>Noble Brass Finish<br/>12-5/8"W x 28"H<br/>3C 60W<br/>Clear Glass<br/>Metal Candle Covers</p> | <p><b>D. 7-2138-4-89</b><br/>4-Light Pendant<br/>Matte Black Finish<br/>15-7/8"W x 37"H<br/>4C 60W<br/>Clear Glass<br/>Metal Candle Covers</p> | <p><b>E. 7-2138-4-11</b><br/>4-Light Pendant<br/>Polished Chrome Finish<br/>15-7/8"W x 37"H<br/>4C 60W<br/>Clear Glass<br/>Metal Candle Covers</p> | <p><b>F. 7-2138-4-127</b><br/>4-Light Pendant<br/>Noble Brass Finish<br/>15-7/8"W x 37"H<br/>4C 60W<br/>Clear Glass<br/>Metal Candle Covers</p> |
|------------------------------------------------------------------------------------------------------------------------------------------------|----------------------------------------------------------------------------------------------------------------------------------------------------|-------------------------------------------------------------------------------------------------------------------------------------------------|------------------------------------------------------------------------------------------------------------------------------------------------|----------------------------------------------------------------------------------------------------------------------------------------------------|-------------------------------------------------------------------------------------------------------------------------------------------------|



# MAGNUM

A.



B.



C.



D.



E.



F.



# AKRON

---



A.



# AKRON

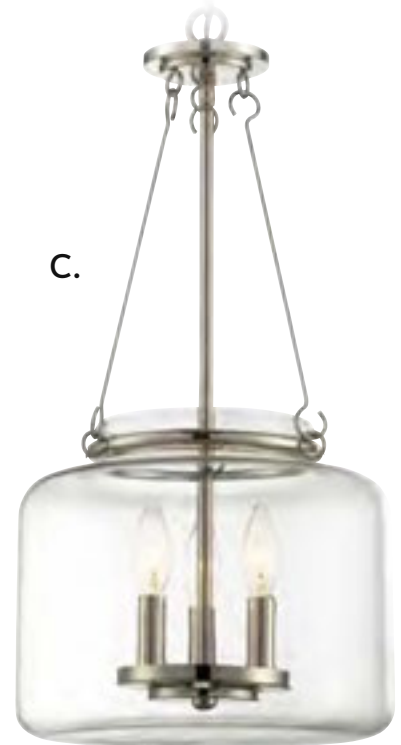
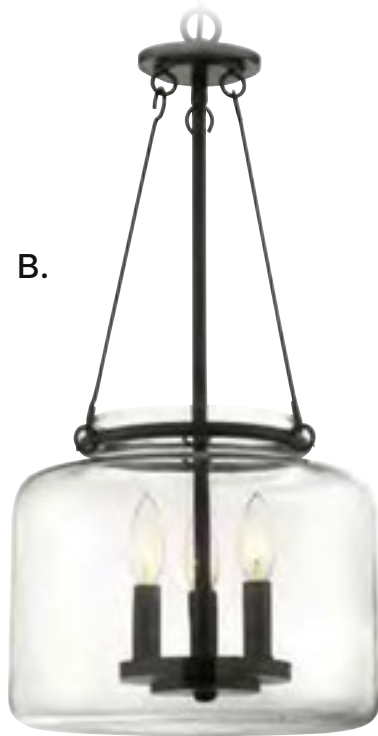

**A. 7-9006-3-89**  
3-Light Pendant  
Matte Black Finish  
12"W x 24"H  
3C 60W  
Clear Glass  
Metal Candle Covers

**B. 7-9006-3-13**  
3-Light Pendant  
English Bronze Finish  
12"W x 24"H  
3C 60W  
Clear Glass  
Metal Candle Covers

**C. 7-9006-3-109**  
3-Light Pendant  
Polished Nickel Finish  
12"W x 24"H  
3C 60W  
Clear Glass  
Metal Candle Covers

**D. 7-9006-3-SN**  
3-Light Pendant  
Satin Nickel Finish  
12"W x 24"H  
3C 60W  
Clear Glass  
Metal Candle Covers

**E. 7-9006-3-322**  
3-Light Pendant  
Warm Brass Finish  
12"W x 24"H  
3C 60W  
Clear Glass  
Metal Candle Covers

# DASH



A.



B.



C.



A. 6-2182-16-SN  
16" Flush Mount  
Satin Nickel Finish  
16"W x 6-3/4"H  
3E 60W  
Clear Seeded Glass

B. 6-2182-16-322  
16" Flush Mount  
Warm Brass Finish  
16"W x 6-3/4"H  
3E 60W  
Clear Seeded Glass

C. 6-2182-16-13  
16" Flush Mount  
English Bronze Finish  
16"W x 6-3/4"H  
3E 60W  
Clear Seeded Glass

# DASH



D.



E.



F.



H.



G.



I.

D. 6-2183-3-13  
3-Light Semi-Flush  
English Bronze Finish  
16"W x 13"H  
3E 60W  
Clear Seeded Glass

E. 6-2183-3-322  
3-Light Semi-Flush  
Warm Brass Finish  
16"W x 13"H  
3E 60W  
Clear Seeded Glass

F. 6-2183-3-SN  
3-Light Semi-Flush  
Satin Nickel Finish  
16"W x 13"H  
3E 60W  
Clear Seeded Glass

G. 7-2180-3-13  
3-Light Pendant  
English Bronze Finish  
18"W x 19"H  
3E 60W  
Clear Seeded Glass

H. 7-2180-3-322  
3-Light Pendant  
Warm Brass Finish  
18"W x 19"H  
3E 60W  
Clear Seeded Glass

I. 7-2180-3-SN  
3-Light Pendant  
Satin Nickel Finish  
18"W x 19"H  
3E 60W  
Clear Seeded Glass

# KENT



**A. 6-4900-4-322**  
 4-Light Semi-Flush  
 Warm Brass Finish  
 16"W x 14-3/4"H  
 4E 60W  
 Metal Candle  
 Covers

**B. 6-4900-4-89**  
 4-Light Semi-Flush  
 Matte Black Finish  
 16"W x 14-3/4"H  
 4E 60W  
 Metal Candle  
 Covers

**C. 6-4900-4-SN**  
 4-Light Semi-Flush  
 Satin Nickel Finish  
 16"W x 14-3/4"H  
 4E 60W  
 Metal Candle  
 Covers

**D. 3-4901-4-322**  
 4-Light Pendant  
 Warm Brass Finish  
 16"W x 24"H  
 Adj H 24"- 81"  
 4C 60W  
 30° Swivel  
 Metal Candle  
 Covers

**E. 3-4901-4-89**  
 4-Light Pendant  
 Matte Black Finish  
 16"W x 24"H  
 Adj H 24"- 81"  
 4C 60W  
 30° Swivel  
 Metal Candle  
 Covers

**F. 3-4901-4-SN**  
 4-Light Pendant  
 Satin Nickel Finish  
 16"W x 24"H  
 Adj H 24"- 81"  
 4C 60W  
 30° Swivel  
 Metal Candle  
 Covers

# KENT



A.



B.



C.



\*D.



\*E.



\*F.

\*Options: 7-EXT- Extension Rod - 9-1/2"

# GARRETT

A.



B.



C.

- A. **3-3055-4-13**  
4-Light Pendant  
English Bronze Finish  
12"W x 23"H  
4C 60W  
Clear Glass  
Metal Candle Covers
- B. **3-3056-4-13**  
4-Light Pendant  
English Bronze Finish  
15"W x 28-1/4"H  
4C 60W  
Clear Glass  
Metal Candle Covers
- C. **6-3058-4-13**  
12" Flush Mount  
English Bronze Finish  
12-3/8"W x 11"H  
4C 60W  
Clear Glass  
Metal Candle Covers





# GARRETT

D.



E.



F.

D. **3-3056-4-109**  
4-Light Pendant  
Polished Nickel Finish  
15"W x 28-1/4"H  
4C 60W  
Clear Glass  
Metal Candle Covers

E. **3-3055-4-109**  
4-Light Pendant  
Polished Nickel Finish  
12"W x 23"H  
4C 60W  
Clear Glass  
Metal Candle Covers

F. **6-3058-4-109**  
12" Flush Mount  
Polished Nickel Finish  
12-3/8"W x 11"H  
4C 60W  
Clear Glass  
Metal Candle Covers

# PENROSE



A.



B.



C.



D.



E.



F.

**A. 6-1043-3-13**

3-Light Semi-Flush  
English Bronze Finish  
12-1/2"W x 14"H  
3C 60W  
Clear Glass  
Metal Candle Covers

**B. 6-1043-3-109**

3-Light Semi-Flush  
Polished Nickel Finish  
12-1/2"W x 14"H  
3C 60W  
Clear Glass  
Metal Candle Covers

**C. 6-1043-3-BK**

3-Light Semi-Flush  
Matte Black Finish  
12-1/2"W x 14"H  
3C 60W  
Clear Glass  
Metal Candle Covers

**D. 7-1040-3-13**

3-Light Foyer  
English Bronze Finish  
12"W x 26"H  
3C 60W  
Clear Glass  
Metal Candle Covers

**E. 7-1040-3-109**

3-Light Foyer  
Polished Nickel Finish  
12"W x 26"H  
3C 60W  
Clear Glass  
Metal Candle Covers

**F. 7-1040-3-BK**

3-Light Foyer  
Matte Black Finish  
12"W x 26"H  
3C 60W  
Clear Glass  
Metal Candle Covers

# PENROSE



G.



H.



G. 6-1043-3-SN  
3-Light Semi-Flush  
Satin Nickel Finish  
12-1/2"W x 14"H  
3C 60W  
Clear Glass  
Metal Candle Covers

H. 7-1040-3-SN  
3-Light Foyer  
Satin Nickel Finish  
12"W x 26"H  
3C 60W  
Clear Glass  
Metal Candle Covers

# PENROSE

---



**A. 7-1041-6-109**  
6-Light Foyer  
Polished Nickel Finish  
16"W x 34"H  
6C 60W  
Clear Glass  
Metal Candle Covers

# PENROSE



B.

**B. 7-1041-6-BK**  
6-Light Foyer  
Matte Black Finish  
16"W x 34"H  
6C 60W  
Clear Glass  
Metal Candle Covers



C.

**C. 7-1041-6-SN**  
6-Light Foyer  
Satin Nickel Finish  
16"W x 34"H  
6C 60W  
Clear Glass  
Metal Candle Covers



D.

**D. 7-1041-6-13**  
6-Light Foyer  
English Bronze Finish  
16"W x 34"H  
6C 60W  
Clear Glass  
Metal Candle Covers

# ALDEN



- A. 7-131-1-109**  
1-Light Pendant  
Polished Nickel Finish  
18-1/4"W x 12-1/2"H  
Adj H 12-1/2" - 33-3/4"  
1E 60W
- B. 7-132-1-109**  
1-Light Pendant  
Polished Nickel Finish  
12"W x 8-1/2"H  
Adj H 8-1/2" - 30"  
1E 60W
- C. 7-131-1-323**  
1-Light Pendant  
Old Bronze Finish  
18-1/4"W x 12-1/2"H  
Adj H 12-1/2" - 33-3/4"  
1E 60W
- D. 7-132-1-323**  
1-Light Pendant  
Old Bronze Finish  
12"W x 8-1/2"H  
Adj H 8-1/2" - 30"  
1E 60W
- E. 7-131-1-322**  
1-Light Pendant  
Warm Brass Finish  
18-1/4"W x 12-1/2"H  
Adj H 12-1/2" - 33-3/4"  
1E 60W
- F. 7-132-1-322**  
1-Light Pendant  
Warm Brass Finish  
12"W x 8-1/2"H  
Adj H 8-1/2" - 30"  
1E 60W
- G. 7-131-1-89**  
1-Light Pendant  
Matte Black Finish  
18-1/4"W x 12-1/2"H  
Adj H 12-1/2" - 33-3/4"  
1E 60W
- H. 7-132-1-89**  
1-Light Pendant  
Matte Black Finish  
12"W x 8-1/2"H  
Adj H 8-1/2" - 30"  
1E 60W

# ALDEN



Pendants come with two sections of decorative linked stems, plus chain.

# AUSTIN

---





# AUSTIN



A.

A. 7-2201-4-13  
4-Light Pendant  
English Bronze Finish  
18"W x 32-1/2"H  
4C 60W  
White Fabric Shade



B.

B. 7-2201-4-SN  
4-Light Pendant  
Satin Nickel Finish  
18"W x 32-1/2"H  
4C 60W  
White Fabric Shade



C.

C. 7-2201-4-322  
4-Light Pendant  
Warm Brass Finish  
18"W x 32-1/2"H  
4C 60W  
White Fabric Shade

# ASHMONT

---



Options: 7-EXT- Extension Rod - 9-1/2"

# ASHMONT



**A. 7-130-1-109**  
1-Light Pendant  
Polished Nickel Finish  
13"W x 21-1/4"H  
Adj H 21-1/4" - 49-3/4"  
1E 60W  
90° Swivel  
White Opal Glass

**B. 7-130-1-44**  
1-Light Pendant  
Classic Bronze Finish  
13"W x 21-1/4"H  
Adj H 21-1/4" - 49-3/4"  
1E 60W  
90° Swivel  
White Opal Glass

**C. 7-130-1-63**  
1-Light Pendant  
Warm Brass Lustre Finish  
13"W x 21-1/4"H  
Adj H 21-1/4" - 49-3/4"  
1E 60W  
90° Swivel  
White Opal Glass

**D. 7-130-1-SN**  
1-Light Pendant  
Satin Nickel Finish  
13"W x 21-1/4"H  
Adj H 21-1/4" - 49-3/4"  
1E 60W  
90° Swivel  
White Opal Glass

# BERG



**A. 6-3750-1-109**  
1-Light Semi-Flush  
Polished Nickel Finish  
12"W x 12"H  
1E 60W

**B. 6-3750-1-89**  
1-Light Semi-Flush  
Matte Black Finish  
12"W x 12"H  
1E 60W

**C. 7-3751-1-109**  
1-Light Pendant  
Polished Nickel Finish  
12"W x 14"H  
Adj H 14"- 45-1/2"  
1E 60W  
90° Swivel

**D. 7-3751-1-89**  
1-Light Pendant  
Matte Black Finish  
12"W x 14"H  
Adj H 14"- 45-1/2"  
1E 60W  
90° Swivel



**E. 6-3750-1-SN**  
1-Light Semi-Flush  
Satin Nickel Finish  
12"W x 12"H  
1E 60W

**F. 6-3750-1-322**  
1-Light Semi-Flush  
Warm Brass Finish  
12"W x 12"H  
1E 60W

**G. 6-3750-1-13**  
1-Light Semi-Flush  
English Bronze Finish  
12"W x 12"H  
1E 60W

**H. 7-3751-1-SN**  
1-Light Pendant  
Satin Nickel Finish  
12"W x 14"H  
Adj H 14"- 45-1/2"  
1E 60W  
90° Swivel

**I. 7-3751-1-322**  
1-Light Pendant  
Warm Brass Finish  
12"W x 14"H  
Adj H 14"- 45-1/2"  
1E 60W  
90° Swivel

**J. 7-3751-1-13**  
1-Light Pendant  
English Bronze Finish  
12"W x 14"H  
Adj H 14"- 45-1/2"  
1E 60W  
90° Swivel

\*Options: 7-EXT- Extension Rod - 9-1/2"

# PENDLETON



**A. 6-7200-1-89**  
 1-Light Semi-Flush  
 Matte Black Finish  
 9-3/8"W x 9-3/4"H  
 1E 60W  
 Clear Glass

**B. 6-7200-1-11**  
 1-Light Semi-Flush  
 Polished Chrome Finish  
 9-3/8"W x 9-3/4"H  
 1E 60W  
 Clear Glass

**C. 7-7201-1-89**  
 1-Light Pendant  
 Matte Black Finish  
 14"W x 14"H  
 Adj H 14"- 45-1/2"  
 1E 60W  
 90° Swivel  
 Clear Glass

**D. 7-7201-1-11**  
 1-Light Pendant  
 Polished Chrome Finish  
 14"W x 14"H  
 Adj H 14"- 45-1/2"  
 1E 60W  
 90° Swivel  
 Clear Glass

\*Options: 7-EXT- Extension Rod - 9-1/2"

# PENDLETON



**E. 6-7200-1-322**  
 1-Light Semi-Flush  
 Warm Brass Finish  
 9-3/8"W x 9-3/4"H  
 1E 60W  
 Clear Glass

**F. 6-7200-1-SN**  
 1-Light Semi-Flush  
 Satin Nickel Finish  
 9-3/8"W x 9-3/4"H  
 1E 60W  
 Clear Glass

**G. 7-7201-1-322**  
 1-Light Pendant  
 Warm Brass Finish  
 14"W x 14"H  
 Adj H 14"- 45-1/2"  
 1E 60W  
 90° Swivel  
 Clear Glass

**H. 7-7201-1-SN**  
 1-Light Pendant  
 Satin Nickel Finish  
 14"W x 14"H  
 Adj H 14"- 45-1/2"  
 1E 60W  
 90° Swivel  
 Clear Glass

\*Options: 7-EXT- Extension Rod - 9-1/2"

# SHANE

---

A.



B.



C.



D.





# SHANE



**A. 1-2070-1-109**  
1-Light Pendant  
Polished Nickel Finish  
16"W x 12"H  
1E 60W  
Clear Glass

**B. 1-2070-1-13**  
1-Light Pendant  
English Bronze Finish  
16"W x 12"H  
1E 60W  
Clear Glass

**C. 1-2070-1-322**  
1-Light Pendant  
Warm Brass Finish  
16"W x 12"H  
1E 60W  
Clear Glass

**D. 1-2070-1-SN**  
1-Light Pendant  
Satin Nickel Finish  
16"W x 12"H  
1E 60W  
Clear Glass

# GARVEY

\*A.



\*B.



\*C.



**A. 7-5012-1-322**  
 1-Light Pendant  
 Warm Brass Finish  
 14"W x 16-1/2"H  
 Adj H 16-1/2" - 48"  
 1E 60W  
 90° Swivel  
 Clear Glass

**B. 7-5012-1-13**  
 1-Light Pendant  
 English Bronze Finish  
 14"W x 16-1/2"H  
 Adj H 16-1/2" - 48"  
 1E 60W  
 90° Swivel  
 Clear Glass

**C. 7-5012-1-109**  
 1-Light Pendant  
 Polished Nickel Finish  
 14"W x 16-1/2"H  
 Adj H 16-1/2" - 48"  
 1E 60W  
 90° Swivel  
 Clear Glass

\*Options: 7-EXT- Extension Rod - 9-1/2"

# MAYFIELD

D. 7-17000-1-109  
1-Light Pendant  
Polished Nickel Finish  
15-1/2"W x 13"H  
1E 60W  
Clear Glass

E. 7-17000-1-13  
1-Light Pendant  
English Bronze Finish  
15-1/2"W x 13"H  
1E 60W  
Clear Glass

F. 7-17000-1-322  
1-Light Pendant  
Warm Brass Finish  
15-1/2"W x 13"H  
1E 60W  
Clear Glass

D.



E.



F.



# DRAKE



**A. 7-9132-1-109**  
 1-Light Pendant  
 Polished Nickel Finish  
 10"W x 11-1/2"H  
 Adj H 11-1/2" - 43"  
 1E 60W  
 90° Swivel  
 Clear Glass

**B. 7-9132-1-13**  
 1-Light Pendant  
 English Bronze Finish  
 10"W x 11-1/2"H  
 Adj H 11-1/2" - 43"  
 1E 60W  
 90° Swivel  
 Clear Glass

**C. 7-9132-1-322**  
 1-Light Pendant  
 Warm Brass Finish  
 10"W x 11-1/2"H  
 Adj H 11-1/2" - 43"  
 1E 60W  
 90° Swivel  
 Clear Glass

**D. 7-9132-1-SN**  
 1-Light Pendant  
 Satin Nickel Finish  
 10"W x 11-1/2"H  
 Adj H 11-1/2" - 43"  
 1E 60W  
 90° Swivel  
 Clear Glass

**Options: 7-EXT-** Extension Rod - 9-1/2"

# OCTAVE



E.



F.



G.



H.



I.



**E. 7-4036-1-SN**  
1-Light Mini-Pendant  
Satin Nickel Finish  
8-1/2"W x 10-1/2"H  
Adj H 10-1/2" - 42"  
1E 60W  
90° Swivel  
Clear Glass

**F. 7-4036-1-BK**  
1-Light Mini-Pendant  
Matte Black Finish  
8-1/2"W x 10-1/2"H  
Adj H 10-1/2" - 42"  
1E 60W  
90° Swivel  
Clear Glass

**G. 7-4036-1-11**  
1-Light Mini-Pendant  
Polished Chrome Finish  
8-1/2"W x 10-1/2"H  
Adj H 10-1/2" - 42"  
1E 60W  
90° Swivel  
Clear Glass

**H. 7-4036-1-322**  
1-Light Mini-Pendant  
Warm Brass Finish  
8-1/2"W x 10-1/2"H  
Adj H 10-1/2" - 42"  
1E 60W  
90° Swivel  
Clear Glass

**I. 7-4036-1-13**  
1-Light Mini-Pendant  
English Bronze Finish  
8-1/2"W x 10-1/2"H  
Adj H 10-1/2" - 42"  
1E 60W  
90° Swivel  
Clear Glass

**Options: 7-EXT-** Extension Rod - 9-1/2"

# FRANKLIN



**A. 7-702-1-13**  
1-Light Pendant  
English Bronze Finish  
10"W x 20"H  
1E 60W  
Clear Glass

**B. 7-703-1-SN**  
1-Light Pendant  
Satin Nickel Finish  
10"W x 20"H  
1E 60W  
Silver Mercury Glass

**C. 7-702-1-109**  
1-Light Pendant  
Polished Nickel Finish  
10"W x 20"H  
1E 60W  
Clear Glass

# BALLY

- D. **7-700-1-109**  
1-Light Mini-Pendant  
Polished Nickel Finish  
6-1/2"W x 12"H  
1E 60W  
Clear Glass
- E. **7-701-1-SN**  
1-Light Mini-Pendant  
Satin Nickel Finish  
6-1/2"W x 12"H  
1E 60W  
Silver Mercury Glass
- F. **7-700-1-13**  
1-Light Mini-Pendant  
English Bronze Finish  
6-1/2"W x 12"H  
1E 60W  
Clear Glass



D.



E.



F.



# AVALON

---

A.



B.



C.



D.



E.





# AVALON



**A. 6-7790-3-SN**  
3-Light Semi-Flush  
Satin Nickel Finish  
11-3/8"W x 12-1/4"H  
3C 60W  
Crackled Glass  
Metal Candle Covers

**B. 6-7790-3-89**  
3-Light Semi-Flush  
Matte Black Finish  
11-3/8"W x 12-1/4"H  
3C 60W  
Crackled Glass  
Metal Candle Covers

**C. 6-7790-3-13**  
3-Light Semi-Flush  
English Bronze Finish  
11-3/8"W x 12-1/4"H  
3C 60W  
Crackled Glass  
Metal Candle Covers

**D. 6-7790-3-322**  
3-Light Semi-Flush  
Warm Brass Finish  
11-3/8"W x 12-1/4"H  
3C 60W  
Crackled Glass  
Metal Candle Covers

**E. 6-7790-3-109**  
3-Light Semi-Flush  
Polished Nickel Finish  
11-3/8"W x 12-1/4"H  
3C 60W  
Crackled Glass  
Metal Candle Covers

# WALPOLE

---

A.



B.



C.



D.



E.



# WALPOLE



**A. 6-9137-1-322**  
1-Light Semi-Flush  
Warm Brass Finish  
11"W x 11-1/2"H  
1E 60W  
Clear Glass

**B. 6-9137-1-109**  
1-Light Semi-Flush  
Polished Nickel Finish  
11"W x 11-1/2"H  
1E 60W  
Clear Glass

**C. 6-9137-1-89**  
1-Light Semi-Flush  
Matte Black Finish  
11"W x 11-1/2"H  
1E 60W  
Clear Glass

**D. 6-9137-1-13**  
1-Light Semi-Flush  
English Bronze Finish  
11"W x 11-1/2"H  
1E 60W  
Clear Glass

**E. 6-9137-1-SN**  
1-Light Semi-Flush  
Satin Nickel Finish  
11"W x 11-1/2"H  
1E 60W  
Clear Glass

# OCTAVE

A.



B.



C.



A. 6-4037-1-SN

1-Light Semi-Flush  
Satin Nickel Finish  
8"W x 14"H  
1E 60W  
Clear Glass

B. 6-4037-1-BK

1-Light Semi-Flush  
Matte Black Finish  
8"W x 14"H  
1E 60W  
Clear Glass

C. 6-4037-1-11

1-Light Semi-Flush  
Polished Chrome Finish  
8"W x 14"H  
1E 60W  
Clear Glass

D. 6-4037-1-322

1-Light Semi-Flush  
Warm Brass Finish  
8"W x 14"H  
1E 60W  
Clear Glass

E. 6-4037-1-13

1-Light Semi-Flush  
English Bronze Finish  
8"W x 14"H  
1E 60W  
Clear Glass

D.



E.



# OCTAVE

- F. **6-4035-3-SN**  
3-Light Semi-Flush  
Satin Nickel Finish  
13"W x 11"H  
3E 60W  
Clear Glass
- G. **6-4035-3-BK**  
3-Light Semi-Flush  
Matte Black Finish  
13"W x 11"H  
3E 60W  
Clear Glass
- H. **6-4035-3-11**  
3-Light Semi-Flush  
Polished Chrome Finish  
13"W x 11"H  
3E 60W  
Clear Glass
- I. **6-4035-3-13**  
3-Light Semi-Flush  
English Bronze Finish  
13"W x 11"H  
3E 60W  
Clear Glass
- J. **6-4035-3-322**  
3-Light Semi-Flush  
Warm Brass Finish  
13"W x 11"H  
3E 60W  
Clear Glass



F.



G.



H.



I.



J.



# SHERRILL

LED



A.



B.



C.



D.

**A. 6-2390-14-SN**

LED Flush Mount  
Satin Nickel Finish  
14"W x 5-1/2"H  
20W LED Dimmable – 1050 Lumens,  
3000K, 90 CRI  
Etched Glass

**B. 6-2390-14-322**

LED Flush Mount  
Warm Brass Finish  
14"W x 5-1/2"H  
20W LED Dimmable – 1050 Lumens,  
3000K, 90 CRI  
Etched Glass

**C. 6-2390-14-89**

LED Flush Mount  
Matte Black Finish  
14"W x 5-1/2"H  
20W LED Dimmable – 1050 Lumens,  
3000K, 90 CR  
Etched Glass

**D. 6-2390-14-109**

LED Flush Mount  
Polished Nickel Finish  
14"W x 5-1/2"H  
20W LED Dimmable – 1050 Lumens,  
3000K, 90 CRI  
Etched Glass

# LACEY



E.



F.



G.



E. 6-2706-3-322  
16" Flush Mount  
Warm Brass Finish  
16"W x 8-1/2"H  
3E 60W  
White Fabric Shade

F. 6-2706-3-109  
16" Flush Mount  
Polished Nickel Finish  
16"W x 8-1/2"H  
3E 60W  
White Fabric Shade

G. 6-2706-3-44  
16" Flush Mount  
Classic Bronze Finish  
16"W x 8-1/2"H  
3E 60W  
White Fabric Shade

# WATKINS



- |                                                                                                              |                                                                                                                 |                                                                                                                   |                                                                                                            |                                                                                                               |                                                                                                                 |
|--------------------------------------------------------------------------------------------------------------|-----------------------------------------------------------------------------------------------------------------|-------------------------------------------------------------------------------------------------------------------|------------------------------------------------------------------------------------------------------------|---------------------------------------------------------------------------------------------------------------|-----------------------------------------------------------------------------------------------------------------|
| <b>A. 6-134-3-322</b><br>3-Light Semi-Flush<br>Warm Brass Finish<br>16"W x 9"H<br>3E 60W<br>White Opal Glass | <b>B. 6-134-3-44</b><br>3-Light Semi-Flush<br>Classic Bronze Finish<br>16"W x 9"H<br>3E 60W<br>White Opal Glass | <b>C. 6-134-3-109</b><br>3-Light Semi-Flush<br>Polished Nickel Finish<br>16"W x 9"H<br>3E 60W<br>White Opal Glass | <b>D. 6-133-16-322</b><br>16" Flush Mount<br>Warm Brass Finish<br>16"W x 4"H<br>3E 60W<br>White Opal Glass | <b>E. 6-133-16-44</b><br>16" Flush Mount<br>Classic Bronze Finish<br>16"W x 4"H<br>3E 60W<br>White Opal Glass | <b>F. 6-133-16-109</b><br>16" Flush Mount<br>Polished Nickel Finish<br>16"W x 4"H<br>3E 60W<br>White Opal Glass |
|--------------------------------------------------------------------------------------------------------------|-----------------------------------------------------------------------------------------------------------------|-------------------------------------------------------------------------------------------------------------------|------------------------------------------------------------------------------------------------------------|---------------------------------------------------------------------------------------------------------------|-----------------------------------------------------------------------------------------------------------------|



A.



B.



C.



D.



E.



F.



# ABERDEEN



A.



B.



C.



**A 6-150-14-109**  
14" Flush Mount  
Polished Nickel Finish  
14"W x 8-1/4"H  
2E 60W  
Clear Ribbed Glass

**B. 6-150-14-44**  
14" Flush Mount  
Classic Bronze Finish  
14"W x 8-1/4"H  
2E 60W  
Clear Ribbed Glass

**C. 6-150-14-SN**  
14" Flush Mount  
Satin Nickel Finish  
14"W x 8-1/4"H  
2E 60W  
Clear Ribbed Glass

# BENTON



D.



E.



F.



G.

D. **6-9069-13-SN**  
13" Flush Mount  
Satin Nickel Finish  
13"W x 5-1/8"H  
2E 60W  
Clear Halophane Glass

E. **6-9069-13-13**  
13" Flush Mount  
English Bronze Finish  
13"W x 5-1/8"H  
2E 60W  
Clear Halophane Glass

F. **6-9069-13-322**  
13" Flush Mount  
Warm Brass Finish  
13"W x 5-1/8"H  
2E 60W  
Clear Halophane Glass

G. **6-9069-13-109**  
13" Flush Mount  
Polished Nickel Finish  
13"W x 5-1/8"H  
2E 60W  
Clear Halophane Glass

# LUCERNE



A.



B.



C.



D.



E.



F.



G.



H.

- |    |                 |    |                 |    |                 |    |                 |    |                   |    |                   |    |                     |    |                     |
|----|-----------------|----|-----------------|----|-----------------|----|-----------------|----|-------------------|----|-------------------|----|---------------------|----|---------------------|
| A. | 6-3350-16-109   | B. | 6-3350-14-109   | C. | 6-3350-16-13    | D. | 6-3350-14-13    | E. | 6-3350-16-322     | F. | 6-3350-14-322     | G. | 6-3350-16-SN        | H. | 6-3350-14-SN        |
|    | 15" Flush Mount |    | 13" Flush Mount |    | 15" Flush Mount |    | 13" Flush Mount |    | 15" Flush Mount   |    | 13" Flush Mount   |    | 15" Flush Mount     |    | 13" Flush Mount     |
|    | Polished Nickel |    | Polished Nickel |    | English Bronze  |    | English Bronze  |    | Warm Brass Finish |    | Warm Brass Finish |    | Satin Nickel Finish |    | Satin Nickel Finish |
|    | Finish          |    | Finish          |    | Finish          |    | Finish          |    | 15"W x 4-3/4"H    |    | 13-1/4"W x        |    | 15"W x 4-3/4"H      |    | 13-1/4"W x          |
|    | 15"W x 4-3/4"H  |    | 13-1/4"W x      |    | 15"W x 4-3/4"H  |    | 13-1/4"W x      |    | 3E 60W            |    | 4-3/4"H           |    | 3E 60W              |    | 4-3/4"H             |
|    | 3E 60W          |    | 4-3/4"H         |    | 3E 60W          |    | 4-3/4"H         |    | White Glass       |    | 2E 60W            |    | White Glass         |    | 2E 60W              |
|    | White Glass     |    | 2E 60W          |    | White Glass     |    | 2E 60W          |    |                   |    | White Glass       |    |                     |    | White Glass         |
|    |                 |    | White Class     |    |                 |    | White Class     |    |                   |    |                   |    |                     |    |                     |

# LUCERNE



I.



J.



K.



L.



M.



N.

I. 6-3351-3-13  
3-Light Semi-Flush  
English Bronze Finish  
18-1/2"W x 13-1/2"H  
3E 60W  
White Glass

J. 6-3352-2-13  
2-Light Semi-Flush  
English Bronze Finish  
16-1/2"W x 10-3/4"H  
2E 60W  
White Glass

K. 6-3351-3-322  
3-Light Semi-Flush  
Warm Brass Finish  
18-1/2"W x 13-1/2"H  
3E 60W  
White Glass

L. 6-3352-2-322  
2-Light Semi-Flush  
Warm Brass Finish  
16-1/2"W x 10-3/4"H  
2E 60W  
White Glass

M. 6-3351-3-SN  
3-Light Semi-Flush  
Satin Nickel Finish  
18-1/2"W x 13-1/2"H  
3E 60W  
White Glass

N. 6-3352-2-SN  
2-Light Semi-Flush  
Satin Nickel Finish  
16-1/2"W x 10-3/4"H  
2E 60W  
White Glass

# CEILING

---



**A. 6-780-13-BK**  
13" Flush Mount  
Matte Black Finish  
13"W x 5"H  
2E 60W  
White Etched Glass

**B. 6-780-11-BK**  
11" Flush Mount  
Matte Black Finish  
11"W x 4-1/2"H  
2E 40W  
White Etched Glass



**A.**



**B.**

# CEILING



C.



D.

C. **6-780-11-SN**  
11" Flush Mount  
Satin Nickel Finish  
11"W x 4-1/2"H  
2E 40W  
White Etched Glass

D. **6-780-13-SN**  
13" Flush Mount  
Satin Nickel Finish  
13"W x 5"H  
2E 60W  
White Etched Glass



E.



F.

E. **6-780-13-322**  
13" Flush Mount  
Warm Brass Finish  
13"W x 5"H  
2E 60W  
White Etched Glass

F. **6-780-11-322**  
11" Flush Mount  
Warm Brass Finish  
11"W x 4-1/2"H  
2E 40W  
White Etched Glass



G.



H.

G. **6-780-11-13**  
11" Flush Mount  
English Bronze Finish  
11"W x 4-1/2"H  
2E 40W  
White Etched Glass

H. **6-780-13-13**  
13" Flush Mount  
English Bronze Finish  
13"W x 5"H  
2E 60W  
White Etched Glass



I.



J.

I. **6-780-13-109**  
13" Flush Mount  
Polished Nickel Finish  
13"W x 5"H  
2E 60W  
White Etched Glass

J. **6-780-11-109**  
11" Flush Mount  
Polished Nickel Finish  
11"W x 4-1/2"H  
2E 40W  
White Etched Glass

# RUTLAND



A.



B.



C.



D.



E.

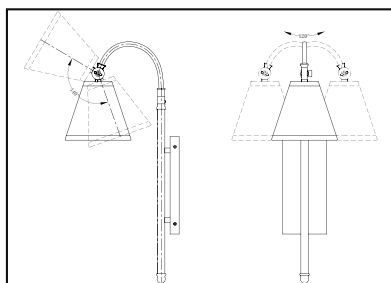



# RUTLAND



**A. 9-1201-1-109**  
1-Light Adjustable Sconce  
Polished Nickel Finish  
6-1/4"W x 24-1/2"H x 11-1/2"E  
1E 60W  
White Fabric Shade

**B. 9-1201-1-89**  
1-Light Adjustable Sconce  
Matte Black Finish  
6-1/4"W x 24-1/2"H x 11-1/2"E  
1E 60W  
White Fabric Shade

**C. 9-1201-1-322**  
1-Light Adjustable Sconce  
Warm Brass Finish  
6-1/4"W x 24-1/2"H x 11-1/2"E  
1E 60W  
White Fabric Shade

**D. 9-1201-1-44**  
1-Light Adjustable Sconce  
Classic Bronze Finish  
6-1/4"W x 24-1/2"H x 11-1/2"E  
1E 60W  
White Fabric Shade

**E. 9-1201-1-SN**  
1-Light Adjustable Sconce  
Satin Nickel Finish  
6-1/4"W x 24-1/2"H x 11-1/2"E  
1E 60W  
White Fabric Shade

# WAVERLY



**A. 9-1200-1-SN**  
1-Light Sconce  
Satin Nickel Finish  
5"W x 11"H x 6-1/2"E  
1C 60W  
White Fabric Shade  
Metal Candle Cover

**B. 9-1200-1-89**  
1-Light Sconce  
Matte Black Finish  
5"W x 11"H x 6-1/2"E  
1C 60W  
White Fabric Shade  
Metal Candle Cover

**C. 9-1200-1-322**  
1-Light Sconce  
Warm Brass Finish  
5"W x 11"H x 6-1/2"E  
1C 60W  
White Fabric Shade  
Metal Candle Cover

**D. 9-1200-1-13**  
1-Light Sconce  
English Bronze Finish  
5"W x 11"H x 6-1/2"E  
1C 60W  
White Fabric Shade  
Metal Candle Cover

**E. 9-1200-1-109**  
1-Light Sconce  
Polished Nickel Finish  
5"W x 11"H x 6-1/2"E  
1C 60W  
White Fabric Shade  
Metal Candle Cover

# WAVERLY

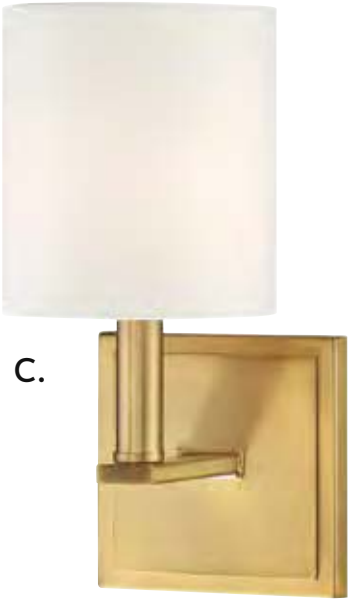

# MONROE

---



# MONROE

**A. 9-302-1-SN**  
1-Light Sconce  
Satin Nickel Finish  
5"W x 20"H x 6"E  
1C 60W  
White Fabric Shade  
Metal Candle Cover

**B. 9-303-1-SN**  
1-Light Sconce  
Satin Nickel Finish  
5"W x 24"H x 6-1/2"E  
1C 60W  
White Fabric Shade  
Metal Candle Cover

**C. 9-7144-1-SN**  
1-Light Sconce  
Satin Nickel Finish  
6-3/4"W x 33-1/2"H x 8"E  
1C 60W  
White Fabric Shade  
Metal Candle Cover

**D. 9-7144-1-89**  
1-Light Sconce  
Matte Black Finish  
6-3/4"W x 33-1/2"H x 8"E  
1C 60W  
White Fabric Shade  
Metal Candle Cover

**E. 9-303-1-89**  
1-Light Sconce  
Matte Black Finish  
5"W x 24"H x 6-1/2"E  
1C 60W  
White Fabric Shade  
Metal Candle Cover

**F. 9-302-1-89**  
1-Light Sconce  
Matte Black Finish  
5"W x 20"H x 6"E  
1C 60W  
White Fabric Shade  
Metal Candle Cover

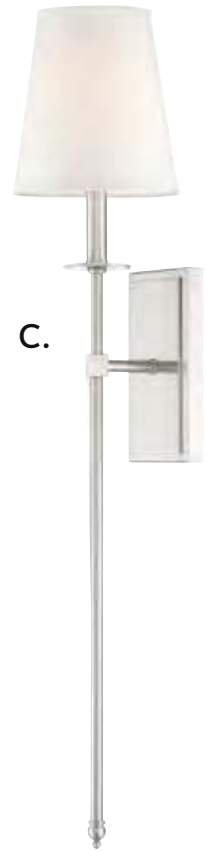
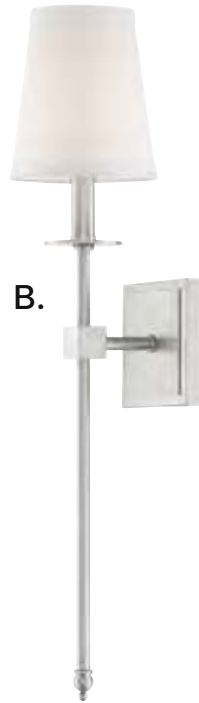
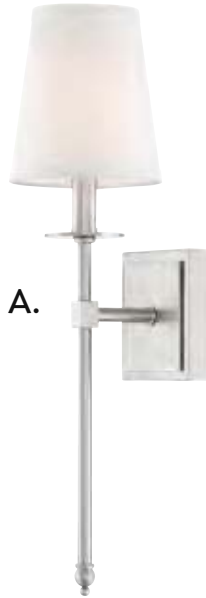

# MONROE



A.



B.



C.

**A. 9-7144-1-322**  
 1-Light Sconce  
 Warm Brass Finish  
 6-3/4\"/>

**B. 9-303-1-322**  
 1-Light Sconce  
 Warm Brass Finish  
 5\"/>

**C. 9-302-1-322**  
 1-Light Sconce  
 Warm Brass Finish  
 5\"/>

**D. 9-302-1-44**  
 1-Light Sconce  
 Classic Bronze Finish  
 5\"/>

**E. 9-303-1-44**  
 1-Light Sconce  
 Classic Bronze Finish  
 5\"/>

**F. 9-7144-1-44**  
 1-Light Sconce  
 Classic Bronze Finish  
 6-3/4\"/>

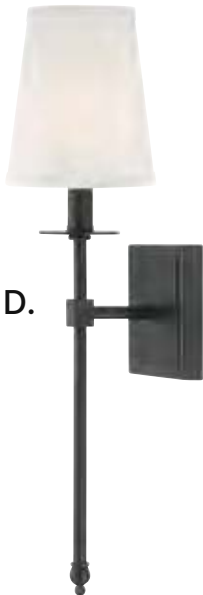

D.

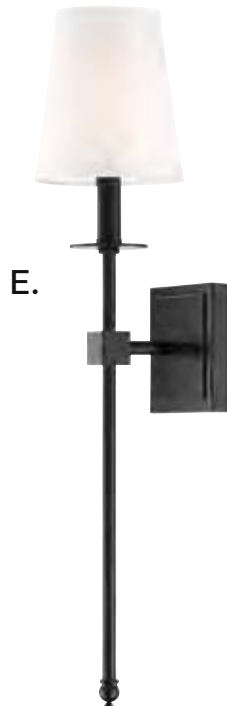

E.



F.

# MONROE



**G. 9-7144-1-109**  
1-Light Sconce  
Polished Nickel Finish  
6-3/4"W x 33-1/2"H x 8"E  
1C 60W  
White Fabric Shade  
Metal Candle Cover

**H. 9-303-1-109**  
1-Light Sconce  
Polished Nickel Finish  
5"W x 24"H x 6-1/2"E  
1C 60W  
White Fabric Shade  
Metal Candle Cover

**I. 9-302-1-109**  
1-Light Sconce  
Polished Nickel Finish  
5"W x 20"H x 6"E  
1C 60W  
White Fabric Shade  
Metal Candle Cover



# DESTIN

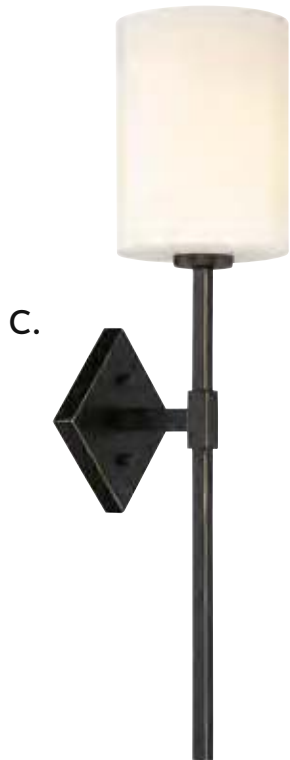

**A. 9-0902-1-322**  
1-Light Sconce  
Warm Brass Finish  
6"W x 22"H x 7"E  
1C 60W  
White Opal Glass

**B. 9-0902-1-89**  
1-Light Sconce  
Matte Black Finish  
6"W x 22"H x 7"E  
1C 60W  
White Opal Glass

**C. 9-0902-1-44**  
1-Light Sconce  
Classic Bronze Finish  
6"W x 22"H x 7"E  
1C 60W  
White Opal Glass

**D. 9-0902-1-109**  
1-Light Sconce  
Polished Nickel Finish  
6"W x 22"H x 7"E  
1C 60W  
White Opal Glass





# CHAPLIN



**E. 9-1000-1-109**  
 1-Light Sconce  
 Polished Nickel Finish  
 7"W x 26"H x 8-1/2"E  
 1C 60W  
 White Fabric Shade  
 Metal Candle Cover

**F. 9-1000-1-13**  
 1-Light Sconce  
 English Bronze Finish  
 7"W x 26"H x 8-1/2"E  
 1C 60W  
 White Fabric Shade  
 Metal Candle Cover



**E.**



**F.**



**G.**



**H.**

**G. 9-1000-1-322**  
 1-Light Sconce  
 Warm Brass Finish  
 7"W x 26"H x 8-1/2"E  
 1C 60W  
 White Fabric Shade  
 Metal Candle Cover

**H. 9-1000-1-SN**  
 1-Light Sconce  
 Satin Nickel Finish  
 7"W x 26"H x 8-1/2"E  
 1C 60W  
 White Fabric Shade  
 Metal Candle Cover

# PAYTON

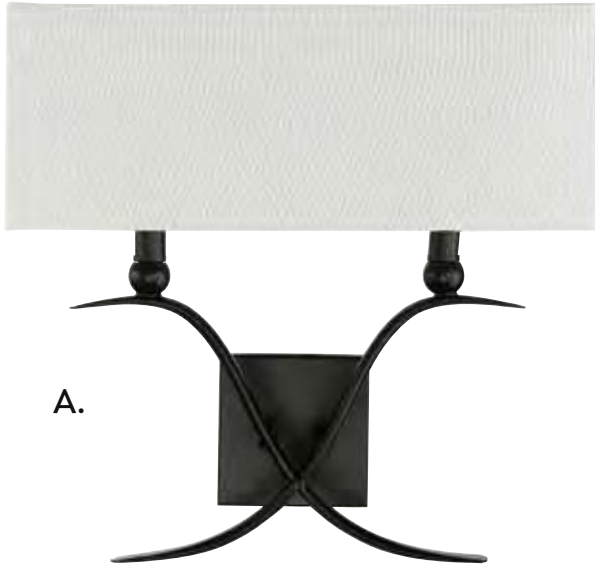

A.

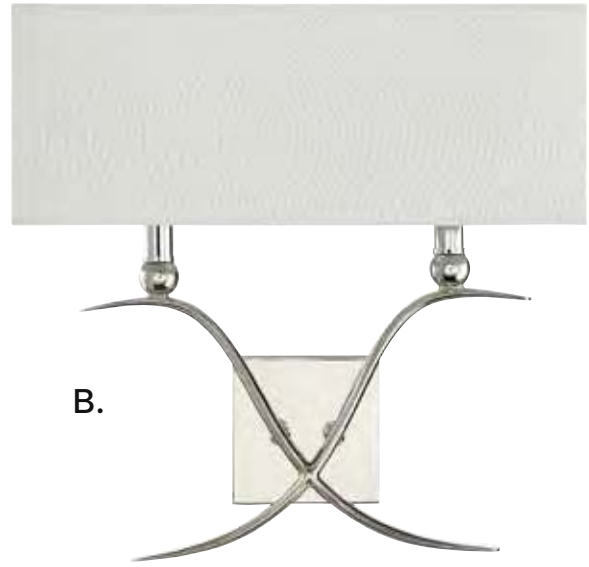

B.

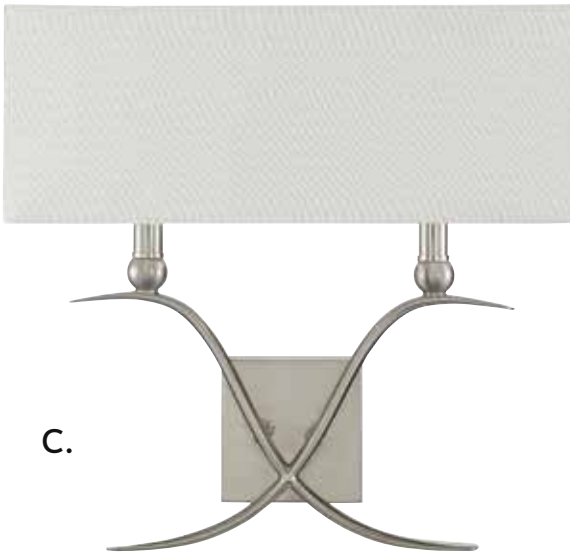

C.

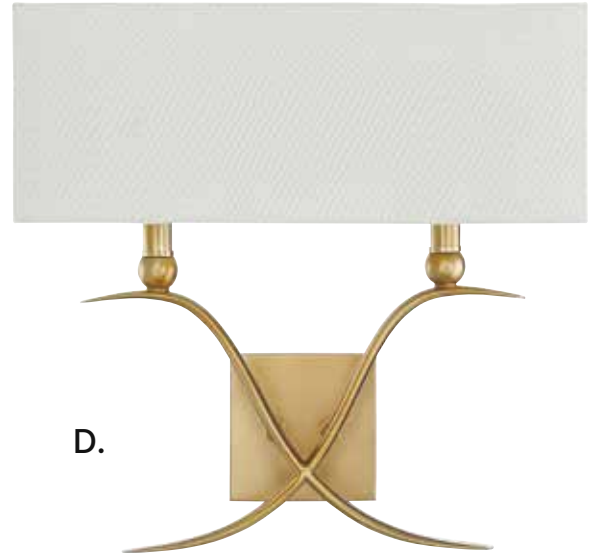

D.

A. 9-800-2-44  
2-Light Sconce  
Classic Bronze Finish  
16"W x 15-1/2"H x 6"E  
2C 60W  
White Linen Shade  
Metal Candle Covers

B. 9-800-2-109  
2-Light Sconce  
Polished Nickel Finish  
16"W x 15-1/2"H x 6"E  
2C 60W  
White Linen Shade  
Metal Candle Covers

C. 9-800-2-SN  
2-Light Sconce  
Satin Nickel Finish  
16"W x 15-1/2"H x 6"E  
2C 60W  
White Linen Shade  
Metal Candle Covers

D. 9-800-2-322  
2-Light Sconce  
Warm Brass Finish  
16"W x 15-1/2"H x 6"E  
2C 60W  
White Linen Shade  
Metal Candle Covers



E.



F.



G.



H.



I.

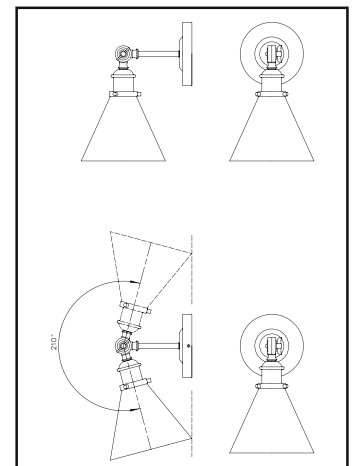

**E. 9-0901-1-SN**  
 1-Light Adjustable Sconce  
 Satin Nickel Finish  
 7"W x 12"H x 9"E  
 1E 60W

**F. 9-0901-1-44**  
 1-Light Adjustable Sconce  
 Classic Bronze Finish  
 7"W x 12"H x 9"E  
 1E 60W

**G. 9-0901-1-109**  
 1-Light Adjustable Sconce  
 Polished Nickel Finish  
 7"W x 12"H x 9"E  
 1E 60W

**H. 9-0901-1-322**  
 1-Light Adjustable Sconce  
 Warm Brass Finish  
 7"W x 12"H x 9"E  
 1E 60W

**I. 9-0901-1-89**  
 1-Light Adjustable Sconce  
 Matte Black Finish  
 7"W x 12"H x 9"E  
 1E 60W

# CAMERON



**A. 9-2542-1-322**  
1-Light Sconce  
Warm Brass Finish  
5"W x 13"H x 8"E  
1C 40W  
White Fabric Shade  
Metal Candle Cover

**B. 9-2542-1-89**  
1-Light Sconce  
Matte Black Finish  
5"W x 13"H x 8"E  
1C 40W  
White Fabric Shade  
Metal Candle Cover

**C. 9-2542-1-109**  
1-Light Sconce  
Polished Nickel Finish  
5"W x 13"H x 8"E  
1C 40W  
White Fabric Shade  
Metal Candle Cover

# WASHBURN



D.



E.



F.



G.

D. 9-0700-1-322  
1-Light Sconce  
Warm Brass Finish  
7"W x 15"H x 9"E  
1C 60W  
White Linen Shade  
Metal Candle Cover

E. 9-0700-1-SN  
1-Light Sconce  
Satin Nickel Finish  
7"W x 15"H x 9"E  
1C 60W  
White Linen Shade  
Metal Candle Cover

F. 9-0700-1-109  
1-Light Sconce  
Polished Nickel Finish  
7"W x 15"H x 9"E  
1C 60W  
White Linen Shade  
Metal Candle Cover

G. 9-0700-1-44  
1-Light Sconce  
Classic Bronze Finish  
7"W x 15"H x 9"E  
1C 60W  
White Linen Shade  
Metal Candle Cover

# PIKE



A.



B.



C.



- A. 9-16000-1-322**  
1-Light Sconce  
Warm Brass Finish  
4-1/2"W x 15-1/4"H x 4-1/2"E  
1E 60W  
Clear Ribbed Glass  
*Bulb Included 300MM T9*
- B. 9-16000-1-109**  
1-Light Sconce  
Polished Nickel Finish  
4-1/2"W x 15-1/4"H x 4-1/2"E  
1E 60W  
Clear Ribbed Glass  
*Bulb Included 300MM T9*
- C. 9-16000-1-44**  
1-Light Sconce  
Classic Bronze Finish  
4-1/2"W x 15-1/4"H x 4-1/2"E  
1E 60W  
Clear Ribbed Glass  
*Bulb Included 300MM T9*

# CLIFTON



E.



D.



F.

D. **9-900-1-322**  
1-Light Sconce  
Warm Brass Finish  
4-1/4"W x 15-1/2"H x 4-1/2"E  
1E 60W  
*Bulb Included 300MM T9*

E. **9-900-1-109**  
1-Light Sconce  
Polished Nickel Finish  
4-1/4"W x 15-1/2"H x 4-1/2"E  
1E 60W  
*Bulb Included 300MM T9*

F. **9-900-1-44**  
1-Light Sconce  
Classic Bronze Finish  
4-1/4"W x 15-1/2"H x 4-1/2"E  
1E 60W  
*Bulb Included 300MM T9*

# MERRILL



- A. 5-801-322**  
1-Light Indoor/Outdoor Sconce  
Warm Brass Finish  
8"W x 21-1/2"H x 8-1/4"E  
1E 60W  
Clear Glass  
*UL Damp Rated*
- B. 5-801-13**  
1-Light Indoor/Outdoor Sconce  
English Bronze Finish  
8"W x 21-1/2"H x 8-1/4"E  
1E 60W  
Clear Glass  
*UL Damp Rated*
- C. 5-801-SN**  
1-Light Indoor/Outdoor Sconce  
Satin Nickel Finish  
8"W x 21-1/2"H x 8-1/4"E  
1E 60W  
Clear Glass  
*UL Damp Rated*
- D. 5-800-322**  
1-Light Indoor/Outdoor Sconce  
Warm Brass Finish  
5-3/4"W x 18"H x 8"E  
1E 60W  
Clear Glass  
*UL Damp Rated*
- E. 5-800-13**  
1-Light Indoor/Outdoor Sconce  
English Bronze Finish  
5-3/4"W x 18"H x 8"E  
1E 60W  
Clear Glass  
*UL Damp Rated*
- F. 5-800-SN**  
1-Light Indoor/Outdoor Sconce  
Satin Nickel Finish  
5-3/4"W x 18"H x 8"E  
1E 60W  
Clear Glass  
*UL Damp Rated*



**DAMP  
Location**



# MERRILL



A.



B.



C.



D.



E.



F.

# MORLAND



A.



B.

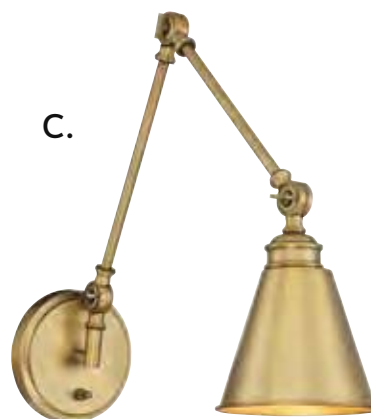

C.

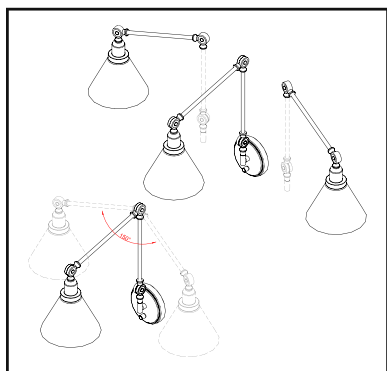

D.



E.

Switch, comes with **Cord & Plug** and **Hardwire**.

**A. 9-961CP-1-89**  
1-Light Adjustable  
Sconce  
Matte Black Finish  
6"W x 16"H x 13"E  
Adj E 13" - 33-3/4"  
1E 60W  
150° Swivel

**B. 9-961CP-1-13**  
1-Light Adjustable  
Sconce  
English Bronze Finish  
6"W x 16"H x 13"E  
Adj E 13" - 33-3/4"  
1E 60W  
150° Swivel

**C. 9-961CP-1-322**  
1-Light Adjustable  
Sconce  
Warm Brass Finish  
6"W x 16"H x 13"E  
Adj E 13" - 33-3/4"  
1E 60W  
150° Swivel

**D. 9-961CP-1-109**  
1-Light Adjustable  
Sconce  
Polished Nickel Finish  
6"W x 16"H x 13"E  
Adj E 13" - 33-3/4"  
1E 60W  
150° Swivel

**E. 9-961CP-1-SN**  
1-Light Adjustable  
Sconce  
Satin Nickel Finish  
6"W x 16"H x 13"E  
Adj E 13" - 33-3/4"  
1E 60W  
150° Swivel



F.



G.



J.



H.



I.

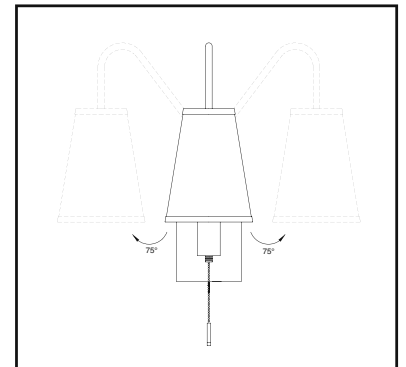

Pull-chain, comes with **Cord & Plug** and **Hardwire**.

**F. 9-0900CP-1-13**  
 1-Light Adjustable Sconce  
 English Bronze Finish  
 6"W x 18"H x 6"E  
 Adj E 6" - 12"  
 1E 60W  
 150° Swivel  
 White Fabric Shade  
 Decorative Pull-Chain ON/OFF

**G. 9-0900CP-1-322**  
 1-Light Adjustable Sconce  
 Warm Brass Finish  
 6"W x 18"H x 6"E  
 Adj E 6" - 12"  
 1E 60W  
 150° Swivel  
 White Fabric Shade  
 Decorative Pull-Chain ON/OFF

**H. 9-0900CP-1-109**  
 1-Light Adjustable Sconce  
 Polished Nickel Finish  
 6"W x 18"H x 6"E  
 Adj E 6" - 12"  
 1E 60W  
 150° Swivel  
 White Fabric Shade  
 Decorative Pull-Chain ON/OFF

**I. 9-0900CP-1-SN**  
 1-Light Adjustable Sconce  
 Satin Nickel Finish  
 6"W x 18"H x 6"E  
 Adj E 6" - 12"  
 1E 60W  
 150° Swivel  
 White Fabric Shade  
 Decorative Pull-Chain ON/OFF

**J. 9-0900CP-1-89**  
 1-Light Adjustable Sconce  
 Matte Black Finish  
 6"W x 18"H x 6"E  
 Adj E 6" - 12"  
 1E 60W  
 150° Swivel  
 White Fabric Shade  
 Decorative Pull-Chain ON/OFF

# DAKOTA

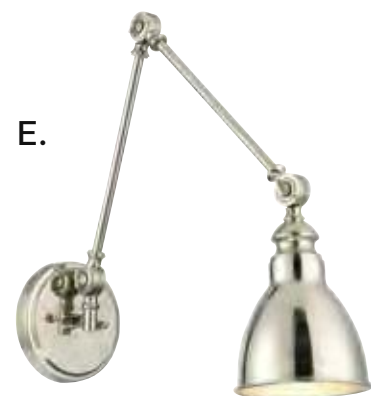
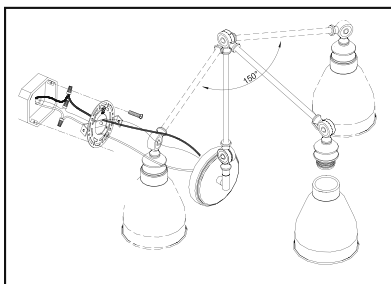
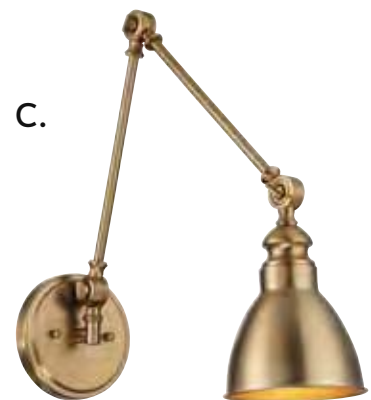

**Hardwire only.**

**A. 9-960-1-89**

1-Light Adjustable  
Sconce  
Matte Black Finish  
5-1/2"W x 17"H x 13"E  
Adj E 13" - 33-3/4"  
1E 60W  
150° Swivel

**B. 9-960-1-13**

1-Light Adjustable  
Sconce  
English Bronze Finish  
5-1/2"W x 17"H x 13"E  
Adj E 13" - 33-3/4"  
1E 60W  
150° Swivel

**C. 9-960-1-322**

1-Light Adjustable  
Sconce  
Warm Brass Finish  
5-1/2"W x 17"H x 13"E  
Adj E 13" - 33-3/4"  
1E 60W  
150° Swivel

**D. 9-960-1-SN**

1-Light Adjustable  
Sconce  
Satin Nickel Finish  
5-1/2"W x 17"H x 13"E  
Adj E 13" - 33-3/4"  
1E 60W  
150° Swivel

**E. 9-960-1-109**

1-Light Adjustable  
Sconce  
Polished Nickel Finish  
5-1/2"W x 17"H x 13"E  
Adj E 13" - 33-3/4"  
1E 60W  
150° Swivel

# DRAKE



F.



G.



H.



I.



J.

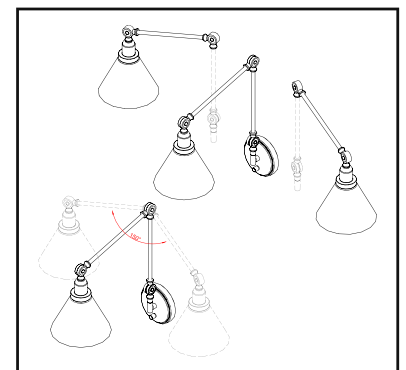

Switch, comes with **Cord & Plug** and **Hardwire**.

**F. 9-9131CP-1-13**  
1-Light Sconce  
English Bronze Finish  
7-1/2"W x 17"H x 14"E  
Adj E 14" - 34-1/2"  
1E 60W  
150° Swivel  
Clear Glass

**G. 9-9131CP-1-322**  
1-Light Sconce  
Warm Brass Finish  
7-1/2"W x 17"H x 14"E  
Adj E 14" - 34-1/2"  
1E 60W  
150° Swivel  
Clear Glass

**H. 9-9131CP-1-109**  
1-Light Sconce  
Polished Nickel Finish  
7-1/2"W x 17"H x 14"E  
Adj E 14" - 34-1/2"  
1E 60W  
150° Swivel  
Clear Glass

**I. 9-9131CP-1-SN**  
1-Light Sconce  
Satin Nickel Finish  
7-1/2"W x 17"H x 14"E  
Adj E 14" - 34-1/2"  
1E 60W  
150° Swivel  
Clear Glass

**J. 9-9131CP-1-89**  
1-Light Sconce  
Matte Black Finish  
7-1/2"W x 17"H x 14"E  
Adj E 14" - 34-1/2"  
1E 60W  
150° Swivel  
Clear Glass

# CARSON

- A. **8-4050-4-SN**  
4-Light Bath Bar  
Satin Nickel Finish  
30"W x 8-1/2"H x 7"E  
4E 60W  
Clear Glass
- B. **8-4050-3-SN**  
3-Light Bath Bar  
Satin Nickel Finish  
22-1/2"W x 8-1/2"H x 7"E  
3E 60W  
Clear Glass
- C. **8-4050-2-SN**  
2-Light Bath Bar  
Satin Nickel Finish  
14"W x 8-1/2"H x 7"E  
2E 60W  
Clear Glass
- D. **9-4050-1-SN**  
1-Light Sconce  
Satin Nickel Finish  
5-1/2"W x 8-1/2"H x 7"E  
1E 60W  
Clear Glass



A.



B.



D.



C.

# CARSON



E.

**E. 8-4050-4-BK**  
4-Light Bath Bar  
Matte Black Finish  
30"W x 8-1/2"H x 7"E  
4E 60W  
Clear Glass



F.

**F. 8-4050-3-BK**  
3-Light Bath Bar  
Matte Black Finish  
22-1/2"W x 8-1/2"H x 7"E  
3E 60W  
Clear Glass



G.

**G. 8-4050-2-BK**  
2-Light Bath Bar  
Matte Black Finish  
14"W x 8-1/2"H x 7"E  
2E 60W  
Clear Glass



H.

**H. 9-4050-1-BK**  
1-Light Sconce  
Matte Black Finish  
5-1/2"W x 8-1/2"H x 7"E  
1E 60W  
Clear Glass



I.

**I. 8-4050-4-322**  
4-Light Bath Bar  
Warm Brass Finish  
30"W x 8-1/2"H x 7"E  
4E 60W  
Clear Glass



J.

**J. 8-4050-3-322**  
3-Light Bath Bar  
Warm Brass Finish  
22-1/2"W x 8-1/2"H x 7"E  
3E 60W  
Clear Glass



K.

**K. 8-4050-2-322**  
2-Light Bath Bar  
Warm Brass Finish  
14"W x 8-1/2"H x 7"E  
2E 60W  
Clear Glass



L.

**L. 9-4050-1-322**  
1-Light Sconce  
Warm Brass Finish  
5-1/2"W x 8-1/2"H x 7"E  
1E 60W  
Clear Glass

Fixtures may be mounted as either **Uplight** or **Downlight**.

# MARSHALL

---





# MARSHALL



A.



B.



C.



D.



E.



F.

- A. 8-8020-4-BK**  
4-Light Bath Bar  
Matte Black Finish  
31"W x 9-1/2"H x 6-1/2"E  
4E 60W  
Clear Seeded Glass
- B. 8-8020-3-BK**  
3-Light Bath Bar  
Matte Black Finish  
22"W x 9-1/2"H x 6-1/2"E  
3E 60W  
Clear Seeded Glass
- C. 8-8020-2-BK**  
2-Light Bath Bar  
Matte Black Finish  
13-1/4"W x 9-1/2"H x 6-1/2"E  
2E 60W  
Clear Seeded Glass
- D. 8-8020-4-11**  
4-Light Bath Bar  
Polished Chrome Finish  
31"W x 9-1/2"H x 6-1/2"E  
4E 60W  
Clear Seeded Glass
- E. 8-8020-3-11**  
3-Light Bath Bar  
Polished Chrome Finish  
22"W x 9-1/2"H x 6-1/2"E  
3E 60W  
Clear Seeded Glass
- F. 8-8020-2-11**  
2-Light Bath Bar  
Polished Chrome Finish  
13-1/4"W x 9-1/2"H x 6-1/2"E  
2E 60W  
Clear Seeded Glass

Fixtures may be mounted as either **Uplight** or **Downlight**.

# OCTAVE

---



# OCTAVE



A.



C.



D.



E.



G.



H.



B.



F.

- A. **8-4030-2-BK**  
2-Light Bath Bar  
Matte Black Finish  
13-3/4"W x 9"H x 5-1/2"E  
2E 60W  
Clear Glass
- B. **9-4030-1-BK**  
1-Light Sconce  
Matte Black Finish  
5"W x 9-1/2"H x 6"E  
1E 60W  
Clear Glass
- C. **8-4030-3-BK**  
3-Light Bath Bar  
Matte Black Finish  
21"W x 9"H x 5-1/2"E  
3E 60W  
Clear Glass
- D. **8-4030-4-BK**  
4-Light Bath Bar  
Matte Black Finish  
28-3/4"W x 9"H x 5-1/2"E  
4E 60W  
Clear Glass
- E. **8-4030-2-11**  
2-Light Bath Bar  
Polished Chrome Finish  
13-3/4"W x 9"H x 5-1/2"E  
2E 60W  
Clear Glass
- F. **9-4030-1-11**  
1-Light Sconce  
Polished Chrome Finish  
5"W x 9-1/2"H x 6"E  
1E 60W  
Clear Glass
- G. **8-4030-3-11**  
3-Light Bath Bar  
Polished Chrome Finish  
21"W x 9"H x 5-1/2"E  
3E 60W  
Clear Glass
- H. **8-4030-4-11**  
4-Light Bath Bar  
Polished Chrome Finish  
28-3/4"W x 9"H x 5-1/2"E  
4E 60W  
Clear Glass

Fixtures may be mounted as either **Uplight** or **Downlight**.

# OCTAVE

**A. 9-4030-1-13**

1-Light Sconce  
English Bronze Finish  
5"W x 9-1/2"H x 6"E  
1E 60W  
Clear Glass



**B. 8-4030-2-13**

2-Light Bath Bar  
English Bronze Finish  
13-3/4"W x 9"H x 5-1/2"E  
2E 60W  
Clear Glass

**B.**



**C. 8-4030-3-13**

3-Light Bath Bar  
English Bronze Finish  
21"W x 9"H x 5-1/2"E  
3E 60W  
Clear Glass

**A.**

**C.**



**D. 8-4030-4-13**

4-Light Bath Bar  
English Bronze Finish  
28-3/4"W x 9"H x 5-1/2"E  
4E 60W  
Clear Glass

**D.**



**E. 9-4030-1-322**

1-Light Sconce  
Warm Brass Finish  
5"W x 9-1/2"H x 6"E  
1E 60W  
Clear Glass



**E.**

**F. 8-4030-2-322**

2-Light Bath Bar  
Warm Brass Finish  
13-3/4"W x 9"H x 5-1/2"E  
2E 60W  
Clear Glass

**F.**



**G. 8-4030-3-322**

3-Light Bath Bar  
Warm Brass Finish  
21"W x 9"H x 5-1/2"E  
3E 60W  
Clear Glass

**G.**



**H. 8-4030-4-322**

4-Light Bath Bar  
Warm Brass Finish  
28-3/4"W x 9"H x 5-1/2"E  
4E 60W  
Clear Glass

**H.**



Fixtures may be mounted as either **Uplight** or **Downlight**.

# OCTAVE



- I. **8-4030-2-SN**  
2-Light Bath Bar  
Satin Nickel Finish  
13-3/4"W x 9"H x 5-1/2"E  
2E 60W  
Clear Glass
- J. **9-4030-1-SN**  
1-Light Sconce  
Satin Nickel Finish  
5"W x 9-1/2"H x 6"E  
1E 60W  
Clear Glass
- K. **8-4030-3-SN**  
3-Light Bath Bar  
Satin Nickel Finish  
21"W x 9"H x 5-1/2"E  
3E 60W  
Clear Glass
- L. **8-4030-4-SN**  
4-Light Bath Bar  
Satin Nickel Finish  
28-3/4"W x 9"H x 5-1/2"E  
4E 60W  
Clear Glass



I.



J.



K.



L.

# DRAKE

---

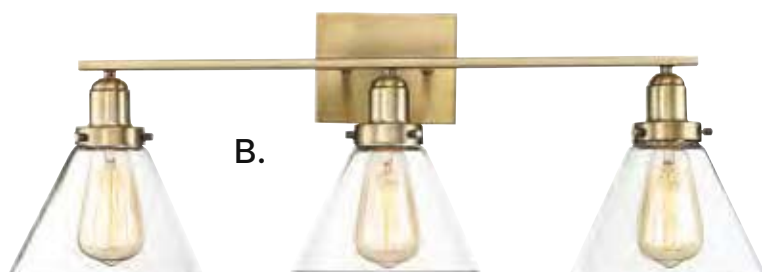

Fixtures may be mounted as either **Uplight** or **Downlight**.

# DRAKE



- A. **8-9130-4-322**  
4-Light Bath Bar  
Warm Brass Finish  
38"W x 10"H x 7-1/2"E  
4E 60W  
Clear Glass
- B. **8-9130-3-322**  
3-Light Bath Bar  
Warm Brass Finish  
28-1/2"W x 10"H x  
7-1/2"E  
3E 60W  
Clear Glass
- C. **8-9130-2-322**  
2-Light Bath Bar  
Warm Brass Finish  
17-3/4"W x 10"H x  
7-1/2"E  
2E 60W  
Clear Glass
- D. **8-9130-2-BK**  
2-Light Bath Bar  
Matte Black Finish  
17-3/4"W x 10"H x  
7-1/2"E  
2E 60W  
Clear Glass
- E. **8-9130-3-BK**  
3-Light Bath Bar  
Matte Black Finish  
28-1/2"W x 10"H x  
7-1/2"E  
3E 60W  
Clear Glass
- F. **8-9130-4-BK**  
4-Light Bath Bar  
Matte Black Finish  
38"W x 10"H x 7-1/2"E  
4E 60W  
Clear Glass

# DRAKE



- |                                                                                                                                    |                                                                                                                                            |                                                                                                                                            |                                                                                                                                          |                                                                                                                                          |                                                                                                                                  |
|------------------------------------------------------------------------------------------------------------------------------------|--------------------------------------------------------------------------------------------------------------------------------------------|--------------------------------------------------------------------------------------------------------------------------------------------|------------------------------------------------------------------------------------------------------------------------------------------|------------------------------------------------------------------------------------------------------------------------------------------|----------------------------------------------------------------------------------------------------------------------------------|
| <p><b>A. 8-9130-4-109</b><br/>4-Light Bath Bar<br/>Polished Nickel Finish<br/>38"W x 10"H x 7-1/2"E<br/>4E 60W<br/>Clear Glass</p> | <p><b>B. 8-9130-3-109</b><br/>3-Light Bath Bar<br/>Polished Nickel Finish<br/>28-1/2"W x 10"H x<br/>7-1/2"E<br/>3E 60W<br/>Clear Glass</p> | <p><b>C. 8-9130-2-109</b><br/>2-Light Bath Bar<br/>Polished Nickel Finish<br/>17-3/4"W x 10"H x<br/>7-1/2"E<br/>2E 60W<br/>Clear Glass</p> | <p><b>D. 8-9130-2-13</b><br/>2-Light Bath Bar<br/>English Bronze Finish<br/>17-3/4"W x 10"H x<br/>7-1/2"E<br/>2E 60W<br/>Clear Glass</p> | <p><b>E. 8-9130-3-13</b><br/>3-Light Bath Bar<br/>English Bronze Finish<br/>28-1/2"W x 10"H x<br/>7-1/2"E<br/>3E 60W<br/>Clear Glass</p> | <p><b>F. 8-9130-4-13</b><br/>4-Light Bath Bar<br/>English Bronze Finish<br/>38"W x 10"H x 7-1/2"E<br/>4E 60W<br/>Clear Glass</p> |
|------------------------------------------------------------------------------------------------------------------------------------|--------------------------------------------------------------------------------------------------------------------------------------------|--------------------------------------------------------------------------------------------------------------------------------------------|------------------------------------------------------------------------------------------------------------------------------------------|------------------------------------------------------------------------------------------------------------------------------------------|----------------------------------------------------------------------------------------------------------------------------------|



# DRAKE



Fixtures may be mounted as either **Uplight** or **Downlight**.

# CALHOUN

---



# CALHOUN



A.

- A. 8-1020-4-SN**  
4-Light Bath Bar  
Satin Nickel Finish  
32"W x 8-3/4"H x 6-3/8"E  
4E 60W  
Clear Glass



B.

- B. 8-1020-3-SN**  
3-Light Bath Bar  
Satin Nickel Finish  
24"W x 8-3/4"H x 6-3/8"E  
3E 60W  
Clear Glass



C.

- C. 8-1020-2-SN**  
2-Light Bath Bar  
Satin Nickel Finish  
14-5/8"W x 8-3/4"H x 6-3/8"E  
2E 60W  
Clear Glass



D.

- D. 8-1020-2-BK**  
2-Light Bath Bar  
Matte Black Finish  
14-5/8"W x 8-3/4"H x 6-3/8"E  
2E 60W  
Clear Glass

- E. 8-1020-3-BK**  
3-Light Bath Bar  
Matte Black Finish  
24"W x 8-3/4"H x 6-3/8"E  
3E 60W  
Clear Glass

- F. 8-1020-4-BK**  
4-Light Bath Bar  
Matte Black Finish  
32"W x 8-3/4"H x 6-3/8"E  
4E 60W  
Clear Glass



E.



F.

Fixtures may be mounted as either **Uplight** or **Downlight**.





A.



B.



C.



D.



E.



F.

- A. **8-7205-4-BK**  
4-Light Bath Bar  
Matte Black Finish  
33"W x 9-3/4"H x 7-1/4"E  
4E 60W  
Clear Glass
- B. **8-7205-3-BK**  
3-Light Bath Bar  
Matte Black Finish  
24"W x 9-3/4"H x 7-1/4"E  
3E 60W  
Clear Glass
- C. **8-7205-2-BK**  
2-Light Bath Bar  
Matte Black Finish  
14-3/4"W x 9-3/4"H x 7-1/4"E  
2E 60W  
Clear Glass
- D. **8-7205-4-SN**  
4-Light Bath Bar  
Satin Nickel Finish  
33"W x 9-3/4"H x 7-1/4"E  
4E 60W  
Clear Glass
- E. **8-7205-3-SN**  
3-Light Bath Bar  
Satin Nickel Finish  
24"W x 9-3/4"H x 7-1/4"E  
3E 60W  
Clear Glass
- F. **8-7205-2-SN**  
2-Light Bath Bar  
Satin Nickel Finish  
14-3/4"W x 9-3/4"H x 7-1/4"E  
2E 60W  
Clear Glass

Fixtures may be mounted as either **Uplight** or **Downlight**.



**A. 8-2542-3-322**  
 3-Light Bath Bar  
 Warm Brass Finish  
 24"W x 12"H x 8"E  
 3C 40W  
 White Fabric Shades  
 Metal Candle Covers

**B. 9-2542-1-322**  
 1-Light Sconce  
 Warm Brass Finish  
 5"W x 13"H x 8"E  
 1C 40W  
 White Fabric Shade  
 Metal Candle Cover

**C. 8-2542-2-322**  
 2-Light Bath Bar  
 Warm Brass Finish  
 15"W x 12"H x 8"E  
 2C 40W  
 White Fabric Shades  
 Metal Candle Covers



# CAMERON



D.

- D. 8-2542-3-89**  
 3-Light Bath Bar  
 Matte Black Finish  
 24"W x 12"H x 8"E  
 3C 40W  
 White Fabric Shades  
 Metal Candle Covers



E.

- E. 8-2542-2-89**  
 2-Light Bath Bar  
 Matte Black Finish  
 15"W x 12"H x 8"E  
 2C 40W  
 White Fabric Shades  
 Metal Candle Covers



F.

- F. 9-2542-1-89**  
 1-Light Sconce  
 Matte Black Finish  
 5"W x 13"H x 8"E  
 1C 40W  
 White Fabric Shade  
 Metal Candle Cover



D.

- G. 8-2542-3-109**  
 3-Light Bath Bar  
 Polished Nickel Finish  
 24"W x 12"H x 8"E  
 3C 40W  
 White Fabric Shades  
 Metal Candle Covers

- H. 8-2542-2-109**  
 2-Light Bath Bar  
 Polished Nickel Finish  
 15"W x 12"H x 8"E  
 2C 40W  
 White Fabric Shades  
 Metal Candle Covers



E.

- I. 9-2542-1-109**  
 1-Light Sconce  
 Polished Nickel Finish  
 5"W x 13"H x 8"E  
 1C 40W  
 White Fabric Shade  
 Metal Candle Cover



F.

# CAPRA

A. **8-4090-4-109**  
4-Light Bath Bar  
Polished Nickel Finish  
31"W x 9"H x 6-1/2"E  
4E 60W  
White Opal Glass



A.

B. **8-4090-3-109**  
3-Light Bath Bar  
Polished Nickel Finish  
22"W x 9"H x 6-1/2"E  
3E 60W  
White Opal Glass



B.

C. **8-4090-2-109**  
2-Light Bath Bar  
Polished Nickel Finish  
15"W x 9"H x 6-1/2"E  
2E 60W  
White Opal Glass



C.

D. **8-4090-4-322**  
4-Light Bath Bar  
Warm Brass Finish  
31"W x 9"H x 6-1/2"E  
4E 60W  
White Opal Glass



D.

E. **8-4090-3-322**  
3-Light Bath Bar  
Warm Brass Finish  
22"W x 9"H x 6-1/2"E  
3E 60W  
White Opal Glass



E.

F. **8-4090-2-322**  
2-Light Bath Bar  
Warm Brass Finish  
15"W x 9"H x 6-1/2"E  
2E 60W  
White Opal Glass



F.





# DARLINGTON



# DARLINGTON



A.



B.



C.



D.



E.



F.

**A. 8-2410-4-322**  
4-Light Bath Bar  
Warm Brass Finish  
33-7/8"W x 8-1/2"H x 7-3/4"E  
4E 60W  
Opalescent Glass

**B. 8-2410-3-322**  
3-Light Bath Bar  
Warm Brass Finish  
25-1/2"W x 8-1/2"H x 7-3/4"E  
3E 60W  
Opalescent Glass

**C. 8-2410-2-322**  
2-Light Bath Bar  
Warm Brass Finish  
18"W x 8-1/2"H x 7-3/4"E  
2E 60W  
Opalescent Glass

**D. 8-2410-4-SN**  
4-Light Bath Bar  
Satin Nickel Finish  
33-7/8"W x 8-1/2"H x 7-3/4"E  
4E 60W  
Opalescent Glass

**E. 8-2410-3-SN**  
3-Light Bath Bar  
Satin Nickel Finish  
25-1/2"W x 8-1/2"H x 7-3/4"E  
3E 60W  
Opalescent Glass

**F. 8-2410-2-SN**  
2-Light Bath Bar  
Satin Nickel Finish  
18"W x 8-1/2"H x 7-3/4"E  
2E 60W  
Opalescent Glass

# MELROSE



**A. 8-6836-2-322**  
2-Light Bath Bar  
Warm Brass Finish  
14-1/2"W x 7-3/4"H x 6-3/4"E  
2E 60W  
White Opal Etched Glass

**B. 8-6836-3-322**  
3-Light Bath Bar  
Warm Brass Finish  
24"W x 7-3/4"H x 6-3/4"E  
3E 60W  
White Opal Etched Glass

**C. 8-6836-4-322**  
4-Light Bath Bar  
Warm Brass Finish  
33-1/2"W x 7-3/4"H x 6-3/4"E  
4E 60W  
White Opal Etched Glass

**D. 9-6836-1-322**  
1-Light Sconce  
Warm Brass Finish  
5"W x 7-3/4"H x 6-3/4"E  
1E 60W  
White Opal Etched Glass

# MELROSE

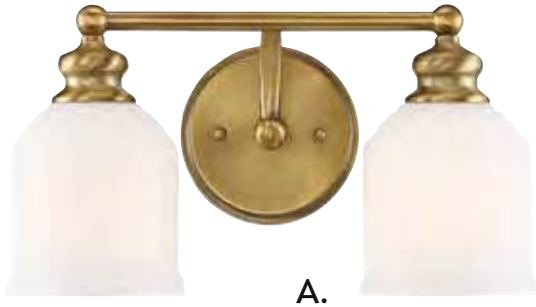

A.



B.



C.



D.

Fixtures may be mounted as either **Uplight** or **Downlight**.



E.



F.



G.



H.

Fixtures may be mounted as either **Uplight** or **Downlight**.

**E. 8-6836-2-SN**  
2-Light Bath Bar  
Satin Nickel Finish  
14-1/2"W x 7-3/4"H x 6-3/4"E  
2E 60W  
White Opal Etched Glass

**F. 8-6836-3-SN**  
3-Light Bath Bar  
Satin Nickel Finish  
24"W x 7-3/4"H x 6-3/4"E  
3E 60W  
White Opal Etched Glass

**G. 8-6836-4-SN**  
4-Light Bath Bar  
Satin Nickel Finish  
33-1/2"W x 7-3/4"H x 6-3/4"E  
4E 60W  
White Opal Etched Glass

**H. 9-6836-1-SN**  
1-Light Sconce  
Satin Nickel Finish  
5"W x 7-3/4"H x 6-3/4"E  
1E 60W  
White Opal Etched Glass

# MELROSE



A.



B.



C.



D.

Fixtures may be mounted as either **Uplight** or **Downlight**.



E.



F.



G.



H.

Fixtures may be mounted as either **Uplight** or **Downlight**.

A. **8-6836-2-13**  
2-Light Bath Bar  
English Bronze Finish  
14-1/2"W x 7-3/4"H x 6-3/4"E  
2E 60W  
White Opal Etched Glass

B. **8-6836-3-13**  
3-Light Bath Bar  
English Bronze Finish  
24"W x 7-3/4"H x 6-3/4"E  
3E 60W  
White Opal Etched Glass

C. **8-6836-4-13**  
4-Light Bath Bar  
English Bronze Finish  
33-1/2"W x 7-3/4"H x 6-3/4"E  
4E 60W  
White Opal Etched Glass

D. **9-6836-1-13**  
1-Light Sconce  
English Bronze Finish  
5"W x 7-3/4"H x 6-3/4"E  
1E 60W  
White Opal Etched Glass

# MELROSE



**E. 8-6836-2-11**  
2-Light Bath Bar  
Polished Chrome Finish  
14-1/2"W x 7-3/4"H x 6-3/4"E  
2E 60W  
White Opal Etched Glass

**F. 8-6836-3-11**  
3-Light Bath Bar  
Polished Chrome Finish  
24"W x 7-3/4"H x 6-3/4"E  
3E 60W  
White Opal Etched Glass

**G. 8-6836-4-11**  
4-Light Bath Bar  
Polished Chrome Finish  
33-1/2"W x 7-3/4"H x 6-3/4"E  
4E 60W  
White Opal Etched Glass

**H. 9-6836-1-11**  
1-Light Sconce  
Polished Chrome Finish  
5"W x 7-3/4"H x 6-3/4"E  
1E 60W  
White Opal Etched Glass

# DELANEY

LED



**A. 8-1960-33-11**

LED Vanity  
Polished Chrome Finish  
24"W x 4-3/4"H x 3-3/4"E  
33W LED Dimmable –  
2400 Lumens, 3000K, 90 CRI  
Clear Faceted Glass



A.

**B. 8-1960-40-11**

LED Vanity  
Polished Chrome Finish  
30"W x 4-3/4"H x 3-3/4"E  
40W LED Dimmable –  
2900 Lumens, 3000K, 90 CRI  
Clear Faceted Glass



B.





C.

- C. 8-1959-53-11**  
LED Vanity  
Polished Chrome Finish  
33-1/4\"/>



D.

- D. 8-1959-35-11**  
LED Vanity  
Polished Chrome Finish  
23-1/4\"/>



E.

- E. 8-1959-25-11**  
LED Vanity  
Polished Chrome Finish  
17-1/4\"/>



F.

- F. 8-1959-25-158**  
LED Vanity  
Classic Brass Finish  
17-1/4\"/>



G.

- G. 8-1959-35-158**  
LED Vanity  
Classic Brass Finish  
23-1/4\"/>



H.

- H. 8-1959-53-158**  
LED Vanity  
Classic Brass Finish  
33-1/4\"/>

Fixtures may be mounted as either **Horizontal** or **Vertical**.

# INDEX

1-0602-6-322.....26	3-3056-4-109.....111	6-3352-2-13.....147	7-204-6-109.....88	8-1020-4-SN.....185	9-0700-1-44.....163
1-0602-6-SN.....26	3-3056-4-13.....110	6-3352-2-322.....147	7-204-6-322.....88	8-1959-25-11.....199	9-0700-1-SN.....163
1-1840-6-322.....6	3-3104-4-109.....93	6-3352-2-SN.....147	7-204-6-44.....88	8-1959-25-158.....199	9-0900CP-1-109.....169
1-1840-6-SN.....6	3-3104-4-322.....93	6-3750-1-109.....122	7-2137-3-11.....102	8-1959-35-11.....199	9-0900CP-1-13.....169
1-1841-8-322.....5	3-3104-4-44.....93	6-3750-1-13.....123	7-2137-3-127.....102	8-1959-35-158.....199	9-0900CP-1-322.....169
1-1841-8-SN.....5	3-320-3-109.....50	6-3750-1-322.....123	7-2137-3-89.....102	8-1959-53-11.....199	9-0900CP-1-89.....169
1-2070-1-109.....127	3-320-3-322.....50	6-3750-1-89.....122	7-2138-4-11.....102	8-1959-53-158.....199	9-0900CP-1-SN.....169
1-2070-1-13.....127	3-320-3-44.....50	6-3750-1-SN.....123	7-2138-4-127.....102	8-1960-33-11.....198	9-0901-1-109.....161
1-2070-1-322.....127	3-320-3-89.....50	6-4035-3-11.....139	7-2138-4-89.....102	8-1960-40-11.....198	9-0901-1-322.....161
1-2070-1-SN.....127	3-320-3-SN.....50	6-4035-3-13.....139	7-2180-3-13.....107	8-2410-2-322.....193	9-0901-1-44.....161
1-2540-5-109.....73	3-321-4-109.....53	6-4035-3-322.....139	7-2180-3-322.....107	8-2410-2-SN.....193	9-0901-1-89.....161
1-2540-5-322.....73	3-321-4-322.....53	6-4035-3-BK.....139	7-2180-3-SN.....107	8-2410-3-322.....193	9-0901-1-SN.....161
1-2540-5-89.....73	3-321-4-44.....53	6-4035-3-SN.....139	7-2201-4-13.....119	8-2410-3-SN.....193	9-0902-1-109.....158
1-2541-9-109.....70	3-321-4-89.....53	6-4037-1-11.....138	7-2201-4-322.....119	8-2410-4-322.....193	9-0902-1-322.....158
1-2541-9-322.....70	3-321-4-SN.....53	6-4037-1-13.....138	7-2201-4-SN.....119	8-2410-4-SN.....193	9-0902-1-44.....158
1-2541-9-89.....70	3-322-6-109.....54	6-4037-1-322.....138	7-2851-4-154.....19	8-2542-2-109.....189	9-0902-1-89.....158
1-305-6-109.....66	3-322-6-322.....54	6-4037-1-BK.....138	7-2851-4-322.....19	8-2542-2-322.....188	9-1000-1-109.....159
1-305-6-322.....66	3-322-6-44.....54	6-4037-1-SN.....138	7-2852-6-154.....16	8-2542-2-89.....189	9-1000-1-13.....159
1-305-6-44.....66	3-322-6-89.....54	6-4900-4-322.....108	7-2852-6-322.....16	8-2542-3-109.....189	9-1000-1-322.....159
1-305-6-89.....66	3-322-6-SN.....54	6-4900-4-89.....108	7-3100-1-322.....98	8-2542-3-322.....188	9-1000-1-SN.....159
1-305-6-SN.....66	3-325-6-109.....49	6-4900-4-SN.....108	7-3100-1-SN.....98	8-2542-3-89.....189	9-1200-1-109.....152
1-306-8-109.....69	3-325-6-322.....49	6-7110-4-322.....30	7-3102-1-322.....99	8-4030-2-11.....177	9-1200-1-13.....152
1-306-8-322.....69	3-325-6-44.....49	6-7110-4-89.....30	7-3102-1-SN.....99	8-4030-2-13.....178	9-1200-1-322.....152
1-306-8-44.....69	3-325-6-89.....49	6-7110-4-SN.....30	7-3103-4-109.....90	8-4030-2-322.....178	9-1200-1-89.....152
1-306-8-89.....69	3-325-6-SN.....49	6-7200-1-11.....124	7-3103-4-322.....90	8-4030-2-BK.....177	9-1200-1-SN.....152
1-306-8-SN.....69	3-4901-4-322.....108	6-7200-1-322.....125	7-3103-4-44.....90	8-4030-2-SN.....179	9-1201-1-109.....151
1-307-6-109.....38	3-4901-4-89.....108	6-7200-1-89.....124	7-3751-1-109.....122	8-4030-3-11.....177	9-1201-1-322.....151
1-307-6-322.....38	3-4901-4-SN.....108	6-7200-1-SN.....125	7-3751-1-13.....123	8-4030-3-13.....178	9-1201-1-44.....151
1-307-6-44.....38	3-7112-3-322.....33	6-7790-3-109.....135	7-3751-1-322.....123	8-4030-3-322.....178	9-1201-1-89.....151
1-307-6-89.....38	3-7112-3-89.....33	6-7790-3-13.....135	7-3751-1-89.....122	8-4030-3-BK.....177	9-1201-1-SN.....151
1-307-6-SN.....38	3-7112-3-SN.....33	6-7790-3-322.....135	7-3751-1-SN.....123	8-4030-3-SN.....179	9-16000-1-109.....164
1-308-8-109.....41	3-9074-4-67.....82	6-7790-3-89.....135	7-4034-3-11.....78	8-4030-4-11.....177	9-16000-1-322.....164
1-308-8-322.....41	3-9074-4-79.....82	6-7790-3-SN.....135	7-4034-3-13.....76	8-4030-4-13.....178	9-16000-1-44.....164
1-308-8-44.....41	3-9074-8-67.....82	6-780-11-109.....149	7-4034-3-322.....77	8-4030-4-322.....178	9-2542-1-109.....162, 189
1-308-8-89.....41	3-9074-8-79.....82	6-780-11-13.....149	7-4034-3-BK.....79	8-4030-4-BK.....177	9-2542-1-322.....162, 188
1-308-8-SN.....41	3-9099-4-109.....95	6-780-11-322.....149	7-4034-3-SN.....74	8-4030-4-SN.....179	9-2542-1-89.....73, 162,
1-310-10-109.....43	3-9099-4-322.....95	6-780-11-BK.....148	7-4036-1-11.....131	8-4050-2-322.....173	189
1-310-10-322.....43	3-9099-4-44.....95	6-780-11-SN.....149	7-4036-1-13.....131	8-4050-2-BK.....173	9-302-1-109.....157
1-310-10-44.....43	5-800-13.....166	6-780-13-109.....149	7-4036-1-322.....131	8-4050-2-SN.....172	9-302-1-322.....156
1-310-10-89.....43	5-800-322.....166	6-780-13-13.....149	7-4036-1-BK.....131	8-4050-3-322.....173	9-302-1-44.....156
1-310-10-SN.....43	5-800-SN.....166	6-780-13-322.....149	7-4036-1-SN.....131	8-4050-3-BK.....173	9-302-1-89.....155
1-312-15-109.....46	5-801-13.....166	6-780-13-BK.....148	7-5012-1-109.....128	8-4050-3-SN.....172	9-302-1-SN.....155
1-312-15-322.....46	5-801-322.....166	6-780-13-SN.....149	7-5012-1-13.....128	8-4050-4-322.....173	9-303-1-109.....157
1-312-15-44.....46	5-801-SN.....166	6-8502-3-322.....9	7-5012-1-322.....128	8-4050-4-BK.....173	9-303-1-322.....156
1-312-15-89.....45	6-1043-3-109.....112	6-8502-3-89.....10	7-6098-12-109.....87	8-4050-4-SN.....172	9-303-1-44.....156
1-312-15-SN.....46	6-1043-3-13.....112	6-9069-13-109.....145	7-6098-12-322.....87	8-4090-2-109.....190	9-303-1-89.....155
1-323-3-109.....58	6-1043-3-BK.....112	6-9069-13-13.....145	7-6098-12-44.....87	8-4090-2-322.....190	9-303-1-SN.....155
1-323-3-322.....58	6-1043-3-SN.....113	6-9069-13-322.....145	7-6099-24-109.....84	8-4090-3-109.....190	9-4030-1-11.....177
1-323-3-44.....58	6-133-16-109.....142	6-9069-13-SN.....145	7-6099-24-322.....84	8-4090-3-322.....190	9-4030-1-13.....178
1-323-3-89.....58	6-133-16-322.....142	6-9137-1-109.....137	7-6099-24-44.....84	8-4090-4-109.....190	9-4030-1-322.....178
1-323-3-SN.....58	6-133-16-44.....142	6-9137-1-13.....137	7-700-1-109.....133	8-4090-4-322.....190	9-4030-1-BK.....177
1-324-5-109.....61	6-134-3-109.....142	6-9137-1-322.....137	7-700-1-13.....133	8-6836-2-11.....197	9-4030-1-SN.....179
1-324-5-322.....61	6-134-3-322.....142	6-9137-1-89.....137	7-701-1-SN.....133	8-6836-2-13.....196	9-4050-1-322.....173
1-324-5-44.....61	6-134-3-44.....142	6-9137-1-SN.....137	7-702-1-109.....132	8-6836-2-322.....194	9-4050-1-BK.....173
1-324-5-89.....61	6-150-14-109.....144	7-0600-6-322.....26	7-702-1-13.....132	8-6836-2-SN.....195	9-4050-1-SN.....172
1-324-5-SN.....61	6-150-14-44.....144	7-0600-6-SN.....26	7-703-1-SN.....132	8-6836-3-11.....197	9-6836-1-11.....197
1-326-3-109.....63	6-150-14-SN.....144	7-1040-3-109.....112	7-7111-4-322.....31	8-6836-3-13.....196	9-6836-1-13.....196
1-326-3-322.....63	6-1662-4-109.....34	7-1040-3-13.....112	7-7111-4-89.....31	8-6836-3-322.....194	9-6836-1-322.....194
1-326-3-44.....63	6-1662-4-322.....34	7-1040-3-BK.....112	7-7111-4-SN.....31	8-6836-3-SN.....195	9-6836-1-SN.....195
1-327-5-109.....64	6-1662-4-89.....37	7-1040-3-SN.....113	7-7201-1-11.....124	8-6836-4-11.....197	9-7144-1-109.....157
1-327-5-322.....64	6-2182-16-13.....106	7-1041-6-109.....114	7-7201-1-322.....125	8-6836-4-13.....196	9-7144-1-322.....156
1-327-5-44.....64	6-2182-16-322.....106	7-1041-6-13.....115	7-7201-1-89.....124	8-6836-4-322.....194	9-7144-1-44.....156
1-4031-3-11.....78	6-2182-16-SN.....106	7-1041-6-BK.....115	7-7201-1-SN.....125	8-6836-4-SN.....195	9-7144-1-89.....155
1-4031-3-13.....76	6-2183-3-13.....107	7-1041-6-SN.....115	7-8401-4-89.....12	8-7205-2-BK.....187	9-7144-1-SN.....155
1-4031-3-322.....77	6-2183-3-322.....107	7-130-1-109.....121	7-8401-4-SN.....15	8-7205-2-SN.....187	9-800-2-109.....160
1-4031-3-BK.....79	6-2183-3-SN.....107	7-130-1-44.....121	7-8501-5-322.....9	8-7205-3-BK.....187	9-800-2-322.....160
1-4031-3-SN.....74	6-2390-14-109.....140	7-130-1-63.....121	7-8501-5-89.....10	8-7205-3-SN.....187	9-800-2-44.....160
1-4032-5-11.....78	6-2390-14-322.....140	7-130-1-SN.....121	7-8700-4-109.....20	8-7205-4-BK.....187	9-800-2-SN.....160
1-4032-5-13.....76	6-2390-14-89.....140	7-131-1-109.....116	7-8700-4-13.....25	8-7205-4-SN.....187	9-900-1-109.....165
1-4032-5-322.....77	6-2390-14-SN.....140	7-131-1-322.....116	7-8700-4-322.....22	8-8020-2-11.....175	9-900-1-322.....165
1-4032-5-BK.....79	6-2706-3-109.....141	7-131-1-323.....116	7-8701-6-109.....20	8-8020-2-BK.....175	9-900-1-44.....165
1-4032-5-SN.....74	6-2706-3-322.....141	7-131-1-89.....116	7-8701-6-13.....25	8-8020-3-11.....175	9-9131CP-1-109.....171
1-4033-9-11.....78	6-2706-3-44.....141	7-132-1-109.....116	7-8701-6-322.....22	8-8020-3-BK.....175	9-9131CP-1-13.....171
1-4033-9-13.....76	6-3058-4-109.....111	7-132-1-322.....116	7-9006-3-109.....105	8-8020-4-11.....175	9-9131CP-1-322.....171
1-4033-9-322.....77	6-3058-4-13.....110	7-132-1-323.....116	7-9006-3-13.....105	8-8020-4-BK.....175	9-9131CP-1-89.....171
1-4033-9-BK.....79	6-328-4-109.....57	7-132-1-89.....116	7-9006-3-322.....105	8-9130-2-109.....182	9-9131CP-1-SN.....171
1-4033-9-SN.....74	6-328-4-322.....57	7-1660-6-109.....34	7-9006-3-89.....105	8-9130-2-13.....182	9-960-1-109.....170
1-7113-8-322.....29	6-328-4-44.....57	7-1660-6-322.....34	7-9006-3-SN.....105	8-9130-2-322.....181	9-960-1-13.....170
1-7113-8-89.....29	6-328-4-89.....57	7-1660-6-89.....37	7-9132-1-109.....130	8-9130-2-BK.....181	9-960-1-322.....170
1-7113-8-SN.....29	6-328-4-SN.....57	7-17000-1-109.....129	7-9132-1-13.....130	8-9130-3-109.....182	9-960-1-89.....170
1-8400-8-89.....12	6-3350-14-109.....146	7-17000-1-13.....129	7-9132-1-322.....130	8-9130-3-13.....182	9-960-1-SN.....170
1-8400-8-SN.....15	6-3350-14-13.....146	7-17000-1-322.....129	7-9132-1-SN.....130	8-9130-3-322.....181	9-961CP-1-109.....168
1-8500-5-322.....9	6-3350-14-322.....146	7-200-3-322.....101	7-9160-1-109.....100	8-9130-3-BK.....181	9-961CP-1-13.....168
1-8500-5-89.....10	6-3350-14-SN.....146	7-200-3-57.....101	7-9160-1-322.....100	8-9130-4-109.....182	9-961CP-1-322.....168
1-8702-8-109.....20	6-3350-16-109.....146	7-201-4-322.....101	7-9161-4-109.....100	8-9130-4-13.....182	9-961CP-1-89.....168
1-8702-8-13.....25	6-3350-16-13.....146	7-201-4-57.....101	7-9161-4-322.....100	8-9130-4-322.....181	9-961CP-1-SN.....168
1-8702-8-322.....22	6-3350-16-322.....146	7-203-2-109.....96	8-1020-2-BK.....185	8-9130-4-BK.....181	
1-9075-6-67.....81	6-3350-16-SN.....146	7-203-2-322.....96	8-1020-2-SN.....185	9-0601-1-322.....26	
1-9075-6-79.....81	6-3351-3-13.....147	7-203-2-44.....96	8-1020-3-BK.....185	9-0601-1-SN.....26	
3-3055-4-109.....111	6-3351-3-322.....147	7-203-2-89.....96	8-1020-3-SN.....185	9-0700-1-109.....163	
3-3055-4-13.....110	6-3351-3-SN.....147	7-203-2-SN.....96	8-1020-4-BK.....185	9-0700-1-322.....163	

# FINISH GUIDE

02	.....	OILED BRONZE	111	.....	SATIN NICKEL W/ POLISHED NICKEL ACCENTS
05	.....	OILED COPPER	112	.....	WEATHERED BIRCH
8	.....	NEW TORTOISE SHELL W/ SILVER	115	.....	RUSTIC BLACK W/ ROPE
11	.....	POLISHED CHROME	116	.....	FARMHOUSE TIN
12	.....	CHATEAU LINEN	118	.....	CHARISMA
13	.....	ENGLISH BRONZE	119	.....	SMOKE
21	.....	BURNISHED RUSSET	120	.....	PROVINCIAL WOOD W/ EBONY
23	.....	WHITE WASHED DRIFTWOOD	121	.....	MOHICAN BRONZE
25	.....	SLATE	122	.....	GOLD DUST
27	.....	INDUSTRIAL STEEL	123	.....	WHITE W/ SILVER LEAF
28	.....	OILED BURNISHED BRONZE	124	.....	FIESTA BRONZE
32	.....	ARTISAN RUST	126	.....	BLACK W/ GOLD LEAF
33	.....	GOLD BULLION	127	.....	NOBLE BRASS
39	.....	FOSSIL STONE	128	.....	OXIDIZED SILVER
40	.....	WALNUT PATINA	129	.....	ESPRESSO
41	.....	DURANGO	132	.....	MOONLIT BARK
42	.....	GALAXY BRONZE	135	.....	TEXTURED WHITE W/ SILVER LEAF
44	.....	CLASSIC BRONZE	136	.....	TEXTURED BLACK W/ GOLD LEAF
45	.....	AGED WOOD	139	.....	PEWTER AND GREYWOOD
49	.....	WINTERWOOD	141	.....	TEXTURED BRONZE W/ GOLD HIGHLIGHTS
50	.....	HARNESS LEATHER W/ RUBBED BRASS	143	.....	BLACK W/ WARM BRASS ACCENTS
51	.....	VINTAGE BLACK W/ WARM BRASS FINISH	144	.....	SATIN NICKEL W/ CHROME ACCENTS
53	.....	SILVER PATINA	145	.....	MATTE BLACK W/ SATIN NICKEL ACCENTS
54	.....	GOLD PATINA	147	.....	CASTILLO
56	.....	NEW TORTOISE SHELL	148	.....	ESTATE BRASS
57	.....	POLISHED PEWTER	149	.....	WEATHERED ASH
60	.....	AVALITE	150	.....	BLACK STEEL
61	.....	BRONZE ORE	152	.....	MONACO
62	.....	COMO BLACK W/ GOLD	153	.....	BLACK W/ GOLD HIGHLIGHTS
63	.....	WARM BRASS LUSTRE	154	.....	ANTIQUÉ NICKEL
64	.....	FIELDSTONE	155	.....	PROVENCE W/ GOLD ACCENTS
67	.....	MATTE BLACK W/ POLISHED CHROME ACCENTS	158	.....	CLASSIC BRASS
68	.....	WHISKEY WOOD	160	.....	WHITE W/ BRASS ACCENTS
69	.....	PEWTER	161	.....	NAVY BLUE W/ BRASS ACCENTS
70	.....	WEATHERVANE	162	.....	AGED DRIFTWOOD
72	.....	RUSTIC BRONZE	163	.....	OLDE GRAY
76	.....	FLORENCIAN BRONZE	164	.....	NANTUCKET
77	.....	BRONZE W/ BRASS ACCENTS	176	.....	SILVER LACE
79	.....	ENGLISH BRONZE AND WARM BRASS	187	.....	BRUSHED PEWTER
80	.....	MATTE WHITE	196	.....	RECLAIMED WOOD
82	.....	PORCELLANA	211	.....	ARGENTUM
84	.....	RUBBED BRONZE W/ GOLD LEAF	212	.....	ARGENTUM & GOLD
85	.....	RUBBED ZINC W/ SILVER LEAF	213	.....	ENGLISH BRONZE W/ GOLD
87	.....	WOODLAND BRONZE	242	.....	AGED STEEL
88	.....	OXIDIZED BLACK	272	.....	SILVER DUST
89	.....	MATTE BLACK	307	.....	SILVER SPARKLE
90	.....	GALVANIZED METAL	322	.....	WARM BRASS
94	.....	AVIGNON	323	.....	OLD BRONZE
95	.....	WARM BRASS W/ BRONZE ACCENTS	330	.....	TEXTURED BRONZE
96	.....	BARRELWOOD W/ BRASS ACCENTS	BK/BLK	.....	MATTE BLACK
98	.....	PYRITE	BN	.....	BROWNSTONE
99	.....	PROVENCE	CH	.....	CHROME
100	.....	AURORA	FB	.....	FLAT BLACK
101	.....	NOBLEWOOD W/ IRON	SN	.....	SATIN NICKEL
103	.....	VINTAGE BRASS	WH/WHT	.....	WHITE
106	.....	CHROME AND METALLIC BRONZE			
109	.....	POLISHED NICKEL			

S  
A  
V  
O  
Y  
  
H  
O  
U  
S  
E



3130 North Berkeley Lake Road NW ♦ Duluth, GA 30096  
800 801 1621 TEL 404 890 7540 ♦ FAX 877 547 2869  
SavoyHouse.com