

**Pataviumart®**

*Luxury Lighting - Unique Objects - Brilliant Ideas*

# INDICE

<b>Introduzione</b>	4
<b>Collezioni</b>	
Appliques	16
Lampadari	34
Plafoniere	86
Piantane	94
Lampade da Tavolo	106
<b>Accessori</b>	288
<b>Personalizzazioni</b>	292
<b>Indice alfabetico dei prodotti</b>	294
<b>Un Catalogo facile</b>	
Come usare questo Catalogo	298
La Codifica degli Articoli	299
<b>Legende</b>	300
Legenda dei Colori delle Rifiniture	
Legenda dei Colori dei Cristalli e Vetri di Murano	
Legenda dei Colori dei Fiori di Vetro e di Conterria	
<b>Condizioni di Vendita</b>	302
<b>Ringraziamenti</b>	308
<b>Redazionale &amp; Contatti</b>	308

# INDEX

<b>Introduction</b>	4
<b>Collections</b>	
Appliques	16
Chandeliers	34
Ceiling Lamps	86
Floor Lamps	94
Table Lamps	106
<b>Accessories</b>	288
<b>Tailor-Made Services</b>	292
<b>Alphabetical Index</b>	294
<b>A Catalogue simple to use</b>	
How to use this Catalogue	298
Using the Article Code	299
<b>Appendix &amp; Tables</b>	300
Frame Finishes & Codes	
Crystal & Murano Glass Colours	
Glass & Bead Flower Colours & Codes	
<b>Terms &amp; Conditions of Sales &amp; Trading</b>	302
<b>Acknowledgments &amp; Credits</b>	308
<b>Editorial &amp; Contacts</b>	308



## Ecco i miei Gioielli

Quando cominciarono a prendere forma i primi vaghi pensieri relativi alla creazione e realizzazione delle più recenti Collezioni, innumerevoli furono le idee su futuri designs, possibili colori, abbinamenti di forme e materiali che ci catturarono. Temperamenti, gusti, stili di vita diversi e variegati ma uniti da un unico motivo dominante, quello della ricerca del veramente bello, unico, affascinante. Tutto ciò doveva fondersi con le antiche tradizioni veneziane, italiane, mediterranee. Già lunga era la storia della nostra azienda, legata a valori immutabili, a prodotti di inimitabile bellezza, storici eppur attuali, con un'anima senza tempo. Era questa l'essenza di qualsiasi oggetto nuovo, conquistare l'osservatore.

Vigore dovevano dare queste creazioni alla nostra società, portare l'Artigianato intrinseco nelle nostre vene ad amalgamarsi con il design più maestoso, più raffinato, più vibrante, nei cinque continenti. Testimonianza dovevano dare della nostra immaginazione, della nostra creatività, della nostra dedizione. Certo, di lusso parliamo, quanto è lusso sapersi e potersi godere il bello, apprezzare la sua purezza, il suo valore e ritrovarlo racchiuso in una limpida e prestigiosa funzionalità...

Ogni singolo nuovo articolo doveva essere collocabile in ambienti esclusivi come oggetto centrale, catturare l'attenzione, generare emozioni forti, personali ed intensificare l'atmosfera di ogni sala, ogni foyer, ogni palazzo o albergo. Impossibile, verrebbe da dire, ma tanta strada è stata fatta da allora, ed impossibile sarebbe stato prevedere l'impatto profondo che le nostre collezioni avrebbero avuto su tante, tante persone in varie parti del mondo. Oggi, questo libro, meravigliosamente illustrato e sapientemente strutturato, esiste per renderVi testimonianza ed è con grande orgoglio e piacere che Vi accompagneremo attraverso le sue pagine, le sue immagini così vive, i suoi grafici così chiari e le sue legende informative e facili da usare.

Copriamo con questa edizione una selezione di oggetti delle varie Collezioni, oggetti con caratteristiche uniche, tanti, quasi tutti, con una moltitudine di varianti e misure disponibili, resi accessibili tramite una decodifica illustrata e spiegata in maniera logica. Abbiamo dedicato anche a questo molta attenzione e siamo certi che il suo uso Vi sarà facile e molto intuitivo. Tanto è stato fatto, tanto è stato ideato e creato per Voi, con grande dedizione e soddisfazione, e con il desiderio e l'augurio, che i nostri oggetti Vi possano regalare e le stesse emozioni ed esercitare su Voi lo stesso fascino che hanno suscitato in noi durante la loro realizzazione.

Ma sappiamo bene che niente è adatto ad ogni persona, ogni ambiente, ogni occasione; niente è immutabile, non tutto è prevedibile ed infinite sono le variabili e le combinazioni di fattori che rendono unico un oggetto. Per questo abbiamo ritenuto importante includere in questo libro alcune indicazioni per eventuali possibili modifiche degli articoli; sfogliate le pagine dedicate alla personalizzazione dei prodotti e scoprirete, che tanto, ma tanto è possibile... Sappiamo bene che una variazione di misura, di un colore o di una forma, una modifica di un piccolo dettaglio a volte possa regalare un'emozione immensa in più...!

Troverete quindi in fondo al libro le legende sistematiche e complete che illustrano le rifiniture delle strutture e dei colori dei cristalli e dei vetri di Murano. Apritele accanto alla pagina dell'articolo che ha catturato il Vostro interesse; scoprirete così le varianti, le misure, le rifiniture e le sfumature dei colori disponibili per ogni oggetto. Il tutto risulterà semplice, chiaro ed intuitivo e niente Vi distrarrà dall'oggetto che Vi ha affascinato! È con questo augurio che Vi presentiamo questo volume, anch'esso una piccola opera d'arte. Vi invitiamo a concederVi il tempo per poter apprezzare e scegliere con calma e sapienza una o più di una fra le nostre creazioni, affinché esse siano anche per Voi, come lo sono state per noi, una espressione della Vostra immaginazione...

Simonetta Gomiero

## Here are my Jewels

When the first vague thoughts of creating and realizing the last Collections started to come into focus, many were the ideas on future designs, possible colours, particular shapes and new materials which captured us. Various and different personalities, characters, tastes, life styles, united by a common passion - the desire to find real beauty, something unique and fascinating. All this had to merge with antique Venetian, Italian, and Mediterranean traditions. Long had been the history of our company already at that time, bound to immutable values, to products of unequalled beauty, historical but yet so contemporary, with a timeless soul. This was and should be the essence of any new object, noticeable at first sight, attracting and conquering any observer.

They had to give vigour to our company, make the craftsmanship, so intrinsic in our veins, meet the majestic, delicate and vibrating design on the five continents. Testimony they had to give of our imagination, our creativity, our devotion to our work. Without doubt, it is luxury that we are talking about, as it is luxury to be able to appreciate mere beauty, its purity and value and, then, find everything embraced by a crystal and prestigious functionality.

Suitable had to be each single article, suitable to exclusive environments and ambiances as their central object, eye-catching, generate strong emotions in every spectator and intensify the atmosphere of every hall, every foyer, every palace, villa or hotel. Impossible you would be tempted to say, but much has been done since those days and really impossible it was for us to predict the enormous impact which our Collections were going to have on so many persons in as many parts of the whole world.

Today this volume exists, lavishly illustrated and structured, with a great sense of functionality and beauty to give witness. It is with enormous pleasure that we would like to lead you through its pages, its brisk and plastic images, its sober graphics and its clear appendix and tables so simple to use. With this edition we cover a selection of items chosen from the various Collections, items with unique characteristics, many, most of them available in a multitude of versions and sizes. All are made accessible with the help of logically illustrated decoding tables. We have dedicated much attention to this in order to facilitate the use of this catalogue which, as we do hope, should be easy and intuitive.

Much has been made, much has been designed and subsequently created for you, honestly speaking, with a lot of satisfaction and with the wish that our Collection might stir your imagination and evoke the same emotion and fascination which we felt during its creations and realization. Nevertheless, we know that nothing is suitable for everybody, every ambience, every occasion; nothing is immutable, much cannot be predicted and many are the factors and combinations which influence the beauty of an object. It is for this reason that we have included in this book some indications on possible modifications of our articles leaf through the pages dedicated to the tailormade services for our products and you will discover that much is possible. We know well that sometimes a variation of a size, of a colour, of a shape or of just a small detail may provoke fascination and strong emotions!

At the end of the volume you will find the methodical and complete tables which illustrate the frame finishes and the colours of the crystals and Murano glasses. Open them carefully opposite the page of the articles of your interest; you will discover many varieties, different sizes and dimensions, a considerable choice of finishes and colours which are available for each item. Simple, clear and intuitive. And nothing will be able to distract from the object of your desire! And it is with this wish that we present you this volume, a small piece of art, too.

We invite you to take your time when you leaf through it, with care and attention. Enjoy the numberless unique creations which you will find, choose what you really like and let it become for you what it has been and is for us - an expression of your imagination!

Simonetta Gomiero

Simonetta Gomiero

Ines Piccolo  
e Adriano Gomiero



## UN'AVVENTURA COMINCIATA NEL 1959

Nessuno, nel lontano 1959, nemmeno Adriano Gomiero e sua moglie Ines Piccolo, avrebbero potuto immaginarsi a che cosa stavano per dare inizio.

Lontano sembra l'anno, lontana e tanto diversa era la vita in quel periodo con i suoi modi, costumi, gusti; eppure, simili se non uguali a quelli della vita di oggi apparivano i sogni e le speranze, l'ottimismo, la creatività e l'intraprendenza così tipica per le persone giovani come lo erano loro. Certo è che nasce qui, in quei caratteri decisi, fiduciosi nelle proprie capacità, nella propria determinazione, nella forte volontà e nel loro ottimismo l'idea della nostra Pataviumart, una delle più belle realtà nel mondo della illuminazione di design di oggi.

Erano innamorati, pieni di voglia di vivere, di creare, di dare spazio ed espressione alle loro idee, al loro ideale di bellezza e al loro sogno insistente di realizzare oggetti che trasmettessero tutto ciò ad altre persone.

Lui, Adriano, con innata genialità artistica ed il candido ottimismo dei sognatori rari, sensibile e così emozionabile di fronte alla perfezione dei grandi maestri classici italiani ed europei; lei, Ines, con un carattere forte e deciso, organizzatrice con uno spiccato ed acuto senso pratico accompagnato dalla impareggiabile dolcezza della donna innamorata. Insieme sentivano la vocazione di fondare la Pataviumart per realizzare il loro sogno.

Nasce così, da un loro sogno di ieri, la realtà ed il nostro sogno di oggi... Adriano, artigiano di nascita, studioso prima e esperto Maestro d'Arte in seguito, comincia a sviluppare insieme alla moglie la prima collezione di oggetti di illuminazione di Pataviumart nella vecchia sede di Padova (lat. "Patavium"), città con una storica e ben nota tradizione nell'arte e come tale prima ispiratrice per il nome della società.

Basandosi su opere antiche e storiche, le lampade ed i chandeliers di Pataviumart vengono da loro sapientemente ridisegnati, ricreati e riprodotti per essere successivamente perfezionati con un'abilità artistica senza paragoni.

Seguendo antichi metodi viene usata la fusione dell'ottone a terra per riprodurre le strutture di ogni singolo oggetto, completandolo con paralumi unici ed accessori molto raffinati.

Il tocco personale è così incisivo che tanti dei loro oggetti trovano subito un inatteso, ma tanto meritato riscontro tra gli amanti dei prodotti dello stile classico di alto livello.

La clientela, case nobili italiane ed europee, artisti, collezionisti d'arte e soprattutto designer d'interni si lascia ispirare e colloca i primi pezzi di Pataviumart in ambienti di alto prestigio. Quanto più cresce la quantità di lavoro, tanto più si ingrandisce la società. Nel 1971 ci trasferiamo a Villa Wollemborg a Loreggia, da allora sede stabile ed inconfondibile della azienda.

Gli spazi sono cresciuti, le collezioni si diversificano, i mercati esteri bussano fortemente all'antico cancello della nuova sede. Il Belgio, i Paesi Bassi, la Francia e la Germania ci permettono i primi passi sulla scena internazionale.

Collezioni uniche create con capacità espressiva, stili inconfondibili e una qualità impeccabile conquistano ed appassionano clienti in sempre più paesi. Il lavoro è tanto, ma altrettante sono la dedizione e la passione che caratterizzano l'attività dei fondatori e di tutti gli artigiani della Pataviumart. Dopo la scomparsa di Adriano nel 1984 entra nella società la figlia Simonetta, nuovo titolare e, come il padre, cuore artistico dell'impresa. La sua mano crea oggetti di illuminazione che trascendono da ogni stereotipo; il vetro di Murano, il cristallo, i marmi, gli alabastrini, le perle di vetro entrano nel design degli articoli.

Colori si abbinano, si contrastano, si mescolano. Stili si fondono, rinascono nuovi, innovativi, e... emozionano! Chandeliers, lampade da tavolo, piantane, plafoniere ed appliques sposano paralumi che, come il vetro di Murano o il cristallo stessi, hanno il potere a volte di catturare, a volte di trasmettere, ma sempre di interpretare splendidamente la luce ed il suo colore.

Alle fine del secondo millennio, nuovi mercati si affacciano; tanto è il fascino che questi articoli diffondono. I Paesi Arabi, la Russia, la Cina, la Corea... paesi così numerosi che l'azienda decide di incrementare il suo potenziale imprenditoriale accogliendo Mayc R.Letzner tra i suoi partners. Si forma così il gruppo dirigenziale attuale che, malgrado la sua giovane età, vanta una notevole esperienza, un team affiatato per creatività ed innovazione, vibrante di energia, pieno di entusiasmo per gli attuali e futuri progetti, ricco di idee e sogni, quei sogni, che più di 40 anni fa avevano segnato l'inizio della avventura...

## AN ADVENTURE WHICH HAS BEGAN IN 1959

Back in 1959 nobody, not even Adriano Gomiero or Ines Piccolo themselves, could have imagined what they would have achieved.

So remote seems that year, so distant and so unfamiliar the way of life of that period with its different habits, customs, attitudes, modes and tastes. However, the youthful Adriano and Ines were full of the dreams, the hopes, the optimism, the creativity and the inner strength so typical of the young. It is here, in these determined and strong characters, filled with confidence in their abilities, strength and dedication, in their devotion that we find the first idea of our Pataviumart, one of the most pre-eminent luxury lighting design companies of today.

They were in love, hungry for life, with the desire to create, to give space and expression to their ideas, their ideal of beauty and their insistent dream to produce objects which would transmit all this to others. Adriano, with an innate artistic talent and the optimism of a dreamer, sensitive and emotional, admired the perfection of the great classic Italian and European Masters of Arts; Ines, with a strong and determined character, accompanied by the natural gentleness of a loving woman, was a brilliant organizer with a razor-sharp sense of practicality. Both felt that they had to establish and develop their own company to make their dreams come true. This way, their dream of yesterday has become today's reality of ours...

Adriano, a craftsman almost from birth, student and Master of Arts later, started to develop, together with his wife Ines, the first Collection of lighting objects of Pataviumart in its first premises in Padua (lat. "Patavium"), a historical Italian city known for its famous traditions in arts and craftsmanship and as such inspiration for the name of the company.

Based on antique and historical works, the lamps and chandeliers of Pataviumart are skilfully redesigned, recreated and afterwards perfected with craftsmanship beyond comparison.

Adriano and Ines exclusively follow antique methods such as the 'earth-casting' used for the production of the metal and brass structures and frames of each article. Every single object is subsequently completed with gorgeous and incredibly refined lamp-shades or sophisticated accessories. Their personal style and touch is so decisive that many of their objects immediately obtain a long-desired but yet unexpected acknowledgment among the admirers and collectors of unique, prestigious objects of classical style.

The clientele, noble Italian and European houses, artists, collectors of fine arts and especially interior designers are so inspired that they place the first pieces of Pataviumart in highly prestigious ambiances. The workload grows, and the company grows apace.

In 1971 the company moves to Villa Wollemborg, Loreggia which becomes its new home.

The premises have grown and the Collections become more and more diversified and distinct. International market buyers knock on Pataviumart's antique gate. Customers in Belgium, the Netherlands, France and Germany give us our first taste of the international market scene. Unique Collections designed and created with unequalled passion, unparalleled style and unrivalled quality conquer and charm customers in a continuously growing number of countries. Much is the work but even greater is the devotion and the fervour which distinguish the commitment of the founders and the numerous artisans and craftsmen of Pataviumart.

After Adriano's death in 1984, his daughter Simonetta enters the company.

Simonetta, like her father before her, becomes the artistic heart of the enterprise. Her talent creates lighting objects which transcend any stereotype; Venetian Murano glass, crystal, marble, alabaster and glass pearls make their appearance in the designs of our Collections. Colours shade, merge and contrast.

Styles mix, mutate and... excite! Table, floor and ceiling lamps, chandeliers, appliques and wall sconces melt with shades, which like the Murano glass or the crystals themselves, have the power to sometimes capture, sometimes to transmit but always to marvellously interpret light and its colours. At the end of the second millennium, new markets appear, such is the fascination that these articles provoke.

The Arab countries, Russia, China, Korea... countries so numerous that the company decides to welcome Mayc R.Letzner among its partners to improve its strategic potential; a managing team has formed which though young, boasts a superb experience.

A close, creative and vibrant team, full of energy, innovation and enthusiasm for current and future projects, full of ideas and dreams.

Dreams just like the ones which marked the beginning of our adventure about forty years ago ...

VILLA  
WOLLEMBORG





Villa Polcastro, Loreggia 1544



Villa Polcastro, Loreggia 1867 - Olio su tela, cm 67x102  
Villa Polcastro, Loreggia 1867 - Oil on canvas, cm 67x102



Araldo della famiglia Polcastro  
The crest of the Polcastro family



Girolamo Polcastro

## LA STORIA

Registrata nei documenti ufficiali da Girolamo Polcastro nel 1544, la sede di Pataviumart vanta una storia lunga e, come quella della azienda stessa, da sempre strettamente legata al pensiero artistico e filosofico italiano.

Sin dalla sua storica nascita nella prima metà del Cinquecento, Villa Polcastro, più tardi Villa Wollemborg, svolgeva un ruolo importante e centrale nella vita dei suoi proprietari.

Nel Quattrocento, Sigismondo Polcastro, noto professore e medico padovano appartenente ad una delle famiglie più conosciute ed imparentate con le più nobili dinastie della città, acquistò molti beni nel territorio padovano ed anche a Loreggia. Lì, all'inizio del secolo successivo, risulta già costruita una villa dominicale. Inizialmente fu utilizzata come casa di villeggiatura.

Dopo l'allargamento della barchessa con l'aggiunta di una nuova ala ad est alta ben quattro piani, di un brolo all'interno del muro di cinta legati alla torre colombara ed una cedaia già esistenti, il complesso divenne un palazzo rappresentativo di dimensioni importanti.

Furono fatti così, all'inizio del Seicento, i primi progetti per lo sviluppo dell'ambiente intorno alla villa. Questi piani compresero la creazione di un laghetto a quei tempi rettangolare, che all'inizio dell'Ottocento, fu modificato da Giuseppe Jappelli, famoso architetto ed amico del Conte Girolamo Polcastro.

L'ultimo, forse l'esponente più illustre dei Polcastro, divenne famoso per la sue convinzioni sulla necessità di un radicale cambiamento della società; era affascinato dalla rivoluzione francese ed ispirò la sua rilevante azione politica alle idee giacobine.

Nei primi decenni del XIX secolo Girolamo Polcastro fece ristrutturare tutta la villa in maniera sostanziale e fu in quel periodo che l'edificio prese allora l'aspetto che ancora conserva, quello di un bel palazzo classicheggiante nella parte più occidentale, con ampia facciata a sud verso il giardino all'italiana e l'ala orientale secentesca addossata al nuovo corpo.

La Villa è circondata da un parco lussureggiante, ideato nel suo aspetto da Giuseppe Jappelli riprendendo l'idea del giardino romantico dall'inglese Lancelot Brown.

L'architetto italiano ne fece una accurata progettazione elaborando sia i percorsi delle acque sia quelli del passaggio. Durante la sua costruzione tra il 1829 ed il 1833 il preesistente lago rettangolare fu trasformato rendendolo irregolare; furono create alcune montagnole, piantate centinaia di alberi e lunghe siepi acquistate a Saonara.

Si aggiunsero giochi d'acqua ed una decina di ponticelli rustici per l'attraversamento dei canali e del lago, dove vennero innalzate delle isolette. Oggi quindi, una fitta rete di sentieri permette di passare nel folto dell'ombra per riparare dal caldo o da eventuali venti freddi nell'inverno.

Attraverso l'improvvisa apparizione e scomparsa del panorama, di barriere arboree, di aperture sconfiniate, di luci e ombre, di essenze esotiche, rare e di variopinte coloriture il giardino suggerisce la variabilità dei sentimenti facendo in questo modo nascere il senso del "sublime", olimpo non solo del pensiero filosofico ed artistico. Quale contesto migliore per la creazione di oggetti d'arte, di forme che incantano, che interpretano e re-interpretano la luce, i colori, il design!

Un ambiente prestigioso, animato dalla filosofia, dalla storia e dalla storia d'arte di questo paese, con un respiro pulito, chiaro, sublime, punto di partenza per ogni pensiero, ogni sentimento, ogni oggetto di bellezza rara, come quelli legate alle creazioni di Pataviumart.

Fu questo il pensiero di Adriano e Ines, quando, nel 1971 acquistarono il complesso per trasferirci la loro vita e la loro azienda. Oggi è anche grazie a questa sintonia che noi possiamo trovare il luogo e l'ispirazione per la nostra passione...

## THE HISTORY

Registered in the official documents in 1544 by Girolamo Polcastro, the home of Pataviumart, has a long history which has always been, as the company itself, closely connected to Italy's artistic and philosophical thought. Since its construction during the first half of the fifteenth century Villa Polcastro, later Villa Wollemborg, has played an important and central role in the life of its owners.

In the fourteenth century Sigismondo Polcastro, a famous professor and physician of Padua who belonged to one of the best known noble families of the area, purchased many holdings in the surrounding areas of the town, among them land in Loreggia. Here, at the beginning of the sixteenth century, we can already find the records of a Sunday villa mainly used as a place of relaxation at the weekends.

After adding an annex (the Barchesse) to the building, along with a new east wing of four floors and an internal garden within the walls linked to the tower and the already existing citron-tree grove, the complex became a palace of considerable dimensions.

It is during this period, at the beginning of the sixteenth century, that the first projects for the development of the environment around the villa were made. These projects included the creation of a rectangular lake which, at the start of the eighteenth century, was modified by Giuseppe Jappelli, a famous architect and friend of Count Girolamo Polcastro.

The latter, most probably the most distinguished member of the Polcastro family, became prominent for his ideas about the necessity of radical change in society. In fact, he was fascinated by the French revolution, and Jacobean thoughts guided his outstanding political career. Girolamo Polcastro, during the first decades of the nineteenth century, had the Palace entirely restructured and it was in this era, that the villa obtained its current look.

Today it appears as a beautiful classical palace with a broad façade towards the Italian garden in the south and the sixteenth century east wing next to the main building.

The villa is surrounded by a lovely park, conceived by Giuseppe Jappelli revising the Englishman Lancelot Brown's ideas of a romantic English garden. The Italian architect developed an accurate project determining both water courses and walks.

During their construction between 1829 and 1833 the shape of the pre-existing rectangular lake was changed into an irregular one; small hillocks were created and hundreds of trees and long hedges brought from Saonara were planted. Water courses were added and a dozen wooden bridges were built across the canals and the lake to connect the walks to the small islands raised in its middle.

Today a dense network of romantic walks and paths allows visitors to wander through the cool shadows during summer and to appreciate their protection from the cold winds in winter.

Lovely views open among the arboreal barriers, endless spaces appear and vanish, light and shadow melt with exotic essence. Rare and multicoloured plants and flowers reflect the variability of feelings and subtle sensation give way to the rise of the 'sublime', Olympus not only of the philosophical and artistic thought. What perfect surroundings for the creation of objects of art, of forms and shapes that generate emotions, that interpret and reinterpret light, colours and design!

A prestigious ambience, inspired by philosophy, history and the history of art in this country; a clear and clean breath, a sublime starting point of thoughts, ideas, feelings – prerequisite conditions for the creation of objects of rare beauty as those designed by Pataviumart.

These were the thoughts of Adriano and Ines in distant 1971 when they decided to move their lives and their company to this enchanted place. Today, it is thanks to this harmony that we can find the place for our inspiration and passion...

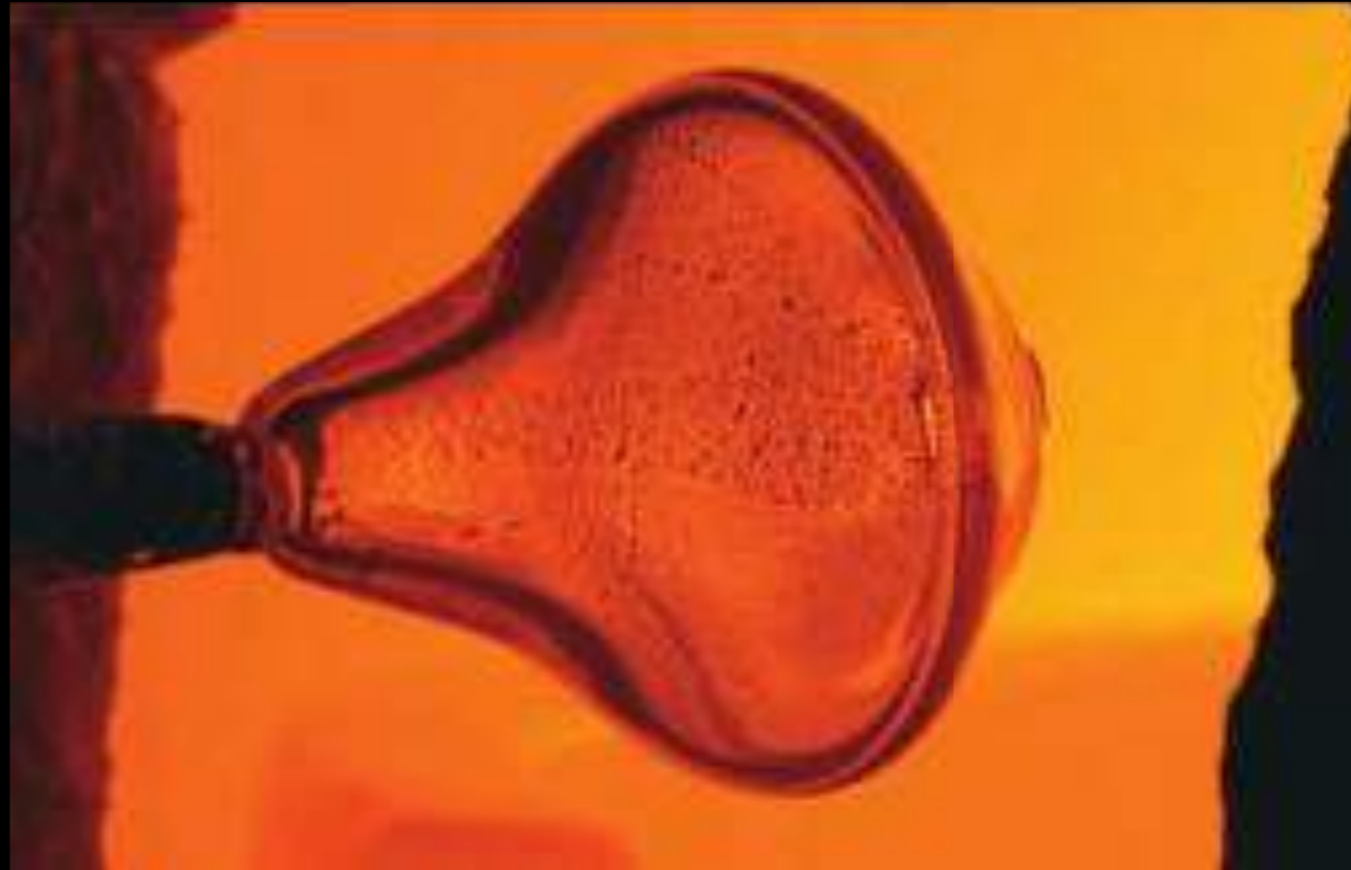

## OPERE D'ARTE IN VETRO SOFFIATO

Arte è bellezza, è rivelazione, è ricerca dell'ego, del vero ma anche del sublime, è un riflesso interiore. Design significa forma, linea, interazione con l'ambiente, funzionalità... Il colore è una delle caratteristiche della luce, ma anche la sua interpretazione e visualizzazione.

Arte, design e colori nascono da e con emozioni, da e con sensazioni e sono loro che se ne riflettono.

Essi rispecchiano la personalità, lo stile e lo stile di vita.

Fanno parte del quotidiano, del reale, del visibile, ma essi sono pur sempre distaccabili, un complesso ed intrigante esercizio mentale, sentimento puro o divertimento.

Niente è concepibile senza di essi, ma il grado della loro presenza nella vita di ognuno è strettamente personale.

Arte, design e colore sono quindi forme di espressione del mondo culturale, sociale ed intellettuale di ogni singolo individuo e come tali risultato di pensieri, di sogni, magari di un'analisi interiore profonda o di una scelta determinata dal gusto.

E per i loro ideatori e creatori rappresentano un immenso impegno di duro lavoro...

Noi, in Pataviumart, questo lo sappiamo. Lo sentiamo. Lo sentivano i nostri fondatori e lo volevano condividere, divulgare, rendere accessibile a tanti. Ma non a tutti. La ricerca della realizzazione dei sogni, della scoperta del vero, del veramente bello, dell'affascinante, dell'emozionante fa parte di noi in Pataviumart e noi le diamo spazio. Le diamo forma, colore e design.

Creiamo delle realtà dando forma ai nostri sogni. Difficile immaginare un'attività più appagante ed è con grandissima soddisfazione che abbiamo potuto constatare che tanti degli oggetti da noi ideati vengono considerati veri e propri oggetti d'arte.

Un traguardo questo raggiunto dopo un lungo e tortuoso processo di analisi, di progettazioni e di realizzazioni artistiche senza compromessi; un traguardo che rappresenta sempre un nuovo punto di partenza.

Nascono così le idee per i nostri chandeliers, le nostre lampade, le piantane o le plafoniere, dal desiderio di creare un oggetto che continui la nostra storia, che la racconti e con essa, quella di un'arte antica, arte nata e cresciuta nei secoli nelle manifatture dei vetrai veneziani, muranensi ed in quelle delle fonderie padovane.

Raffinati dovevano e devono essere i nostri articoli, trasmettere ed amplificare atmosfere, amalgamarsi con l'ambiente nel quale vengono collocati rimanendo pur sempre protagonisti, senza perdere il loro carattere, il loro fascino, senza nascondere la propria presenza.

Anzi. Ed è per questo che essi per lo più si collocano in prestigiosi palazzi, sontuose ville, illustri teatri e famosi alberghi, in ampi foyers, sale da ricevimento secolari, classiche o di design moderno, sale da pranzo, gallerie, studi, camere da notte e da bagno.

## OBJECTS OF ART IN BLOWN GLASS

Art is beauty, revelation, the search for the self, the truth and the sublime. Art is an interior reflection. Design means form, shape, interaction with the surroundings; it means functionality. Colour is one of the characteristics of light, but also its interpretation and visualization. Art, design and colour emerge from emotions, from and with the sensations they reflect.

They express personality, elegance and life style. They are part of the daily life, of the visible, the tangible, but at the same time they are remote; they are a complex and intriguing mental exercise, a pure feeling or just plain fun. Nothing can be conceived without them but the extent of their presence in the life of each individual is merely personal. Art, design and colour are therefore an expression of the cultural, social and intellectual world of every person and as such the result of thoughts, ideas, dreams and, perhaps, of a profound interior analysis or of choices determined by taste. In any case, from those who conceive and create them they require an immense and constant commitment to their work...

We at Pataviumart know this. We feel it every day. Our founders felt it and they wanted to share it, to reveal it, to make it accessible to others. To many, but not to all.

Our desire to make our dreams come true through the discovery of the really beautiful, the fascinating, enchanting and captivating soul of a piece of art has always been the mainspring for us at Pataviumart. It is an intrinsic part of our work and as such we have always tried to leave it scope. We have given it shape, colour and design, creating reality from our ideas and dreams.

It is nearly impossible to imagine an activity which could give you more satisfaction than this. Proud and satisfied were we when customers referred to our products as ravishing pieces of art; a goal met after a long and tortuous period of analysis, design and artistic development, without compromise.

But as every arrival contains a new beginning, achieved objectives generate new ones. And that is how the ideas for our new chandeliers, table, floor and ceiling lamps, appliques and wall-sconces are born, how they materialize and become part of a history intertwined with antique arts and craftsmanship perfected over centuries in Padua's foundries and the workshops of glass blowers from Murano and Venice. Sophisticated and refined must our articles be.

They have to charm, to create or emphasize atmospheres and to merge with the environment in which they are introduced without losing their character and appeal, without hiding their presence. On the contrary!

And it is exactly for these characteristics that our products are placed in prestigious palaces, gorgeous villas, famous theatres and luxurious hotels, in wide foyers and concert halls, salons with classical and contemporary designs alike, dining rooms, galleries or stylish lounges.



## OPERE D'ARTE CUCITE A MANO

Infiniti sono oggi gli spazi impreziositi dalle nostre creazioni, infiniti, come le variazioni dei designs, degli stili, dei colori, delle misure e delle rifiniture dei nostri articoli.

La nostra attuale Collezione comprende più di dieci mila varianti-articoli, ognuna di queste concepita per incantare lo spettatore... Troverete, quindi nei vari capitoli, divisi per tipologia, una selezione di singoli oggetti, che rappresentano al meglio le nostre varie collezioni.

L'imparagonabile qualità artistica e produttiva, in tutti i casi criterio immutabile per il nostro lavoro, contraddistingue ognuno di essi. Materiali preziosi come il vetro di Murano, i Cristalli Swarovski® o Asfour, l'alabastro, i marmi, le perle e le porcellane di Capodimonte di purezza rara, l'ottone e preziosi metalli di manifattura artigianale, la cui creazione viene eseguita esclusivamente secondo tecniche antiche come la fusione a terra, formano la base irrinunciabile della nostra produzione.

Paralumi di seta purissima e di tessuti pregiatissimi, a volte ricamati o ulteriormente impreziositi da perle di vetro o da cristalli Swarovski®, gioielli o fiori di conteria, intensificano il potere di catturare, fondere o colorare la luce dei nostri oggetti di illuminazione.

Tutte le fasi della loro creazione sono soggette ad un costante e dettagliato controllo della qualità; qualità che ha notevolmente contribuito alla nostra indiscussa reputazione nel mercato mondiale. LasciateVi quindi impressionare. Sfogliate le pagine ed ammirate la bravura dei nostri artigiani. Troverete oggetti unici per il loro design, unici per la loro bellezza, per il loro stile, per le loro combinazioni e per le sfumature dei colori nonché per il sapiente abbinamento delle rifiniture. Troverete oggetti di altissimo prestigio creati singolarmente da mani artigiane esperte, prodotti che sono irripetibili, mai uguali.

Variazioni nei colori dei vetri, del cristallo o delle rifiniture sono inevitabili così come sono inevitabili piccole differenze di misura o di forma. Considerate quindi le misure con un minimo di approssimazione.

Appreziate il valore aggiunto che ne consegue per ogni singolo oggetto. Vestite i Vostri Ambienti con la loro bellezza, sfruttate la Luce, la sua intensità ed il suo colore a Vostro piacere, create ambienti che rispecchiano la Vostra personalità.

Azzardate la bellezza, l'arte, il prestigio, il lusso! Trasformate il Vostro sogno in realtà. Come facciamo noi in Pataviumart.



## OBJECTS OF ART ENTIRELY HAND-MADE

The number of locations embellished by our creations is infinite as the facets of their designs, their styles, their colours and their sizes.

Our current Collection contains more than ten-thousand article-varieties, each of which is conceived to charm the spectator. In the various chapters you will find, separated according to typology, a selection of single objects which represent our different Collections at their best. Each of them stands out for its unrivalled artistic quality and craftsmanship, ever the creed and criterion of our work.

Precious materials as blown Murano glass, Swarovski® or Asfour crystals, alabaster, marble, pearls and Capodimonte porcelains of rare perfection, brass and precious metals, silver-plated or gilded and still today cast 'in earth' using traditional moulds are the basis of our production. Lamp shades made of silk of extremely rare purity and sophisticated fine fabrics, sometimes embroidered or enriched with glass pearls, Swarovski® crystals, jewels or glass bead flowers intensify the lamp shades' power to capture, to reflect, to merge and to colour the light of our lamps.

All phases of their creation and production are subject to a constant and detailed quality control.

Without doubt, this exceptional quality has considerably contributed to our superb reputation on the world market. Therefore, let us enchant you! Leaf through these pages and admire the unsurpassed mastery of our craftsmen; you will find objects and items unique for their designs, their beauty, their style, their virtually inexhaustible diversity of form or for their charmingly matched colours and finishes.

You will find unmistakable icons of our brand made piece by piece by our craftsmen's expert touch; singular objects, unrepeatable, unique. Variations in the shades of the Murano glass, the crystals, the finishes and the fine fabrics are inevitable as are inevitable small differences in size and shape.

Therefore appreciate the additional value that derives from the craftsmanship that goes into every single piece. Enrich your surroundings with their beauty and let them generate in you sensory and emotional experiences. Use their light, its intensity or softness, its colours to create for you an intimate and special place, your home. Let us tempt you to design surroundings which reflect your personality. Dare to indulge yourself in beauty, art, glamour and luxury! Transform your dreams into reality. As we do, at Pataviumart.





APPLIQUES



TYPE	CODE	SIZE
	AP0664/01	cm 16xh24x30

	TL0662/01	cm 30xh47
---	-----------	-----------

**AP0664/01AC**  
**COP005779825003**

TYPE

CODE

SIZE



AP1050/02	cm 47xh39x21
AP1050/03	cm 52xh43x23
AP1050/07	cm 65xh112x26



CH1050/05	cm 50xh65
-----------	-----------

G0=A0&D0	H9=A3&D4
G1=A0&D1	I0=A4&D0
G3=A0&D3	I1=A4&D1
G4=A0&D4	I3=A4&D3
G5=A1&D0	I5=A5&D0
G8=A1&D3	I6=A5&D1
H2=A2&D2	I7=A5&D2
H4=A2&D4	I8=A5&D3
H6=A3&D1	I9=A5&D4
H7=A3&D2	



AP1050/03NAGO  
VDS002833

TYPE

CODE

SIZE



AP1050/02	cm 47xh39x21
AP1050/03	cm 52xh43x23
AP1050/07	cm 65xh112x26



CH1050/05	cm 50xh65
-----------	-----------

G0=A0&D0	H9=A3&D4
G1=A0&D1	I0=A4&D0
G3=A0&D3	I1=A4&D1
G4=A0&D4	I3=A4&D3
G5=A1&D0	I5=A5&D0
G8=A1&D3	I6=A5&D1
H2=A2&D2	I7=A5&D2
H4=A2&D4	I8=A5&D3
H6=A3&D1	I9=A5&D4
H7=A3&D2	



A0 A1 A2 A3 A4 A5



D0 D1 D2 D3 D4 D5 D7

AP1050/03NCI7  
VSS001847

TYPE

CODE

SIZE



AP1050/02	cm 47xh39x21
AP1050/03	cm 52xh43x23
AP1050/07	cm 65xh112x26



CH1050/05	cm 50xh65
-----------	-----------

G0=A0&D0	H9=A3&D4
G1=A0&D1	I0=A4&D0
G3=A0&D3	I1=A4&D1
G4=A0&D4	I3=A4&D3
G5=A1&D0	I5=A5&D0
G8=A1&D3	I6=A5&D1
H2=A2&D2	I7=A5&D2
H4=A2&D4	I8=A5&D3
H6=A3&D1	I9=A5&D4
H7=A3&D2	



A0 A1 A2 A3 A4 A5



D0 D1 D2 D3 D4 D5 D7



AP1050/07NAI9  
VSS001916

TYPE

CODE

SIZE

AP1050/02	cm 47xh39x21
AP1050/03	cm 52xh43x23
AP1050/07	cm 65xh112x26

CH1050/05	cm 50xh65
-----------	-----------

G0=A0&D0	H9=A3&D4
G1=A0&D1	I0=A4&D0
G3=A0&D3	I1=A4&D1
G4=A0&D4	I3=A4&D3
G5=A1&D0	I5=A5&D0
G8=A1&D3	I6=A5&D1
H2=A2&D2	I7=A5&D2
H4=A2&D4	I8=A5&D3
H6=A3&D1	I9=A5&D4
H7=A3&D2	



AP1050/07NCD3  
COP002839

TYPE

CODE

SIZE



AP1050/02	cm 47xh39x21
AP1050/03	cm 52xh43x23
AP1050/07	cm 65xh112x26



CH1050/05	cm 50xh65
-----------	-----------

G0=A0&D0	H9=A3&D4
G1=A0&D1	I0=A4&D0
G3=A0&D3	I1=A4&D1
G4=A0&D4	I3=A4&D3
G5=A1&D0	I5=A5&D0
G8=A1&D3	I6=A5&D1
H2=A2&D2	I7=A5&D2
H4=A2&D4	I8=A5&D3
H6=A3&D1	I9=A5&D4
H7=A3&D2	



AP1050/07NCI6  
VSS001903

TYPE CODE SIZE



AP1850/02	cm 42xh50x20
AP1850/03	cm 50xh52x26



CH1850/06	cm 65xh75
CH1850/08	cm 80xh85
CH1850/10	cm 85xh90
CH1850/12	cm 95xh120
CH1850/18	cm 110xh130
CH1850/M3	cm 32xh56
CH1850/M6	cm 47xh55



CL1850/04	cm 55xh50
-----------	-----------



FL1850/06	cm 50xh180
-----------	------------







TL1850/06	cm 47xh79
-----------	-----------



AP1850/02NG30  
COS002908



TYPE	CODE	SIZE
	AP1920/02	cm 35xh48x19
	CH1920/05	cm 50xh70
	CH1920/08	cm 74xh88
	CL1920/04	cm 55xh50
	FL1920/05	cm 50xh180
	TL1920/04	cm 45xh83



AP1920/02NG30A1  
COS002908



CHANDELIERS

TYPE

CODE

SIZE



AP1000/02 cm 35xh35x26



CH1000/12 cm 140xh170



24  
multi-colour mix



32



35



CH1000/1232

TYPE

CODE

SIZE



AP1050/02 cm 47xh39x21

AP1050/03 cm 52xh43x23

AP1050/07 cm 65xh112x26



CH1050/05 cm 50xh65



D0

D1

D2

D3

D4

D5

D7

CH1050/05NID3  
COS003763752839

TYPE

CODE

SIZE

AP1800/02	cm 42xh50x20
AP1800/03	cm 50xh52x26

CH1800/06	cm 60xh80
CH1800/08	cm 80xh85
CH1800/10	cm 85xh95
CH1800/12	cm 95xh120
CH1800/18	cm 110xh140
CH1800/M3	cm 32xh56
CH1800/M6	cm 47xh55

CL1800/04	cm 55xh50
-----------	-----------

FL1800/06	cm 50xh180
-----------	------------

TL1800/06	cm 47xh79
-----------	-----------





**CH1800/M6NG**  
COP002839

TYPE	CODE	SIZE
	AP1820/02	cm 42xh50x20
	AP1820/03	cm 50xh52x26

	CH1820/06	cm 60xh65
	CH1820/08	cm 75xh75
	CH1820/10	cm 85xh85
	CH1820/12	cm 95xh95
	CH1820/18	cm 110xh110
	CH1820/M3	cm 32xh56
	CH1820/M6	cm 47xh55

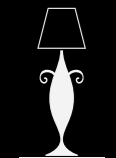
	CL1820/04	cm 55xh50
---	-----------	-----------

	FL1820/06	cm 50xh180
--	-----------	------------

	TL1820/06	cm 47xh79
---	-----------	-----------



**CH1820/06NG30**  
COS003908

TYPE

CODE

SIZE



AP1830/02	cm 42xh50x20
AP1830/03	cm 50xh52x26



CH1830/06	cm 60xh80
CH1830/08	cm 78xh85
CH1830/10	cm 85xh95
CH1830/12	cm 95xh120
CH1830/18	cm 110xh140
CH1830/M3	cm 32xh56
CH1830/M6	cm 47xh55

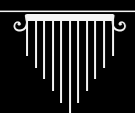

CL1830/04	cm 55xh50
-----------	-----------

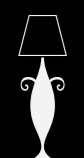

FL1830/06	cm 50xh180
-----------	------------



TL1830/06	cm 47xh79
-----------	-----------



**CH1830/06NE**  
COS003907

TYPE

CODE

SIZE



AP1831/02	cm 42xh50x20
AP1831/03	cm 50xh52x26



CH1831/06	cm 60xh80
CH1831/08	cm 78xh85
CH1831/10	cm 85xh95
CH1831/12	cm 95xh120
CH1831/18	cm 110xh140
CH1831/M3	cm 32xh56
CH1831/M6	cm 47xh55



CL1831/04	cm 55xh50
-----------	-----------



FL1831/06	cm 50xh180
-----------	------------



TL1831/06	cm 47xh79
-----------	-----------



CH1831/M3NC10



TYPE

CODE

SIZE

AP1840/02	cm 42xh50x20
AP1840/03	cm 50xh52x26

CH1840/06	cm 60xh80
CH1840/08	cm 78xh85
CH1840/10	cm 85xh95
CH1840/12	cm 95xh120
CH1840/18	cm 110xh140
CH1840/M3	cm 32xh56
CH1840/M6	cm 47xh55

CL1840/04	cm 55xh50
-----------	-----------

FL1840/06	cm 50xh180
-----------	------------

TL1840/06	cm 47xh79
-----------	-----------



**CH1840/10NC**  
COS003907

TYPE CODE SIZE



AP1850/02	cm 42xh50x20
AP1850/03	cm 50xh52x26



CH1850/06	cm 60xh75
CH1850/08	cm 80xh85
CH1850/10	cm 85xh90
CH1850/12	cm 95xh120
CH1850/18	cm 110xh130
CH1850/M3	cm 32xh56
CH1850/M6	cm 47xh55



CL1850/04	cm 55xh50
-----------	-----------

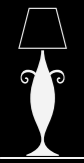

FL1850/06	cm 50xh180
-----------	------------



TL1850/06	cm 47xh79
-----------	-----------



CH1850/08NF25  
COS003704843

TYPE CODE SIZE



AP1850/02	cm 42xh50x20
AP1850/03	cm 50xh52x26



CH1850/06	cm 60xh75
CH1850/08	cm 80xh85
CH1850/10	cm 85xh90
CH1850/12	cm 95xh120
CH1850/18	cm 110xh130
CH1850/M3	cm 32xh56
CH1850/M6	cm 47xh55



CL1850/04	cm 55xh50
-----------	-----------



FL1850/06	cm 50xh180
-----------	------------



TL1850/06	cm 47xh79
-----------	-----------

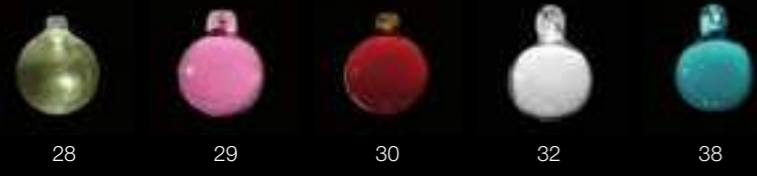

CH1850/10NA01  
COS003906

TYPE CODE SIZE



AP1850/02	cm 42xh50x20
AP1850/03	cm 50xh52x26



CH1850/06	cm 60xh75
CH1850/08	cm 80xh85
CH1850/10	cm 85xh90
CH1850/12	cm 95xh120
CH1850/18	cm 110xh130
CH1850/M3	cm 32xh56
CH1850/M6	cm 47xh55



CL1850/04	cm 55xh50
-----------	-----------



FL1850/06	cm 50xh180
-----------	------------



TL1850/06	cm 47xh79
-----------	-----------

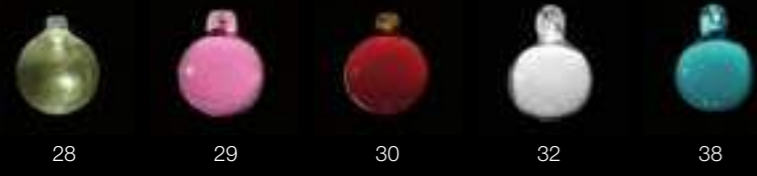

CH1850/18NG30  
COS003908

TYPE	CODE	SIZE
	AP1860/02	cm 42xh50x20
	AP1860/03	cm 50xh52x26

	CH1860/06	cm 60xh80
	CH1860/08	cm 80xh85
	CH1860/10	cm 85xh95
	CH1860/12	cm 95xh120
	CH1860/18	cm 110xh140
	CH1860/M3	cm 32xh56
	CH1860/M6	cm 47xh55

	CL1860/04	cm 55xh50
--	-----------	-----------

	FL1860/06	cm 50xh180
---	-----------	------------

	TL1860/06	cm 47xh79
---	-----------	-----------



**CH1860/06NE08**  
**COS003910**

TYPE

CODE

SIZE



AP1880/02	cm 42xh50x20
AP1880/03	cm 50xh52x26



CH1880/06	cm 65xh90
CH1880/08	cm 80xh100
CH1880/10	cm 85xh110
CH1880/12	cm 95xh120
CH1880/18	cm 110xh150



CL1880/04	cm 55xh50
-----------	-----------



FL1880/06	cm 50xh180
-----------	------------



TL1880/06	cm 47xh79
-----------	-----------



**CH1880/08NL**  
COS003902

TYPE

CODE

SIZE



AP1882/02	cm 42xh50x20
AP1882/03	cm 50xh52x26



CH1882/06	cm 65xh90
CH1882/08	cm 80xh100
CH1882/10	cm 85xh110
CH1882/12	cm 95xh120
CH1882/18	cm 110xh150



CL1882/04	cm 55xh50
-----------	-----------



FL1882/06	cm 50xh180
-----------	------------



TL1882/06	cm 47xh79
-----------	-----------



02      22      25      30



**CH1882/08NC30**  
**COS003908**

TYPE

CODE

SIZE



AP1883/02	cm 42xh50x20
AP1883/03	cm 50xh52x26



CH1883/06	cm 65xh90
CH1883/08	cm 80xh100
CH1883/10	cm 85xh110
CH1883/12	cm 95xh120
CH1883/18	cm 110xh150



CL1883/04	cm 55xh50
-----------	-----------



FL1883/06	cm 50xh180
-----------	------------



TL1883/06	cm 47xh79
-----------	-----------



01      02      08      25      28

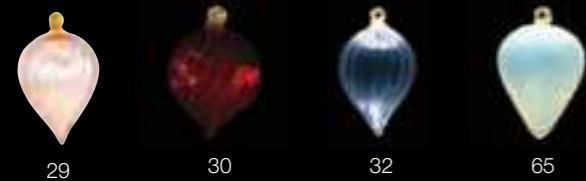

29      30      32      65

05=02+30  
33=01+32  
35=28+32  
36=29+32  
40=01+29+32  
41=08+29  
44=08+32



**CH1883/08NJ36**  
**COS003847**



TYPE

CODE

SIZE



AP1885/02	cm 42xh50x20
AP1885/03	cm 50xh52x26



CH1885/06	cm 65xh90
CH1885/08	cm 80xh100
CH1885/10	cm 85xh110
CH1885/12	cm 95xh120
CH1885/18	cm 110xh150



CL1885/04	cm 55xh50
-----------	-----------



FL1885/06	cm 50xh180
-----------	------------



TL1885/06	cm 47xh79
-----------	-----------



**CH1885/10NC**  
COS003901

TYPE

CODE

SIZE



AP1900/02	cm 42xh50x20
AP1900/03	cm 50xh52x26



CH1900/06	cm 60xh80
CH1900/08	cm 80xh85
CH1900/10	cm 85xh95
CH1900/12	cm 95xh120
CH1900/18	cm 110xh140
CH1900/M3	cm 32xh56
CH1900/M6	cm 47xh55



CL1900/04	cm 55xh50
-----------	-----------







FL1900/06	cm 50xh180
-----------	------------



TL1900/06	cm 47xh79
-----------	-----------







**CH1900/08NG**  
COS003907

TYPE	CODE	SIZE
	AP1920/02	cm 35xh48x19
	CH1920/05	cm 50xh70
	CH1920/08	cm 74xh88
	CL1920/04	cm 55xh50
	FL1920/05	cm 50xh180
	TL1920/04	cm 45xh83



**CH1920/05NC29A3**  
**COS003848**

TYPE	CODE	SIZE
	AP1920/02	cm 35xh48x19
	CH1920/05	cm 50xh70
	CH1920/08	cm 74xh88
	CL1920/04	cm 55xh50
	FL1920/05	cm 50xh180
	TL1920/04	cm 45xh83



**CH1920/08NA08A2**  
COS003909

TYPE

CODE

SIZE



AP1930/02 cm 42xh50x20



CH1930/04 cm 52xh60

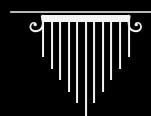

CL1930/04 cm 55xh50



FL1930/04 cm 50xh180



TL1930/04 cm 45xh57



**CH1930/04NI**  
COS002707843



**TYPE**      **CODE**      **SIZE**



CH2000/12      cm 60xh80











**CH2000/12NG30**

TYPE	CODE	SIZE
	CH2222/06	cm 88xh110
	CH2222/08	cm 94xh130
	CH2222/10	cm 105xh135
	CH2222/12	cm 115xh150

	FL2222/06	cm 50xh180
---	-----------	------------



	TL2222/06	cm 47xh79
---	-----------	-----------

					
01	02	08	25	28	
					05=02+30 33=01+32 35=28+32 36=29+32 40=01+29+32 41=08+29 44=08+32
29	30	32	65		



**CH2222/08NJ36**  
COP005823104



TYPE	CODE	SIZE
	AP3100/03	cm 34xh42x20
	CH3100/18	cm 75xh93

Modello disponibile anche elettrificato  
Model also electrified

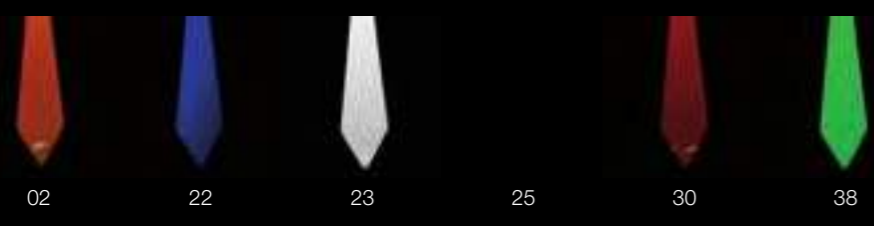



**CH3100/18NF25**





**TYPE** **CODE** **SIZE**

 AP3300/03 cm 52xh80x30

 CH3300/12 cm 128xh130  
 CH3300/20 cm 180xh170  
 CH3300/40 cm 250xh285



 FL3300/06 cm 55xh190

 TL3300/07 cm 54xh102



**CH3300/20NA33**  
**COS009906**



TYPE	CODE	SIZE
	* APK700/02	cm 30xh38x16
	* APK700/03	cm 35xh38x16
	* CHK700/06	cm 69xh65
	* CHK700/08	cm 79xh75
	* CHK700/10	cm 84xh80
	* CHK700/12	cm 89xh85
	* CHK700/18	cm 93xh110

\* Disponibile in tutte le rifiniture dei fusti  
Available in all frame finishes

**CHK700/06AE**  
**COS003903**



TYPE CODE SIZE



- \* APK800/02 cm 45xh35x21
- \* APK800/03 cm 45xh35x28

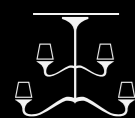

- \* CHK800/06 cm 65xh60
- \* CHK800/08 cm 110xh80
- \* CHK800/10 cm 115xh85
- \* CHK800/12 cm 115xh100

\* Disponibile in tutte le rifiniture dei fusti  
Available in all frame finishes

**CHK800/10AH**  
**COS003903**



CEILING LAMPS

TYPE

CODE

SIZE



AP1880/02	cm 42xh50x20
AP1880/03	cm 50xh52x26



CH1880/06	cm 65xh90
CH1880/08	cm 80xh100
CH1880/10	cm 85xh110
CH1880/12	cm 95xh120
CH1880/18	cm 110xh150



CL1880/04	cm 55xh50
-----------	-----------

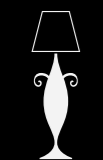

FL1880/06	cm 50xh180
-----------	------------



TL1880/06	cm 47xh79
-----------	-----------

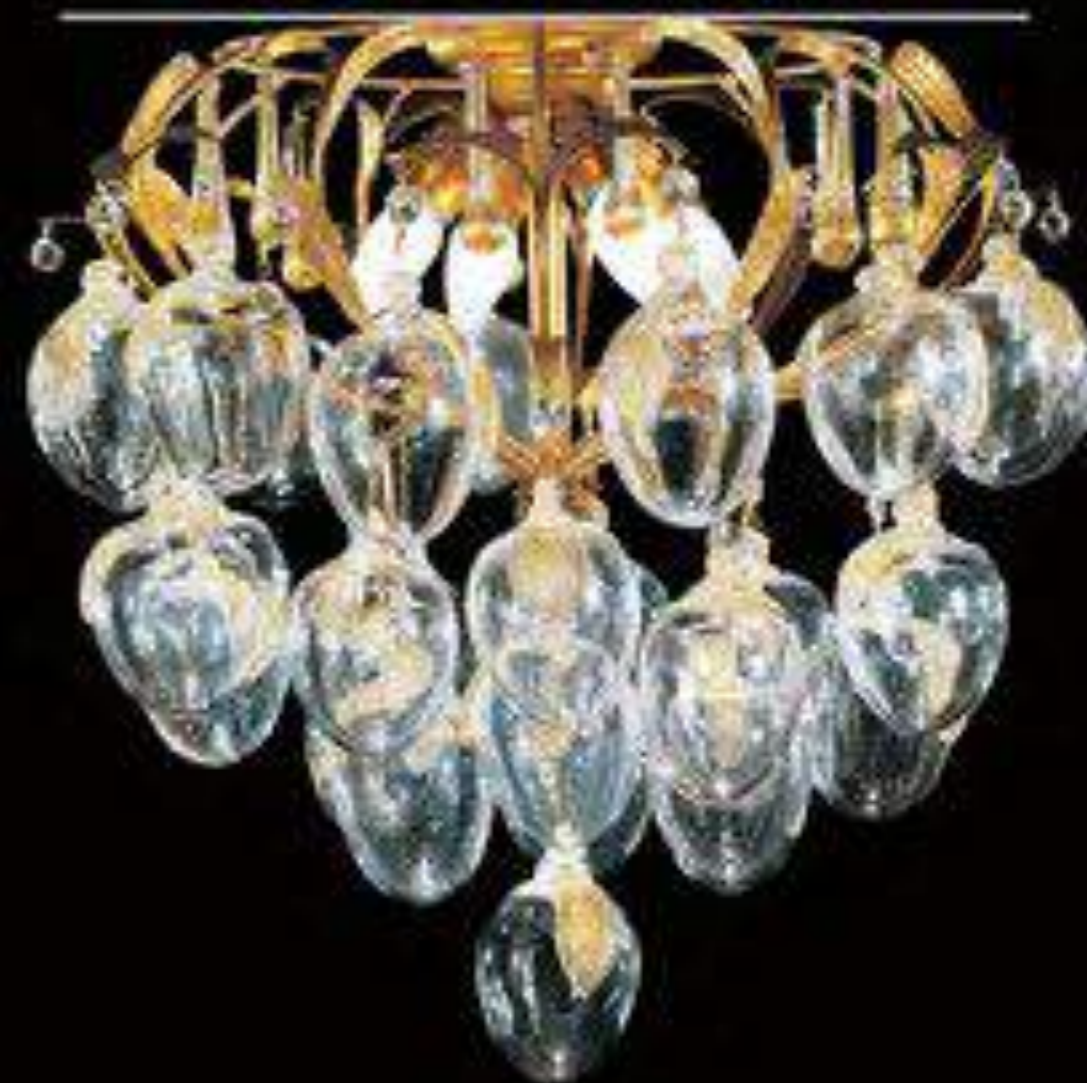

CL1880/04NG

**TYPE**      **CODE**      **SIZE**



AP1882/02      cm 42xh50x20  
 AP1882/03      cm 50xh52x26



CH1882/06      cm 65xh90  
 CH1882/08      cm 80xh100  
 CH1882/10      cm 85xh110  
 CH1882/12      cm 95xh120  
 CH1882/18      cm 110xh150

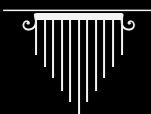

CL1882/04      cm 55xh50

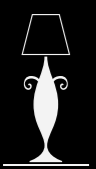

FL1882/06      cm 50xh180



TL1882/06      cm 48xh79



**CL1882/04NG30**

TYPE CODE SIZE



AP1883/02 cm 42xh50x20  
 AP1883/03 cm 50xh52x26



CH1883/06 cm 65xh90  
 CH1883/08 cm 80xh100  
 CH1883/10 cm 85xh110  
 CH1883/12 cm 95xh120  
 CH1883/18 cm 110xh150



CL1883/04 cm 55xh50

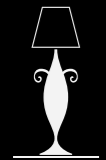

FL1883/06 cm 50xh180



TL1883/06 cm 47xh79

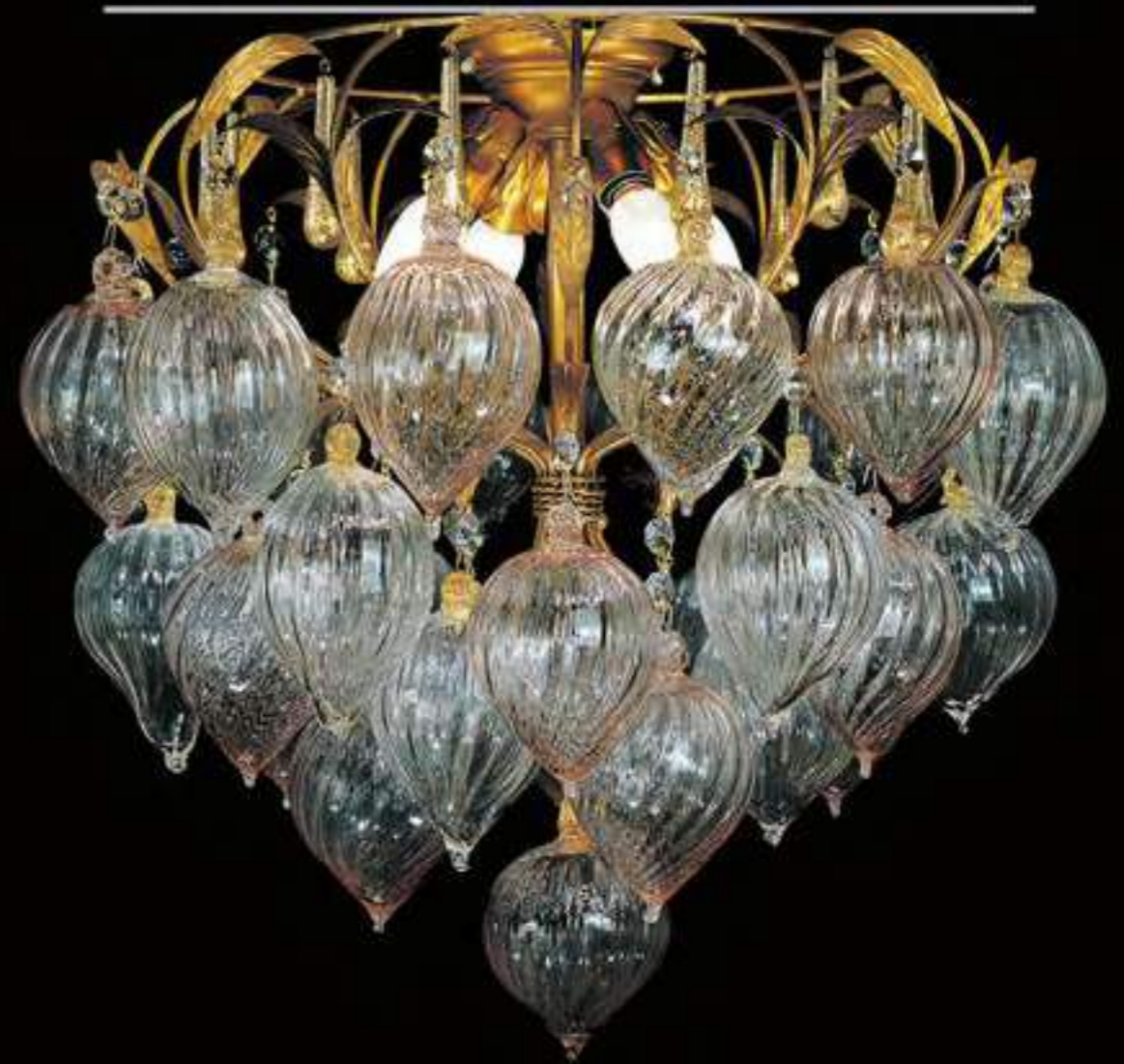
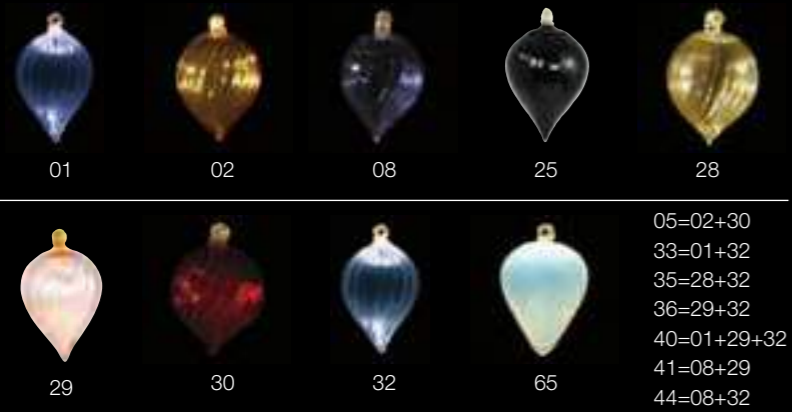

CL1883/04NG36



FLOOR LAMPS





**FL0850/01AG**  
CIP056753832

TYPE

CODE

SIZE





FL0850/01      cm 40xh132



TL0851/01      cm 35xh90  
TL0852/01      cm 25xh47

TYPE	CODE	SIZE
	AP1882/02	cm 42xh50x20
	AP1882/03	cm 50xh52x26

	CH1882/06	cm 65xh90
	CH1882/08	cm 80xh100
	CH1882/10	cm 85xh110
	CH1882/12	cm 95xh120
	CH1882/18	cm 110xh150

	CL1882/04	cm 55xh50
---	-----------	-----------

	* FL1882/06	cm 50xh180
---	-------------	------------

	* TL1882/06	cm 48xh79
---	-------------	-----------

\* Disponibile soltanto nelle rifiniture dei fusti dei lampadari  
Available in chandelier-frame finishes, only



**FL1882/06NE30**  
COS003908

TYPE	CODE	SIZE
	AP1920/02	cm 35xh48x19

	CH1920/05	cm 50xh70
	CH1920/08	cm 74xh88

	CL1920/04	cm 55xh50
--	-----------	-----------

	* FL1920/05	cm 50xh180
---	-------------	------------

	* TL1920/04	cm 45xh83
---	-------------	-----------

\* Disponibile soltanto nelle rifiniture dei fusti dei lampadari  
Available in chandelier-frame finishes, only



02 A0    08 A2    25 A5    29 A3    30 A1    30 A4



**FL1920/05NA08A2**  
COS003910



TYPE

CODE

SIZE



FL8399/05

cm 60xh172

**FL8399/05AG**  
COP068833104

TYPE

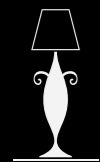

CODE

FL8401/01

SIZE

cm 45xh170



FL8401/01AA  
SPI002833104



TABLE LAMPS



TYPE



CODE

SIZE

TL0138/01	cm 45xh80
TL0266/01	cm 35xh33
TL0132/01	cm 28xh23
TL0129/01	cm 18xh18

**TL0138/01AD**  
SPI002836101



TYPE



CODE

SIZE

TL0193/04

cm 35xh55

TL0193/04AC  
FIS002760809





TYPE



CODE

SIZE

TL0374/03

cm 35xh55

TL0374/03AD  
FIS002811

TYPE



CODE

SIZE

TL0461/01AG cm 40xh75



TL0461/01AG  
COP040835



TYPE



CODE

TL0462/01

SIZE

cm 35xh86

**TL0462/01AD**  
QCF001835



TYPE



CODE

TL0501/01

SIZE

cm 40xh75

TL0501/01AD  
WAS009810



TYPE



CODE

SIZE

TL0560/05

cm 45xh84

TL0560/05AH  
COP053834

TYPE



CODE

TL0585/01

SIZE

cm 35xh72



TL0585/01AG  
COS030903



TYPE

CODE

SIZE



TL0595/03

cm 55xh70

TL0595/03AH  
COP071829



TYPE

CODE

SIZE



TL0596/02

cm 45xh64

TL0596/02AD  
OCS010852





TYPE

CODE

SIZE



TL0597/01

cm 46xh65

TL0597/01AG  
COP054827

TYPE



CODE

SIZE

TL0600/05

cm 50xh60



02



08



23



24



30



38



TL0600/05AG23  
COS003908



TL0662/01AC

TYPE

CODE

SIZE



AP0664/01 cm 20xh22x26



TL0662/01 cm 30xh47

TYPE



CODE

SIZE

TL0810/01 cm 42xh74

TL0811/01 cm 35xh58



**TL0810/01AD**  
COP049836101



TYPE

CODE

SIZE



TL0813/01

cm 45xh73



01



23

TL0813/01AH22  
COP049853836

TYPE

CODE

SIZE



TL0820/01

cm 45xh70



23

02



TL0820/01AA23  
ONP001832101



**TL0826/05AB**  
**COP044701843**

TYPE

CODE

SIZE



FL0826/05      cm 62xh170



TL0826/05      cm 43xh68  
TL0827/05      cm 34xh54



**TL0826/05AG**  
**COP044112**

TYPE	CODE	SIZE
------	------	------

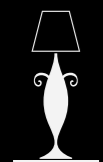

FL0826/05	cm 62xh170
-----------	------------



TL0826/05	cm 43xh68
TL0827/05	cm 34xh54



TYPE

CODE

SIZE



FL0826/05

cm 62xh170



TL0826/05

cm 43xh68

TL0827/05

cm 34xh54



02



23



29



38



TL0827/05AG29  
COP029825



TYPE



CODE

SIZE

TL0828/03

cm 43xh78

TL0828/03AC  
COS047829



TL0830/01AG27  
COP057834

TYPE

CODE

SIZE



TL0830/01

cm 45xh75



20

27

38

TYPE

CODE

SIZE



TL0831/01

cm 45xh75



22

23



TL0831/01AG23  
SPI002833104



**TL0841/01AD**  
VDS008850

**TL0840/01AD**  
VDS010850

TYPE

CODE

SIZE



TL0840/01      cm 30xh61

TL0841/01      cm 25xh50



TL0855/01AG01  
COP049838

TYPE

CODE

SIZE



TL0855/01 cm 42xh71



01

23

TYPE



CODE

TL0857/01

SIZE

cm 35xh63



TL0857/01AG  
COS030907



**TL0860/01AG**  
**STS002752903**

TYPE

CODE

SIZE



TL0860/01      cm 31xh136





**TL0881/01AA**  
**COS047705843**

**TYPE**



**CODE**

**SIZE**

FL0880/01      cm 45xh140



TL0881/01      cm 40xh64

TL0882/01      cm 25xh40

TYPE



CODE

TL0890/01

SIZE

cm 35xh65



TL0890/01AG  
COS030903

TYPE



CODE

TL0891/01

SIZE

cm 30xh64



TL0891/01AB  
QCS001906



TYPE



CODE

SIZE

TL0892/01

cm 40xh52

TL0892/01AG  
RCS001903

TYPE



CODE

TL0893/01

SIZE

cm 40xh59



TL0893/01AB  
RDS002909

TYPE



CODE

TL0894/01

SIZE

cm 35xh66



TL0894/01AG  
COS030914



TYPE

CODE

SIZE



\* TL0900/04 cm 44xh57

\* Disponibile soltanto nelle rifiniture dei fusti dei lampadari  
Available in chandelier-frame finishes, only

TL0900/04NA  
CIP061838



TYPE



CODE

SIZE

TL0905/02 cm 40xh68

TL0906/01 cm 23xh43

TL0905/02AG  
COP038851





TYPE



CODE

SIZE

TL0955/01 cm 25xh60

TL0956/01 cm 22xh46

**TL0955/01AG**  
COS017752907



TYPE



CODE

SIZE

TL0970/01

cm 35xh67

TL0970/01AB  
COS030903

TYPE



CODE

TL0971/01

SIZE

cm 31xh69



TL0971/01AG  
COP024751820



TYPE



CODE

TL0972/01

SIZE

cm 41xh64

TL0972/01AB  
PAS003761820618



**TL0973/01AB**  
SPI001752838101

TYPE



CODE

TL0973/01

SIZE

cm 33xh60



TYPE



CODE

TL0975/01

SIZE

cm 43xh71

**TL0975/01AG**  
CIP042838



TYPE



CODE

TL0980/01

SIZE

cm 56xh98

**TL0980/01AG**  
SPI003701752843

TYPE

CODE

SIZE



AP1800/02	cm 42xh50x20
AP1800/03	cm 50xh52x26



CH1800/06	cm 60xh80
CH1800/08	cm 80xh85
CH1800/10	cm 85xh95
CH1800/12	cm 95xh120
CH1800/18	cm 110xh140
CH1800/M3	cm 32xh56
CH1800/M6	cm 47xh55



CL1800/04	cm 55xh50
-----------	-----------



* FL1800/06	cm 50xh180
-------------	------------



* TL1800/06	cm 47xh79
-------------	-----------

\* Disponibile soltanto nelle rifiniture dei fusti dei lampadari  
Available in chandelier-frame finishes, only



TL1800/06NG  
COS003907



TYPE

CODE

SIZE



AP1830/02	cm 42xh50x20
AP1830/03	cm 50xh52x26



CH1830/06	cm 60xh80
CH1830/08	cm 78xh85
CH1830/10	cm 85xh95
CH1830/12	cm 95xh120
CH1830/18	cm 110xh140
CH1830/M3	cm 32xh56
CH1830/M6	cm 47xh55



CL1830/04	cm 55xh50
-----------	-----------



* FL1830/06	cm 50xh180
-------------	------------



* TL1830/06	cm 47xh79
-------------	-----------

\* Disponibile soltanto nelle rifiniture dei fusti dei lampadari  
Available in chandelier-frame finishes, only



TL1830/06NE  
COS003907

TYPE

CODE

SIZE



AP1850/02	cm 42xh50x20
AP1850/03	cm 50xh52x26



CH1850/06	cm 60xh75
CH1850/08	cm 80xh85
CH1850/10	cm 85xh90
CH1850/12	cm 95xh120
CH1850/18	cm 110xh130
CH1850/M3	cm 32xh56
CH1850/M6	cm 47xh55



CL1850/04	cm 55xh50
-----------	-----------

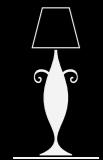

* FL1850/06	cm 50xh180
-------------	------------



* TL1850/06	cm 47xh79
-------------	-----------

\* Disponibile soltanto nelle rifiniture dei fusti dei lampadari  
Available in chandelier-frame finishes, only



TL1850/06NF25  
COS003903

TYPE

CODE

SIZE



AP1880/02	cm 42xh50x20
AP1880/03	cm 50xh52x26



CH1880/06	cm 65xh90
CH1880/08	cm 80xh100
CH1880/10	cm 85xh110
CH1880/12	cm 95xh120
CH1880/18	cm 110xh150



CL1880/04	cm 55xh50
-----------	-----------



* FL1880/06	cm 50xh180
-------------	------------





* TL1880/06	cm 47xh79
-------------	-----------

\* Disponibile soltanto nelle rifiniture dei fusti dei lampadari  
Available in chandelier-frame finishes, only



TL1880/06NG  
COS003902

TYPE	CODE	SIZE
	AP1882/02	cm 42xh50x20
	AP1882/03	cm 50xh52x26

	CH1882/06	cm 65xh90
	CH1882/08	cm 80xh100
	CH1882/10	cm 85xh110
	CH1882/12	cm 95xh120
	CH1882/18	cm 110xh150

	CL1882/04	cm 55xh50
---	-----------	-----------

	* FL1882/06	cm 50xh180
---	-------------	------------

	* TL1882/06	cm 47xh79
---	-------------	-----------

\* Disponibile soltanto nelle rifiniture dei fusti dei lampadari  
Available in chandelier-frame finishes, only



TL1882/06NG30  
COS003908

TYPE CODE SIZE



AP1883/02 cm 42xh50x20  
AP1883/03 cm 50xh52x26



CH1883/06 cm 65xh90  
CH1883/08 cm 80xh100  
CH1883/10 cm 85xh110  
CH1883/12 cm 95xh120  
CH1883/18 cm 110xh150



CL1883/04 cm 55xh50

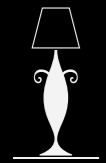

\* FL1883/06 cm 50xh180



\* TL1883/06 cm 47xh79

\* Disponibile soltanto nelle rifiniture dei fusti dei lampadari  
Available in chandelier-frame finishes, only

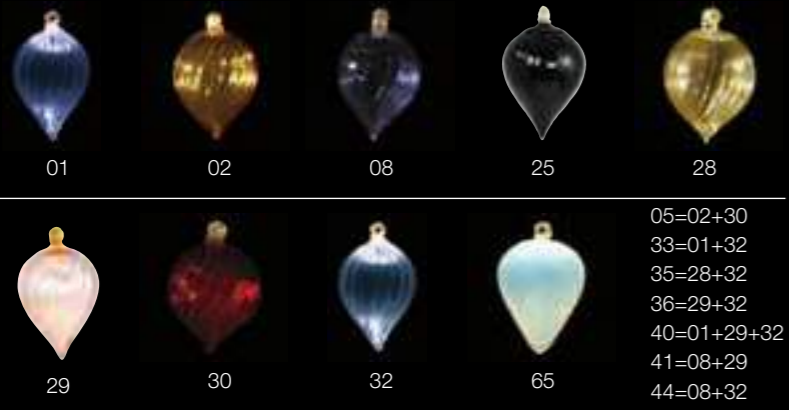

TL1883/06NA36  
COS003848

TYPE

CODE

SIZE



AP1884/02	cm 42xh50x20
AP1884/03	cm 50xh52x26



CH1884/06	cm 65xh90
CH1884/08	cm 80xh100
CH1884/10	cm 85xh110
CH1884/12	cm 95xh120
CH1884/18	cm 110xh150



CL1884/04	cm 55xh50
-----------	-----------

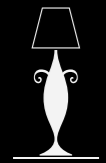

* FL1884/06	cm 50xh180
-------------	------------



* TL1884/06	cm 47xh79
-------------	-----------

\* Disponibile soltanto nelle rifiniture dei fusti dei lampadari  
Available in chandelier-frame finishes, only



TL1884/06NA40  
COS003910

TYPE

CODE

SIZE



AP1920/02 cm 35xh48x19



CH1920/05 cm 50xh70  
CH1920/08 cm 74xh88



CL1920/04 cm 55xh50



\* FL1920/05 cm 50xh180



\* TL1920/04 cm 45xh83

\* Disponibile soltanto nelle rifiniture dei fusti dei lampadari  
Available in chandelier-frame finishes, only



TL1920/04NA08A2  
COS002909

TYPE	CODE	SIZE
	AP1920/02	cm 35x48x19

	CH1920/05	cm 50x70
	CH1920/08	cm 74x88

	CL1920/04	cm 55x50
---	-----------	----------

	* FL1920/05	cm 50x180
---	-------------	-----------

	* TL1920/04	cm 45x83
---	-------------	----------

\* Disponibile soltanto nelle rifiniture dei fusti dei lampadari  
Available in chandelier-frame finishes, only



TL1920/04NC29A3  
COP002823



TYPE

CODE

SIZE



AP1930/02 cm 35xh48x19



CH1930/04 cm 52xh60



CL1930/04 cm 55xh50



\* FL1930/04 cm 50xh180



\* TL1930/04 cm 45xh57

\* Disponibile soltanto nelle rifiniture dei fusti dei lampadari  
Available in chandelier-frame finishes, only



TL1930/04NI  
COS002707843

TYPE

CODE

SIZE



TLA001/01

cm 49xh84



TLA001/01AD  
COI056832101

TYPE



CODE

TLA002/01

SIZE

cm 45xh88



TLA002/01  
COP056825104

TYPE



CODE

TLA009/01

SIZE

cm 45xh90



TLA009/01  
COS049911



**TLA011/01**

**TYPE**



**CODE**

TLA0011/01

**SIZE**

cm 24xh32

TYPE

CODE

SIZE



TLA930/01	cm 35xh70
TLA931/01	cm 23xh47



02



17



18



TLA930/01AG18  
COS030850

TYPE



CODE

SIZE

TLA932/05

cm 39xh65



02



17



18



TLA932/03AG17  
COP033751832101



TLA933/01AG02  
COP032751832101

TYPE

CODE

SIZE



TLA933/01	cm 36xh68
TLA931/01	cm 23xh47



02

17

18





TYPE

CODE

SIZE



TLM022/01	cm 46xh69
TLM023/01	cm 28xh56

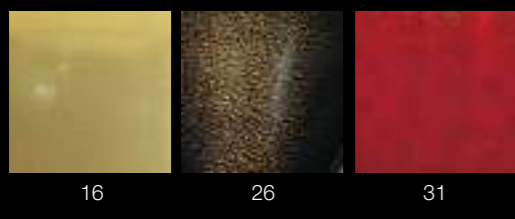

16

26

31

TLM022/01AG16  
OAS006754849



TLM022/01AG26  
GOP003752833

TYPE

CODE

SIZE



TLM022/01	cm 46xh66
TLM023/01	cm 28xh56



16

26

31



TYPE

CODE

SIZE



TLM022/01	cm 46xh66
TLM023/01	cm 28xh56

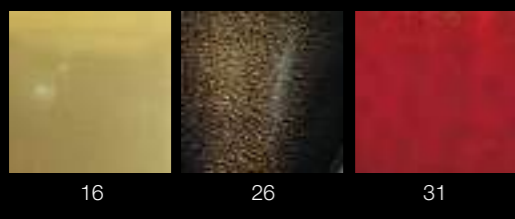

TLM022/01AG31  
GOP003762836



TYPE

CODE

SIZE



TLM025/01

cm 40xh85

TLM025/01AG  
WAS009762616



TYPE

CODE

SIZE



TLM029/01

cm 42xh85

TLM029/01AG  
COP049762834

TYPE

CODE

SIZE



TLM033/01 cm 35xh82  
TLM031/01 cm 25xh76



TLM031/01AG  
OAS001762850

TLM033/01AG  
OBS006762850



TYPE

CODE

SIZE



TLM045/01  
TLM046/01

cm 50xh75  
cm 30xh55

TLM045/01AG  
PAP004917

TYPE

CODE

SIZE



TLM080/01	cm 42xh74
TLM081/01	cm 25xh56



26

31



TLM080/01AG26  
COP049752834



TYPE

CODE

SIZE



TLM085/01	cm 30xh66
TLM086/01	cm 24xh47



02



25



29



30



TLM086/01AG29  
COP014752823



TLM090/01AG02  
PAS005762203

TYPE

CODE

SIZE



TLM090/01	cm 58xh78
TLM091/01	cm 35xh62

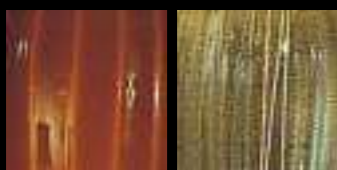

02

28



TYPE

CODE

SIZE



TLM090/01	cm 40xh78
TLM091/01	cm 35xh62

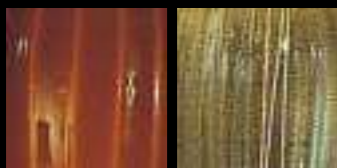

02

28

TLM090/01AG28  
OCP011762835

TYPE

CODE

SIZE

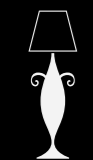

FLM097/01 cm 45xh160



TLM099/01 cm 41xh73  
TLM095/01 cm 35xh66  
TLM096/01 cm 25xh48



TLM095/01AG25  
COS030903

TYPE

CODE

SIZE



FLM097/01 cm 45xh160



TLM099/01	cm 41xh73
TLM095/01	cm 35xh66
TLM096/01	cm 25xh48



TLM099/01AB12  
COS038201

TYPE

CODE

SIZE



TLM100/01	cm 50xh77
TLM101/01	cm 28xh62

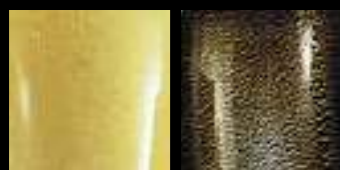

16

26



TLM101/01AG16  
VDS009762849

TLM100/01AG16  
PAS004762917



TLM100/01AG26  
PAS004762307

TYPE

CODE

SIZE



TLM100/01	cm 50xh77
TLM101/01	cm 28xh62

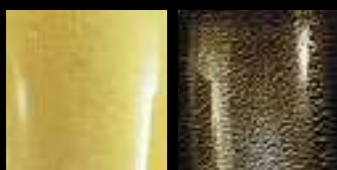

16

26

TYPE

CODE

SIZE



TLM103/01

cm 50xh77



16

26



TLM103/01AG26  
PAS004704843





TYPE

CODE

SIZE



TLM103/01

cm 50xh77



16

26

TLM103/01AG31  
PAS004762401

TYPE

CODE

SIZE



TLM104/01

cm 35xh78



16

26



TLM104/01AG31  
OAS006762908



TYPE



CODE

SIZE

TLM200/01	cm 48xh81
TLM201/01	cm 30xh63

**TLM200/01AG**  
SPI002752837101



TYPE



CODE

SIZE

TLM210/01	cm 36xh62
TLM211/01	cm 25xh52

TLM210/01AG  
COP032751762835



TLM212/01AG16  
PAS005605

TYPE

CODE

SIZE



TLM212/01

cm 57xh80

TLM213/01

cm 25xh50



16

26



TYPE

CODE

SIZE



TLM212/01

cm 57xh77

TLM213/01

cm 25xh50

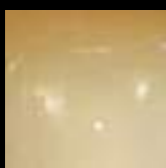

16

26

TLM212/01AG26  
PAS005606



TYPE

CODE

SIZE



TLM222/01

cm 57xh83

TLM222/01AG  
PAS005204



TYPE

CODE

SIZE



TLM223/01	cm 58xh84
TLM224/01	cm 43xh60

TLM223/01AG  
PAS005711764602





TYPE

CODE

SIZE



* TLM230/01	cm 47xh72
* TLM231/01	cm 33xh51

\* Disponibile soltanto nelle rifiniture dei fusti dei lampadari  
Available in chandelier-frame finishes, only



02

02

25

25



D3



D4



D3

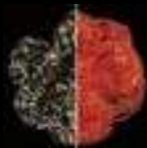

D5

TLM230/01NG02D4  
GOP003754837501



TLM230/01NG25D5  
PAS005711602

TYPE	CODE	SIZE
	* TLM230/01	cm 57xh72
	* TLM231/01	cm 33xh51

\* Disponibile soltanto nelle rifiniture dei fusti dei lampadari  
Available in chandelier-frame finishes, only

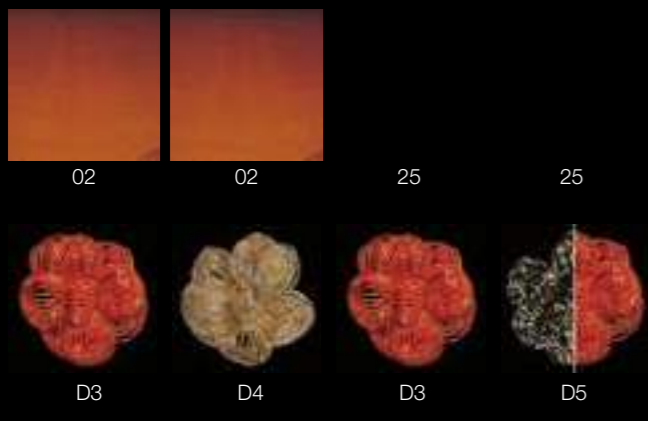



TYPE

CODE

SIZE



TLM235/01

cm 51xh91

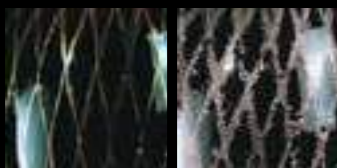

26

42

TLM235/01AB42  
COP070701843

TYPE

CODE

SIZE



TLM235/01

cm 66xh100

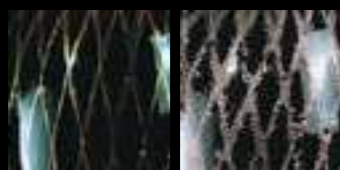

26

42



TLM235/01AG26  
PAS006620

TYPE



CODE

TLM300/01

SIZE

cm 26xh53



TLM300/01AB  
CIS015816

TYPE



CODE

TLM301/01

SIZE

cm 24xh44



TLM301/01AB  
CIS015816



TYPE



CODE

SIZE

TLV013/01

cm 30xh56

TLV013/01AD  
GOP001754836501



TYPE



CODE

SIZE

TLV617/01 cm 42xh68

TLV616/01 cm 35xh56

TLV615/01 cm 25xh44

TLV617/01AD  
COP040750832





ACCESSORIES

MANIGLIE PER PORTE E FINESTRE  
MANIGLIE PER CASSETTI  
PENDAGLI PER TENDE



AC0101



AC0102



AC0103



AC0104



AC0105



AC0106



AC0107



AC0108



AC0109



AC0110



AC0111



AC0112



AC0113



AC0114



AC0115



AC0116



AC0117

DOOR AND WINDOW  
HANDLES KNOBS  
PENDANTS FOR CURTAINS



## PERSONALIZZAZIONI

Vi siete innamorati di un design particolare nella nostra collezione...

Ma sfortunatamente avete bisogno di una misura non disponibile oppure non riportata nel catalogo?

Siete un Interior Designer che sta lavorando ad un prestigioso progetto ma dovete abbinare le rifiniture e non trovate un colore che si addice perfettamente alle Vostre esigenze?

Avete visto un articolo che Vi emoziona, ma ne vorreste sostituire i vetri con quelli visti su un altro articolo?

Siete un Architetto impegnato nello sviluppo del lay-out di un noto albergo ed avete bisogno di una consulenza?

O magari vorreste attuare una stretta collaborazione per la creazione di prodotti ad-hoc?

Siete un professionista qualificato e cercate una soluzione per un problema simile o anche molto diverso?

Non Vi rassegnate!

Comunicateci il Vostro problema, spiegateci le Vostre necessità.

Consultate il nostro Web-Site e cercate ulteriori informazioni. Se non trovate la risposta alle Vostre domande, contattateci con fiducia tramite e-mail, fax o telefono.

Vi chiediamo solo un minimo di tempo per analizzare le Vostre esigenze e... spesso, anzi molto spesso, siamo in grado di risolvere il Vostro problema! Magari pure senza grandi spese aggiuntive...

## TAYLOR-MADE SERVICES

Different finishes? Changing sizes?

You have fallen in love with a particular design of our collection...

But, unfortunately, you need a size which seems to be unavailable in the catalogue?

You are a known Interior Designer who is working on an important project and you have to perfectly match the finishes but, unfortunately, you cannot find a suitable one in our range?

You have seen an article which really excites you but you would like to substitute the glass pendants with those seen on another article?

Or, maybe, you are working as an Architect developing the lay-out of a prestigious hotel and need to discuss a few ideas with us? Or, you would like to propose a co-operation, the creation of tailor-made objects?

You are a qualified professional who looks for a solution of a similar problem or, perhaps, one completely different? Do not give up! Tell us your requirements, your needs, your problems.

Visit our web-site which contains valuable product information and company details. Should you not find an answer to your question or a solution to your problem, do not hesitate to contact us by e-mail, fax or phone.

All we ask for is a minimum of time to analyze the matter and... often, in most cases, we are able to resolve the problem! Perhaps even with no, or just minimal, additional costs...

# INDICE | INDEX



AP0664/01AC  
page 19



AP1050/03NAG0  
page 21



AP1050/03NCI7  
page 23



AP1050/07NAI9  
page 25



AP1050/07NCD3  
page 27



AP1050/07NCI6  
page 29



FL0850/01AG  
page 97



FL1882/06NE30  
page 99



FL1920/05NA08A2  
page 101



FL8399/05AG  
page 103



FL8401/01AA  
page 105



TL0138/01AD  
page 109



AP1850/02NG30  
page 31



AP1920/02NG30A1  
page 33



CH1000/1232  
page 37



CH1050/05NID3  
page 39



CH1800/M6NG  
page 41



CH1820/06NG30  
page 43



TL0193/04AC  
page 111



TL0374/03AD  
page 113



TL0461/01AG  
page 115



TL0462/01AD  
page 117



TL0501/01AD  
page 119



TL0560/05AH  
page 121



CH1830/06NE  
page 45



CH1831/M3NC10  
page 47



CH1840/10NC  
page 49



CH1850/08NF25  
page 51



CH1850/10NA01  
page 53



CH1850/18NG30  
page 55



TL0585/01AG  
page 123



TL0595/03AH  
page 125



TL0596/02AD  
page 127



TL0597/01AG  
page 129



TL0600/05AG23  
page 131



TL0662/01AC  
page 133



CH1860/06NE08  
page 57



CH1880/08NL  
page 59



CH1882/08NC30  
page 61



CH1883/08NJ36  
page 63



CH1885/10NC  
page 65



CH1900/08NG  
page 67



TL0810/01AH  
page 135



TL0813/01AH22  
page 137



TL0820/01AA23  
page 139



TL0826/05AB  
page 141



TL0826/05AG  
page 143



TL0827/05AG29  
page 145



CH1920/05NC29A3  
page 69



CH1920/08NA08A2  
page 71



CH1930/04NI  
page 73



CH2000/12NG30  
page 75



CH2222/08NJ36  
page 77



CH3100/18NF25  
page 79



TL0828/03AC  
page 147



TL0830/01AD27  
page 149



TL0831/01AG23  
page 151



TL0840/01AD  
page 153



TL0841/01AD  
page 153



TL0855/01AG01  
page 155



CH3300/20NA33  
page 81



CHK700/06AE  
page 83



CHK800/10AH  
page 85



CL1880/04NG  
page 89



CL1882/04NG30  
page 91



CL1883/04NG36  
page 93



TL0857/01AG  
page 157



TL0860/01AG  
page 159



TL0881/01AA  
page 161



TL0890/01AG  
page 163



TL0891/01AB  
page 165



TL0892/01AG  
page 167



TL0893/01AB  
page 169



TL0894/01AG  
page 171



TL0900/04NA  
page 173



TL0905/02AG  
page 175



TL0955/01AG  
page 177



TL0970/01AB  
page 179



TLM080/01AG26  
page 239



TLM086/01AG29  
page 241



TLM090/01AG02  
page 243



TLM090/01AG28  
page 245



TLM095/01AG25  
page 247



TLM099/01AB12  
page 249



TL0971/01AG  
page 181



TL0972/01AB  
page 183



TL0973/01AB  
page 185



TL0975/01AG  
page 187



TL0980/01AG  
page 189



TL1800/06NG  
page 191



TLM100/01AG16  
page 251



TLM100/01AG26  
page 253



TLM101/01AG16  
page 251



TLM103/01AG26  
page 255



TLM103/01AG31  
page 257



TLM104/01AG31  
page 259



TL1830/06NE  
page 193



TL1850/06NF25  
page 195



TL1880/06NG  
page 197



TL1882/06NG30  
page 199



TL1883/06NA36  
page 201



TL1884/06NA40  
page 203



TLM200/01AG  
page 261



TLM210/01AG  
page 263



TLM212/01AG16  
page 265



TLM212/01AG26  
page 267



TLM222/01AG  
page 269



TLM223/01AG  
page 271



TL1920/04NA08A2  
page 205



TL1920/04NC29A3  
page 207



TL1930/04NI  
page 209



TLA001/01AD  
page 211



TLA002/01  
page 213



TLA009/01  
page 215



TLM230/01NG02D4  
page 273



TLM230/01NG25D5  
page 275



TLM235/01AB42  
page 277



TLM235/01AG26  
page 279



TLM300/01AB  
page 281



TLM301/01AB  
page 283



TLA011/01  
page 217



TLA930/01AG18  
page 219



TLA932/03AG17  
page 221



TLA933/01AG02  
page 223



TLM022/01AG16  
page 225



TLM022/01AG26  
page 227



TLV013/01AD  
page 285



TLV617/01AD  
page 287



TLM022/01AG31  
page 229



TLM025/01AG  
page 231



TLM029/01AG  
page 233



TLM031/01AG  
page 235



TLM033/01AG  
page 235



TLM045/01AG  
page 237

# LEGGERE I CODICI

Le misure riportate nel catalogo sono metriche. Per convertirle in Inch esse devono essere divise per 2,54. Tutte le misure sono riportate come segue: Larghezza/Altezza/Profondità oppure Ø(Diametro)/Altezza. Esse fanno riferimento alle dimensioni massime, sono approssimative e hanno carattere puramente indicativo.

I colori degli articoli completi, dei loro componenti quali vetri, cristalli, marmi, alabastrini ecc. e quelli relativi alle rifiniture sono soggetti a variazioni in relazione all'appartenenza a determinati gruppi di prodotti, secondo i materiali usati, in relazione alla loro posizione, al loro taglio, alla loro misura, alla loro forma, alla naturale variazione delle materie prime e alla manifattura artigianale.

I colori della stampa nel presente catalogo seppur di altissima qualità non possono che avvicinarsi al colore reale degli oggetti fotografati.

Pataviumart si riserva di apportare in qualsiasi momento modifiche tecniche ed estetiche ai prodotti atte al miglioramento degli stessi.

Tutti gli articoli presenti nel catalogo vengono identificati da un Codice Articolo composto da vari elementi. Ogni elemento del codice dà informazioni riguardanti i diversi aspetti dell'articolo stesso, dei suoi dettagli o della presenza di particolari componenti. La lunghezza del codice varia pertanto da articolo ad articolo.

È importante riportare il Codice Articolo in maniera esatta sugli ordini e controllarne la correttezza sulle successive Fatture Proforma, Conferme d'Ordine e sulle Fatture definitive. Per la Pataviumart è il Codice Articolo ad essere decisivo su un qualsiasi ordine pervenuto; eventuali descrizioni o misure aggiuntive hanno carattere puramente illustrativo e la loro concordanza con il Codice Articolo non può essere controllata dalla Pataviumart.

Pertanto, eventuali errori causati dalla incongruenza tra Codice Articolo e descrizione aggiuntiva su un ordine non saranno ritenuti dalla Pataviumart motivo di contestazione. Per questo motivo La invitiamo a specificare solamente il Codice Articolo ed aggiungere ulteriori descrizioni esclusivamente nel caso in cui esse siano strettamente indispensabili.

Nel caso in cui si trattasse di personalizzazioni, cioè di modifiche/ricieste non-standard (vedi il rispettivo capitolo), queste devono essere segnalate ed evidenziate in maniera tale da non dare adito a fraintendimenti.

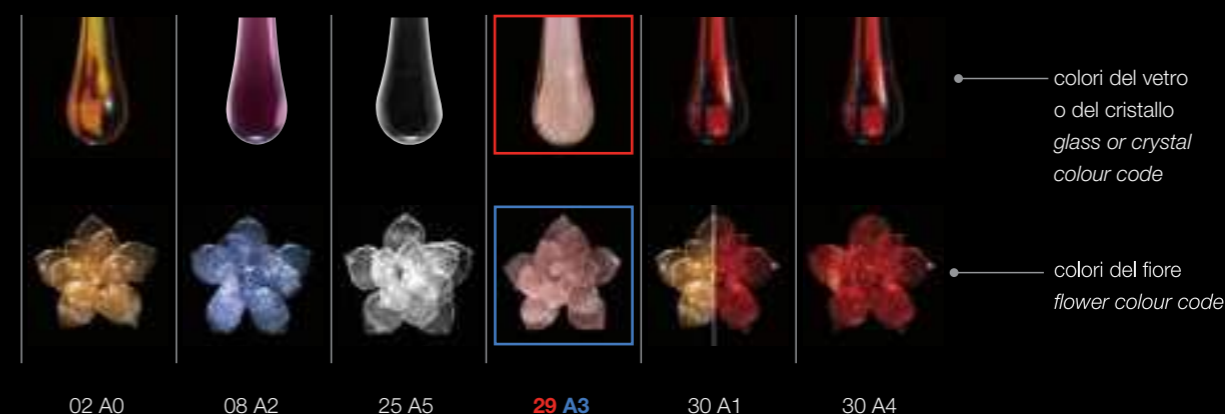
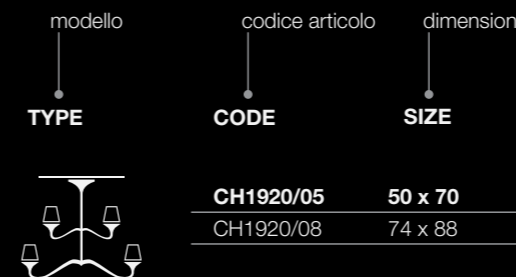

# READ THE CODE

Metric measurement is used in this catalogue. To obtain the dimensions in inch, please divide by 2,54. The sizes are listed as follows: Width/Height/Depth or Ø(Diameter)/Height. All reported sizes refer to the maximal dimensions; they are approximate and merely informative. The colours of the shown articles and its components such as Murano glasses, crystals, marbles, alabasters etc. as well as the finishes are subject to variation according to the product group, the used raw materials, to position, cut, size, shape and to the artisanal way of manufacturing.

The printing of the colours of the catalogue has been made according to the highest, today available quality standards but still cannot it match the original colours of the objects.

Content is subject to change. Pataviumart reserves the right to make any technical and aesthetical changes suitable to improve the products at any time. Errors and misprint excepted.

All articles shown in the catalogue can be identified by an Article Code composed of various elements. Each element of the code contains information of certain aspects of the article, its details or the presence or lack of certain components. Thus, the length of the code varies from article to article.

It is very important to copy the Article Code correctly to possible orders and to cross-check its correspondence on subsequently received Proforma Invoices, Order Confirmations or final Invoices.

We would like to remind you that the decisive part on any received order is the Article Code; possible additional information or dimensions will be regarded as purely 'descriptive' as it is impossible for Pataviumart to check their correspondence with the reported article codes. Contingent errors caused by the incongruence between Article Code and additional descriptions or dimensions on a possible order cannot be the object of claims and will not be accepted as such.

For this reason we kindly invite you not to add additional information or descriptions unless they are absolutely necessary for a correct identification of the ordered article.

In case you requested tailor-made services, i.e. modifications non-standard (see the respective chapter), these must be clearly and unconfutably marked.



**CH1920/05NC29A3** ● codice articolo - article code  
**COS003848** ● codice paralume - shade code

## Composizione del codice



# COLORI E RIFINITURE FINISHES & CODES

## Colore Fusto Lampade | Lamp Frame Finishes



## Colore Fusto Lampari | Chandelier Frame Finishes

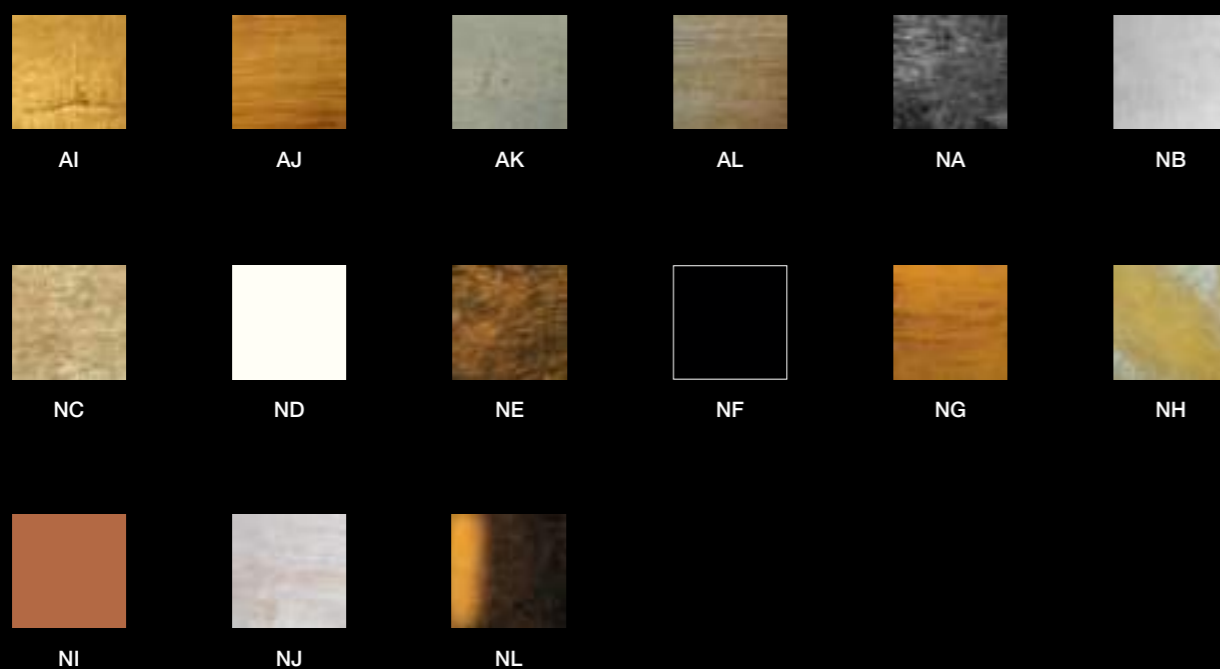

## LEGENDE | TABLES

### Codice TIPO ARTICOLO

<b>Code</b>	<b>ARTICLE TYPE</b>
AC	Accessorio / Accessory
AP	Applique / Applique
CH	Lampadario / Chandelier
CL	Plafoniera / Ceiling Lamp
FL	Piantana / Table Lamp
TL	Lampada da Tavolo / Floor Lamp

### Codice COLORI VERNICIATURE LAMPADE

<b>Code</b>	<b>LAMP FRAME FINISHES</b>
AA	Argento Lucido / Silver Glossy
AB	Argento Antico / Silver Antique
AC	Brunito / Burnished
AD	Lucido / Glossy
AE	Nero / Black
AF	Nichel / Nickel
AG	Oro Francese / French Gold
AH	Oro Zecchino / Gold
AI	Foglia Oro / Gold Foil
AJ	Foglia Oro Antico / Gold Foil Antique
AK	Foglia Argento / Silver Foil
AL	Foglia Argento Antico / Silver Foil Antique
AM	Fgl Oro & Blu / Gold Foil & Blue
AN	Fgl Oro & Rosso / Gold Foil & Red
AP	Fgl Arg & Blu / Silver Foil & Blue
AQ	Fgl Arg & Rosso / Silver Foil & Red
AR	Fgl Oro Ricco / Gold Foil "Ricco"
AS	Fgl Oro & Arg / Gold & Silver Foil
AT	Arg Ant. & Fgl Oro & Fgl Arg / Gold & Silver Foil & Silver Antique
AU	Fgl Arg & Simil Marmo / Silver Foil & Marbled
AV	Fgl Rame / Copper Foil
AZ	Avorio Perla & Fgl Arg / Silver Foil & Pearl Ivory
MA	M. Perla & Fgl Arg / Silver Foil & Mother-of-Pearl
MB	Viola & Fgl Arg / Silver Foil & Violet
MC	Viola & Fgl Oro / Gold Foil & Violet
MD	Arg Antico & Fgl Rame / Copper Foil and Silver Antique
ME	Avorio & Oro & Fgl Oro / Gold Foil & Ivory & Gold
MF	Nero & Fgl Oro / Gold Foil & black
MG	Avorio & Oro & Fgl Rame / Copper Foil & Ivory & Gold
MH	Fgl Arg & Verde / Silver Foil & Green
MI	Nero & Fgl Rame / Copper Foil & Black
MO	M. Perla & Oro Chiaro / Mother-of-Pearl & Light Gold
MP	Madre Perla / Mother-of-Pearl

### Codice COLORI VERNICIATURE LAMPADARI

<b>Code</b>	<b>CHANDELIER FRAME FINISHES</b>
AI	Foglia Oro / Gold Foil
AJ	Foglia Oro Antico / Gold Foil Antique
AK	Foglia Argento / Silver Foil
AL	Foglia Argento Antico / Silver Foil Antique
AM	Fgl Oro & Blu / Blue & Gold Foil
AN	Fgl Oro & Rosso / Red & Gold Foil
AP	Fgl Arg & Blu / Blue & Silver Foil
AQ	Fgl Arg & Rosso / Red & Silver Foil
AR	Fgl Oro Ricco / Gold Foil "Ricco"
AS	Fgl Oro & Arg / Gold & Silver Foil
AT	Arg Ant. & Fgl Oro & Fgl Arg / Gold & Silver Foil & Silver Antique
AU	Fgl Arg & Simil Marmo / Silver Foil & Marbled
AV	Fgl Rame / Copper Foil
AZ	Avorio Perla & Fgl Arg / Silver Foil & Pearl Ivory
MA	M. Perla & Fgl Arg / Silver Foil & Mother-of-Pearl
MB	Viola & Fgl Arg / Silver Foil & Violet
MC	Viola & Fgl Oro / Gold Foil & Violet
MD	Arg Antico & Fgl Rame / Copper Foil and Silver Antique
ME	Avorio & Oro & Fgl Oro / Gold Foil & Ivory & Gold
MF	Nero & Fgl Oro / Gold Foil & black
MG	Avorio & Oro & Fgl Rame / Copper Foil & Ivory & Gold
MH	Fgl Arg & Verde / Silver Foil & Green
MI	Nero & Fgl Rame / Copper Foil & Black
MO	M. Perla & Oro Chiaro / Mother-of-Pearl & Light Gold
MP	Madre Perla / Mother-of-Pearl
NA	Arg Antico / Silver Antique
NB	Argento / Silver
NC	Avorio & Oro / Ivory & Gold
ND	Bianco / White
NE	Brunito & Oro / Burnished & Gold
NF	Nero / Black
NG	Oro Antico / Gold Antique
NH	Oro & Argento / Gold & Silver
NI	Oro Rosa / Rose Gold
NJ	Platino / Platinum
NK	Rosso & Oro / Red & Gold
NL	Ruggine & Oro / Rust & Gold
NM	Verde & Oro / Green & Gold
NN	Ceramica Bianca / White Ceramic
NO	Oro Lucido / Glossy Gold

NP	Bianco Lucido / Glossy White
NQ	Blu Lapis / Blue Lapis
NR	Rosso / Red
NS	Avorio Perla / Pearl Ivory
NT	Verde & Blu / Green & Blue
NU	Ruggine & Colori / Rust & Colours
NV	Viola / Violet
NZ	Oro Ricco / Gold "Ricco"
OC	Oro Chiaro / Light Gold
RA	Avorio / Ivory
RB	Avorio & Blu Ossido / Blue Oxyde & Ivory
RC	Rosa Chiaro / Light Rose
RD	Blu Ossido / Blue Oxyde
RE	Rosso Ossido / Red Oxyde
RF	Viola Metallizzato / Metallic Violet
RG	Marrone Metallizzato / Metallic Brown
RH	Sabbia Lucido / Shiny Sand
RS	Rosa Scuro / Dark Rose

### Codice COLORI VETRO & CRISTALLO dominante

<b>Code</b>	<b>MURANO GLASS &amp; CRYSTAL COLOURS</b>
01	Alessandrite / Alessandrite
02	Ambra / Amber
03	Ambra & Oro / Amber & Gold
04	Ambra & Nero / Amber & Black
05	Ambra & Rosso / Amber & Red
06	Ambra Chiaro / Light Amber
07	Ambra Chiaro & Scuro / Light & Dark Amber
08	Ametista / Amethyst
09	Ametista & Bluino / Amethyst & Light Blue/Bluino
10	Ambra Scuro / Dark Amber
11	Arancione / Orange
12	Argento / Silver
13	Argento & Oro / Silver & Gold
14	Avorio / Ivory
15	Avorio & Ambra / Ivory & Amber
16	Avorio & Oro / Ivory & Gold
17	Avorio & Verde Chiaro / Ivory & Light Green
18	Avorio & Verde Scuro / Ivory & Dark Green
19	Azzurro / Sky-Blue/Azure
20	Bianco / White
21	Bluino / Light Blue/Bluino
22	Blu / Blue
23	Cristallo Trasparente / Transparent Crystal
24	Multicolore / Multicoloured
25	Nero / Black
26	Nero & Oro / Black & Gold
27	Ocra / Ochre
28	Oro / Gold
29	Rosa / Rose
30	Rosso / Red
31	Rosso & Oro / Red & Gold
32	Trasparente (Vetro Murano) / Transparent (Murano Glass)
33	Trasparente & Alessandrite / Transparent & Alessandrite
34	Trasparente & Nero / Transparent & Black
35	Trasparente & Oro / Transparent & Gold
36	Trasparente & Rosa / Transparent & Rose
37	Verde Chiaro / Light Green
38	Verde / Green
39	Verde Scuro / Dark Green
40	Alessandrite, Rosa & Trasparente / Alessandrite, Rose & Transparent
41	Ametista & Rosa / Amethyst & Rose
42	Nero & Argento / Black & Silver
43	Blu & Oro / Blue & Gold
44	Ametista & Trasp. / Amethyst & Transparent
45	Arg. Luc. Incam. Trasp.Luc. / Glossy Silver hooded by Glossy Transparent
46	Arg. Luc. Incam Ross Luc. / Glossy Silver hooded by Glossy Red
47	Arg. Luc. Incam Amb.Luc. / Glossy Silver hooded by Glossy Amber
48	Arg. Sat. Incam. Trasp.Luc. / Polished Silver hooded by Glossy Transparent
49	Arg. Sat. Incam. Rosso Luc. / Polished Silver hooded by Glossy Red
50	Arg. Sat. Incam. Amb.Luc. / Polished Silver hooded by Glossy Amber
51	Arg. Sat. Incam. Trasp. Sat. / Polished Silver hooded by Polished Transparent
52	Rosso & Oro Incam. Trasp. Luc. / Red & Gold hooded by Glossy Transparent
53	Arg. Luc. & Amb Incam.Trasp.Luc. / Glossy Silver
54	Fumè & Trasp. / Fumè & Transparent
55	Fumè / Fumè
56	Trasp. & Rosso / Transparent & Red
57	Oro Bordi Neri / Gold with Black Rims
58	Rosso & Nero / Red & Black
59	Blu & Argento / Blue & Silver
60	Trasp. & Blu / Transparent & Blue
61	Ametista & Oro / Amethyst & Gold
62	Ambra & Blu / Amber & Blue

63	Iride / Iride
64	Ametista & Ambra / Amethyst & Amber
65	Opalino / Opaline
66	Ametista & Argento / Amethyst & Silver
67	Alessandrite & Ametista / Alessandrine & Amethyst
68	Azzurro & Oro / Sky-Blue & Gold
69	Ambra Chiaro & Argento & Trasp. / Light Amber & Silver & Transparent
70	Nero & Avventurina / Black & Avventurina
71	Bianco & Nero / White & Black
72	Bianco & Celeste Opalino / White & Pale Opaline Blue
73	Nero & Iride / Black & Iride
74	Bianco & Rosa / White & Rose
75	Ambra & Iride / Amber & Iride
76	Celeste Opalino / Pale Opaline Blue
77	Alex & Oro & Rosso / Alessandrite & Gold & Red
78	Trasp. & Verde / Transparent & Green
79	Alex & Ametista & Rosa / Alessandrine & Amethyst & Rose
80	Blu & Verde / Blue & Green
81	Argento & Rosso / Silver & Red
82	Alex & Rosa / Alessandrine & Rose

**Codice COLORI FIORI di VETRO**  
**Code MURANO GLASS FLOWER COLOURS**

A0	F.V. Ambra / Amber G.F.
A1	F.V. Ambra & F.V. Rosso / Amber G.F. & Red G.F.
A2	F.V. Bluino / Light Blue/Bluino G.F.
A3	F.V. Rosa / Rose G.F.
A4	F.V. Rosso / Red G.F.
A5	F.V. Trasparente / Transparent G.F.
B0	FV Grande Oro / Rosa - Big Gold / Rose GF
C1	FV Edera / Chicco Rosa / Azzurro - Rose / Sky Blue Ivy / Grain GF
C2	FV Edera / Chicco Nero / Ambra - Black / Amber Ivy / Grain GF
F1	FV Coppo / Gemma Ametista - Coppo / Gem Amethyst GF
F2	FV Coppo / Gemma Opalino - Coppo / Gem Opaline GF
P1	FV Edera / Peperoncino Rosso - Ivy / Red Chili Pepper GF

**Codice COLORI FIORI di CONTERIA**  
**Code MURANO GLASS BEAD FLOWER COLOURS**

D0	F.P. Ambra / Rosso / Amber / Rose G.B.F.
D1	F.P. Nere / Oro / Black / Gold G.B.F.
D2	F.P. Rosa / Oro / Rose / Gold G.B.F.
D3	F.P. Rosso / Oro / Red / Gold G.B.F.
D4	F.P. Argento/Oro / Silver / Gold G.B.F.
D5	F.P. Rosse / Oro & F.P. Nere / Oro / Red/Gold G.B.F. & Black / Gold G.B.F.
D6	FP Nere / Oro & FP Argento/Oro - Black / Gold G.B.F. 6 Silver / Gold G.B.F.
D7	FP Alessandrite - Alessandrite G.B.F.
D8	FP Alessandrite & FP Argento/Oro - Alessandrite G.B.F. & Silver / Gold G.B.F.

**Codice COLORI FIORI VETRO e FIORI PERLE Combinati**  
**Code Combined MURANO GLASS & BEAD FLOWERS COLOURS**

G0	F.V. Ambra / Amber G.F & F.P. Ambra / Rosso / Amber / Rose G.B.F.
G1	F.V. Ambra / Amber G.F & F.P. Nere/Oro / Black / Gold G.B.F.
G3	F.V. Ambra / Amber G.F & F.P. Rosso / Oro / Red / Gold G.B.F.
G4	F.V. Ambra / Amber G.F & F.P. Argento / Oro / Silver / Gold G.B.F.
G5	F.V. Ambra & F.V. Rosso / Amber G.F. & Red G. & F.P. Ambra / Rosso / Amber / Rose G.B.F.
G8	F.V. Ambra & F.V. Rosso / Amber G.F. & Red G.F. & F.P. Rosso / Oro / Red / Gold G.B.F.
H2	F.V. Bluino / Light Blue / Bluino G.F. & F.P. Rosa / Oro / Rose / Gold G.B.F.
H4	F.V. Bluino / Light Blue/Bluino G.F. & F.P. Argento / Oro / Silver / Gold G.B.F.
H6	F.V. Rosa / Rose G.F. & F.P. Nere / Oro / Black / Gold G.B.F.
H7	F.V. Rosa / Rose G.F. & F.P. Rosa / Oro / Rose / Gold G.B.F.
H9	F.V. Rosa / Rose G.F. & F.P. Argento / Oro / Silver / Gold G.B.F.
I0	F.V. Rosso / Red G.F. & F.P. Ambra / Rosso / Amber / Rose G.B.F.
I1	F.V. Rosso / Red G.F & F.P. Nere / Oro / Black / Gold G.B.F.
I3	F.V. Rosso / Red G.F & F.P. Rosso / Oro / Red / Gold G.B.F.
I5	F.V. Trasparente / Transparent G.F. & F.P. Ambra / Rosso / Amber / Rose G.B.F.
I6	F.V. Trasparente / Transparent G.F. & F.P. Nere / Oro / Black / Gold G.B.F.
I7	F.V. Trasparente / Transparent G.F. & F.P. Rosa / Oro / Rose / Gold G.B.F.
I8	F.V. Trasparente / Transparent G.F. & F.P. Rosso / Oro / Red / Gold G.B.F.
I9	F.V. Trasparente / Transparent G.F. & F.P. Argento / Oro / Silver / Gold G.B.F.

**Codice Codifica TIPI PARALUMI**  
**Code SHADE TYPE Code**

Cil	Cilindrico con Intreccio / Cylindrical w / Crossed Plissé
CIP	Cilindrico Plissé / Cylindrical Plissé
CIS	Cilindrico Semplice / Simple Cylindrical
COF	Conico Faldoncino / Conical w / Folds
COI	Conico con Intreccio / Conical w / Crossed Plissé
COP	Conico Plissé / Conical Plissé
COS	Conico Semplice / Simple Conical

FIP	Fiorentina Plissé / Fiorentina Plissé
FIS	Fiorentina Semplice / Simple Fiorentina
GOP	Gonnellina Plissé / Gonnellina Plissé
OAP	Ovale Aperto Plissé / Open Oval Plissé
OAS	Ovale Aperto Semplice / Simple Open Oval
OBP	Ovale Barocco Plissé / Baroque Oval Plissé
OBS	Ovale Barocco Semplice / Simple Baroque Oval
OCF	Ovale Chiuso Plissé / Closed Oval Plissé
OCS	Ovale Chiuso Semplice / Simple Closed Oval
ONP	Onda Plissé / Wave Plissé
ONS	Onda Semplice / Simple Wave
PAP	Parigi Plissé / Parigi Plissé
PAS	Parigi Semplice / Simple Parigi
PGP	Pagoda Plissé / Pagoda Plissé
PGS	Pagoda Semplice / Simple Pagoda
QCP	Quadrato Conico Plissé / Square Conical Plissé
QCS	Quadrato Conico Semplice / Simple Square Conical
QDP	Quadrato Diritto Plissé / Straight Square Plissé
QDS	Quadrato Diritto Semplice / Simple Straight Square
RCP	Rettangolare Conico Plissé / Rectangular Conical Plissé
RCS	Rettangolare Conico Semplice / Simple Rectangular Conical
RDP	Rettangolare Diritto Plissé / Straight Rectangular Plissé
RDS	Rettangolare Diritto Semplice / Simple Straight Rectangular
SAG	Sagomato / with Irregular Shape
SPI	Spicchi / Spicchi
STP	Strega Plissé / Strega Plissé
STS	Strega / Simple Strega
VAS	Ventola Semplice con Angoli / Simple Ventola w / Angoli
VDN	Ventola Diritta Plissé con Nodo / Straight Ventola Plissé w / Knot
VDP	Ventola Diritta Plissé / Straight Ventola Plissé
VDS	Ventola Diritta Semplice / Simple Straight Ventola
VSN	Ventola Settecento Plissé con Nodo / 17th Cent. Ventola Plissé w / Knot
VSP	Ventola Settecento Plissé / 17th Cent.Ventola Plissé
VSS	Ventola Settecento Semplice / Simple 17th Cent. Ventola
WAN	Ventola con Voluta & Angoli Plissé con Nodo / Ventola w / Voluta & Angoli Plissé w / Knot
WAP	Ventola con Voluta & Angoli Plissé / Ventola w / Voluta & Angoli Plissé
WAS	Ventola con Voluta & Angoli Semplice / Simple Ventola w / Voluta & Angoli

## CONDIZIONI DI VENDITA

### 1. Applicazione

Le presenti Condizioni Generali di Vendita costituiscono, unitamente a quelle espressamente pattuite dalle parti al momento della conclusione del contratto, l'intera ed esclusiva disciplina del rapporto contrattuale in essere tra Patavium srl (di seguito "Società") e l'acquirente (di seguito "Cliente") salvo quanto eventualmente concordato per iscritto successivamente alla conclusione del contratto. Le stesse sono da intendersi sostitutive di ogni diverso accordo precedentemente intercorso fra le parti e dunque prevalenti su ogni termine o condizione contenuta o riportata nell'ordine del Cliente o nella corrispondenza, o implicite nella prassi commerciale o menzionate in corso di trattativa.

### 2. Termine di Pagamento

I Termini di pagamento sono perentori e vengono concordati alla definizione dell'ordine e riportati nella conferma scritta da parte della Società. Il pagamento delle fatture deve essere effettuato per l'intero importo, senza alcuna detrazione, compensazione o qualsiasi altra eccezione. L'eventuale esenzione dall'IVA da parte del Cliente deve essere espressamente specificata nell'ordine e deve essere adeguatamente comprovata. Qualsiasi proroga del credito concessa al Cliente può essere modificata o revocata in qualsiasi momento. La Società si riserva il diritto di sospendere l'evasione di ordini ancora in essere qualora risultassero delle fatture scadute non saldate. Nel caso in cui i pagamenti non siano effettuati nei tempi concordati, la Società si riserva il diritto di applicare un interesse di mora pari al "Prime Rate" pubblicato ne "Il Sole 24 Ore" del giorno di fatturazione, maggiorato di 4 punti percentuali.

### 3. Merce e Prezzi

I prezzi della merce sono da intendersi pattuiti in relazione a quanto risultante nel listino della Società al momento del perfezionamento del contratto. La Società, fino al perfezionamento del contratto, ha il diritto, in qualsiasi momento e senza preavviso, di aggiornare e/o modificare i prezzi e/o di ritirare qualsiasi merce dalla gamma di prodotti offerti. Salvo diversa pattuizione scritta, i prezzi indicati dalla Società si intendono per spedizione franco deposito della Società stessa in imballo originale, IVA esclusa. L'IVA sarà applicata al tasso vigente alla data di fatturazione.

### 4. Ordini

Il Cliente deve effettuare gli ordini per iscritto, su carta intestata dell'azienda, ed inoltrarli via fax, e-mail o posta in originale. L'ordine deve essere timbrato e firmato dal Cliente nella persona munita di relativo potere, e sarà soggetto ad accettazione scritta da parte della Società tramite Conferma d'Ordine indicante prezzi e condizioni particolari di fornitura e pagamento. Non è necessario un quantitativo minimo di ordine. Tutta la merce verrà fornita e fatturata a pezzi o in misurazione metriche. Se l'ordine viene trasmesso a seguito ed in base a un'offerta precedentemente formulata dalla Società, i prezzi indicati nell'offerta sono da intendersi vincolanti per il solo periodo di efficacia della stessa. Al fine di assicurare una tempestiva e corretta spedizione è necessario utilizzare i numeri di Codice Articolo della Società indicati in maniera chiara nel catalogo, o su precedenti Conferme d'Ordine, Fatture Proforma o Fatture di Vendita. Il Cliente provvederà esplicitamente a specificare in un'eventuale conferma scritta la natura di mera "conferma di ordine già esistente" precedentemente inoltrato in forma scritta o non scritta, ciò al fine di evitare duplicazioni di ordini. In caso contrario, il Cliente sarà ritenuto responsabile per qualsiasi conseguente duplicato di detto ordine esistente e pagherà alla Società un importo per la transazione pari al venti per cento netto di listino della merce compresa nell'ordine duplicato, oltre a tutte le spese di trasporto per la consegna e la conseguente restituzione della merce alla Società.

### 5. Spese di Consegna

La merce viene consegnata "ex-fabbrica", pertanto la Società non applica spese per la consegna. Nel caso in cui tra la

Società ed il Cliente fosse stata concordata una modalità di consegna diversa, la Società aggiungerà le spese del trasporto sulla Conferma d'Ordine, Fattura Proforma o Fattura di vendita emesse al Cliente. La Società non è in alcun modo responsabile per eventuali ritardi causati dalle imprese di trasporto rispetto alle previsioni di ritiro della merce e la successiva consegna al Cliente.

### 6. Consegna

Tutte le ore e date di consegna indicate in qualsiasi preventivo, riscontro di ordine o altro documento sono approssimative e non possono in ogni modo considerarsi termini essenziali.

### 7. Forza Maggiore

Qualora l'esecuzione degli ordini sia ritardata o impedita da causa non imputabile alla Società ivi compresa l'impossibilità della stessa di procurarsi i servizi, materiali od articoli necessari per l'adempimento del contratto, o di procurarsi i medesimi solo a prezzi maggiorati, la Società potrà recedere dagli ordini o ritardare l'evasione degli stessi. Resta inteso che nel caso di ritardo la Società comunicherà lo stesso al Cliente e questi potrà esercitare diritto di recesso dall'ordine senza null'altro pretendere dalla Società. In ogni caso, l'inadempimento o il ritardo per le ragioni suddette ed in genere per causa non imputabile alla Società esclude qualsiasi forma di responsabilità della stessa, ivi compreso ogni preteso diritto di risarcimento del danno.

### 8. Rifiuto o mancata Accettazione della Consegna

Se il Cliente rifiuta o non accetta la consegna della merce presentata conformemente al contratto, o non adotta le azioni necessarie per rendere possibili la consegna e/o la spedizione della stessa, la Società si riserva il diritto di risolvere il contratto con effetto immediato e di ottenere dal Cliente il rimborso di tutte le perdite e dei costi addizionali nei quali sia incorsa a seguito del rifiuto o della mancata accettazione.

### 9. Ispezione

Sarà responsabilità del Cliente ispezionare e controllare tutta la merce immediatamente, e comunque non oltre otto giorni, al momento della consegna della stessa, al fine di verificare colore, rifiniture, misure, stato, precisione e, in genere, la corrispondenza della merce consegnata a quella ordinata. Il Cliente è ritenuto responsabile per l'ispezione ed il controllo della merce anche nel caso in cui, su richiesta espressa dello stesso, questa venga consegnata a terzi. Il Cliente è tenuto a comunicare per iscritto alla Società, entro otto giorni dalla consegna, vizi riscontrati e riscontrabili ad un primo esame, o qualsiasi altro reclamo in relazione ai prodotti. Nel caso in cui il cliente non effettui la comunicazione di cui sopra, i prodotti saranno considerati definitivamente accettati e conformi a quanto stabilito dal contratto di vendita.

### 10. Rischio e Diritto

La merce rimarrà di sola ed assoluta proprietà della Società fino a quando il Cliente non avrà pagato alla Società l'intero importo concordato. Ogni rischio sulla medesima merce graverà invece interamente sul Cliente dal momento del ritiro della stessa o dalla presa in custodia da terzi indicati per suo conto. Il Cliente dovrà assicurare la merce in modo adeguato. Fino al momento in cui avverrà il pagamento, il Cliente sarà esclusivamente depositario della merce per conto della Società, in un ruolo fiduciario, e custodirà la stessa in modo tale che la si possa identificare come proprietà della Società. La Società si riserva il diritto immediato di riacquistare il possesso di qualsiasi merce sulla quale continui ad avere il diritto come summenzionato, e successivamente di rivendere la stessa. A tale fine il Cliente riconosce alla Società il diritto di visitare i suoi locali, con o senza veicolo, durante le normali ore di lavoro. Questo diritto continuerà a sussistere anche in caso di risoluzione del contratto dovuta a qualsiasi motivo e senza costituire pregiudizio per qualsiasi altro diritto maturato dalla Società.



## 11. Responsabilità

La Società non sarà responsabile nei confronti del Cliente:

- (I) per una differenza di quantitativo tra merce consegnata rispetto a quella ordinata, salvo il tempestivo reclamo inviato dal Cliente entro otto giorni dalla data della consegna della merce.
- (II) per mancata consegna, danno o perdita della merce, o di qualsiasi sua parte, durante il trasporto, (quando la merce viene trasportata dai veicoli della Società o da un corriere per conto della Società) salvo il tempestivo reclamo inviato dal Cliente entro otto giorni dalla data della consegna.
- (III) per difetti della merce causati da usura, condizioni insolite di immagazzinamento, imballaggio non idoneo al trasporto, uso, o applicazione di qualsiasi trattamento o processo dopo l'acquisto (incluso, ma non ad esso limitato, l'acquisto di qualsiasi tipo di spray, colore o trattamento anti-fiamma) o qualsiasi altro atto, modifica o negligenza del Cliente o di terzi;
- (IV) per altri difetti della merce non comunicati alla Società entro otto giorni dalla consegna, ed in qualsiasi caso prima che detta merce venga utilizzata o venduta a terzi.
- (V) per qualsiasi perdita, danno o lesione diretta o indiretta risultante da lavorazione difettosa del materiale o altro, in qualsiasi modo ciò avvenga, indipendentemente dal fatto che sia stata causata o meno dalla negligenza della Società, dei suoi dipendenti o agenti.

Quando la responsabilità viene accettata dalla Società conformemente al paragrafo precedente l'unica obbligazione della Società sarà, a sua discrezione, rettificare qualsiasi ammanco o mancata consegna e/o, come opportuno, sostituire o riparare qualsiasi merce che risulti danneggiata o difettosa e/o rifondere il Cliente del costo di tale merce. La responsabilità globale della Società verso il Cliente, per negligenza, violazione del contratto, false dichiarazioni o altro, non supererà in nessuna circostanza il costo della merce difettoso, danneggiata o non consegnata che darà luogo a questa responsabilità, determinata dal prezzo netto fatturato al Cliente per detta merce, in qualsiasi evenienza o serie di occorrenze. I prezzi della merce stabiliti dalla Società tengono conto dei limiti di responsabilità sopra indicati. Il Cliente può, mediante avviso scritto, richiedere alla Società di accordarsi su un limite superiore di responsabilità a condizione che si possa ottenere una copertura assicurativa. Le presenti condizioni generali delineano l'intero ambito della responsabilità della Società riguardo ai prodotti, con esclusione di qualsiasi altra garanzia, condizione e termine espressi o impliciti, previsti dalla normativa nazionale ed internazionale, in ordine alla qualità o alla idoneità per qualsiasi uso particolare dei prodotti. Rimane salva l'applicazione delle garanzie inderogabili per legge.

## 12. Resi

- (I) Per la riconsegna dei prodotti alla Società dovranno essere applicate le specifiche condizioni indicate di volta in volta e per iscritto dall'operatore della Società.
- (II) La Società non accetta la restituzione di nessuna merce in cambio dell'ottenimento di credito, salvo un precedente accordo scritto intercorso fra le parti.
- (III) Dopo aver ricevuto dalla Società l'autorizzazione alla restituzione dalla merce, sarà cura del Cliente riconsegnare o far riconsegnare al reparto di controllo della Società medesima i prodotti perfettamente integri ed adeguatamente imballati entro ventotto giorni dalla data di fattura in porto franco. Tutte le parti eventualmente aggiunte dal Cliente ai prodotti dovranno essere rimosse prima della restituzione. La Società sarà autorizzata, in caso contrario, a rimuovere dal prodotto tutte le parti aggiunte senza nulla riconoscere e/o restituire al Cliente.
- (IV) I prodotti sono riconsegnati a rischio del Cliente ed è pertanto da intendersi gravante sullo stesso ogni responsabilità per perdita o danneggiamento della merce.
- (V) La Società si riserva il diritto di applicare un addebito pari al trenta per cento del prezzo della fattura per i resi inferiori al valore di 1000,00 Euro, ed un addebito pari al venti per cento del prezzo della fattura per i resi superiori al valore di 1000,00 Euro. I resi inferiori al valore di 300,00 Euro non saranno accettati.

## 13. Accostamento di Colore e di Rifinitura

La Società non garantisce e non si assume alcuna responsabilità in merito alla conformità del colore, tonalità e rifiniture, della merce consegnata al colore, tonalità e rifiniture dei campioni mostrati in qualsiasi pubblicità, campionario, campionatura, catalogo, o altrove.

Fermo quanto stabilito al precedente capoverso, nel caso in cui il Cliente richieda un accostamento accurato, lo stesso dovrà consegnare alla Società un campione di colore, tonalità o rifinitura richiesti, oppure chiedere alla Società di fornire un campione del suo stock attuale, se esistente.

## 14. Campioni

I campioni di merce verranno spediti dalla Società via posta o corriere previo accordo tra le parti.

I campioni in visione restano di proprietà della Società e sono da restituire entro trenta giorni salvo diversa autorizzazione scritta dalla Società.

Nel caso in cui il Cliente non restituisca i suddetti campioni in visione entro i 30 giorni, o comunque entro la data stabilita, la Società si riserva il diritto di addebitarli al costo in vigore alla data di consegna.

## 15. Insolvenza e Inadempienza

Se il Cliente si impegna in un atto di concordato o entra in bancarotta o si accorda con i suoi creditori, o se viene emesso un provvedimento cautelare di sequestro del patrimonio contro di lui o (in veste di società) viene emesso un ordine o viene deliberata una risoluzione per la liquidazione della sua azienda (per motivi diversi dalla fusione o incorporazione precedentemente approvata per iscritto dalla Società) o se viene nominato un custode giudiziario dei beni del Cliente o della sua azienda, o se insorgessero le circostanze necessarie affinché il tribunale o un creditore richiedano la nomina di un custode giudiziario o di un amministratore, o conferiscano al tribunale il diritto di emettere un ordine di liquidazione, o se il Cliente intraprende o subisce un'azione simile od analoga quale conseguenza di debito o commette qualsiasi violazione di questo o qualsiasi altro contratto tra la Società e il Cliente, la Società può, senza pregiudicare nessun degli altri suoi diritti, fermare tutta la merce in transito e/o sospendere ulteriori consegne e/o recedere dal contratto mediante notifica scritta al cliente.

## 16. Rinuncia di Diritti

La mancanza, da parte della Società, di esercizio o applicazione di qualsiasi diritto previsto dal presente atto, non costituisce rinuncia alcuna.

## 17. Notifiche

Qualsiasi notifica menzionata nel presente atto verrà considerata debitamente comunicata se inviata a mezzo lettera raccomandata, fax, corriere o qualsiasi altro mezzo di comunicazione che assicuri la prova e la data di ricevimento della comunicazione.

## 18. Legge Vigente e Giurisdizione

Il contratto verrà regolato e interpretato conformemente alle leggi italiane con esclusione delle convenzioni internazionali, e le parti menzionate nel presente atto si sottomettono alla giurisdizione esclusiva dei tribunali italiani.

## 19. Foro Competente

Il Foro di Padova, Italia, sarà competente in via esclusiva per qualunque controversia nascente dall'applicazione delle condizioni generali di vendita ai rapporti commerciali intercorrenti tra la Società ed il Cliente.

## 20. Diritti d'Autore, Diritti Industriali e Brevetti

Pataviumart® è un marchio registrato della Pataviumart srl. Tutti i prodotti della Società sono protetti da diritti d'autore, da diritti industriali, da leggi italiane, comunitarie ed internazionali. Sono severamente vietate la parziale o completa pubblicazione, trasmissione, divulgazione, copia o qualsiasi altra duplicazione di prodotti, dati, testi, grafici, fotografie, immagini ecc. senza esplicita autorizzazione scritta rilasciata dalla Pataviumart srl. Tutti i diritti sono riservati.

# TERMS & CONDITIONS OF SALES & TRADING

## 1. Application

The following Terms & Conditions of Sales & Trading constitute, together with those expressly fixed at the moment of the conclusion of the contract of sales, the entire existing contractual relation between Pataviumart srl. (the "Company") and any purchaser (the "Customer") and substitute divergent agreements except for agreements signed by a legal representative of the company which have to be written on the Company's letter-headed paper. These conditions apply to all sales of goods by Pataviumart srl. to any purchaser and shall apply in place of and prevail over any terms or conditions contained or referred to in the Customer's order or in correspondence or elsewhere or implied by trade custom practice or course of dealing and any purported provision to the contrary are hereby excluded or extinguished.

## 2. Terms of Payment

Terms are peremptory and are agreed upon when the order is received by the Company, which, however, will indicate such terms on its respective order confirmation. Payments of invoices shall unless otherwise agreed in writing by the Company be made in full without any deduction, set-off or any further sort of request. Any exemption of V.A.T. of the Customer has to be expressly indicated on the order and must be proved adequately. Any extension of credit allowed to the Customer may be changed or withdrawn at any time. If in the opinion of the Company the credit-worthiness of the Customer shall have deteriorated prior to delivery the Company may require full or partial payment of the price prior to delivery. The Company reserves the right to hold back any order pending if an account is overdue for payment. In the event that the payments are not made within the agreed date/dates, the Company reserves the right to charge delay interests totalling the "Prime Rate" published on "Il Sole 24 Ore" on the date of invoice marked up by 4 per cent.

## 3. Goods and Prices

The prices payable for the goods shall be those contained in the Company's pricelists, therefore current at the time of the fulfilment of the contract. The Company shall have the right at any time without prior notice to up-date and/or change its prices, to make any technical and aesthetic changes suitable to improve the products and/or to withdraw any goods from the range of products offered. If not specified differently, all the prices are "ex-factory" from the Company, goods packed to be shipped. All prices exclude V.A.T. which will be added according to the rate applicable on the date of invoicing.

## 4. Orders

Orders must be sent to the Company in writing on Client's letter-headed paper by either fax, e-mail or post. The latter has to be an original order document; copies are not accepted by post. The order must be rubber-stamped and signed by the person in charge of the purchase department in the Customer's company. There is no minimum order. All orders will be supplied and invoiced with metric measurements or apiece. Orders must be confirmed in writing by the Customer and are in all cases subject to acceptance by the Company, which will send a written order confirmation to the Customer. If the order refers to an offer previously made by the Company, the conditions, terms and prices of which are still applicable, the Company will confirm the prices of the offer. In case the offer is not applicable anymore, the Company will charge the current prices for all goods regardless of the prices quoted on the offer. In all cases shall the Company quote on any order confirmation the respective prices, payment and delivery terms and conditions. In order to guarantee a prompt and correct delivery the Customer must on all orders clearly indicate the Company's Article Code which is used by the Company in its catalogues, samples, order confirmations, proforma invoices or sales invoices. No additional information or descriptions must be added by the customer unless they are absolutely necessary for a correct identification of the ordered article. If any confirmation, written or oral, of an order by the Customer does not expressly

and prominently state that it is a confirmation of an existing order, the Customer shall be responsible for any consequent duplication of the said existing order and shall pay the Company a handling charge equal to twenty per cent of the net list price of the goods comprised the duplicate order plus all carriage costs arising from the delivery or consequent return of the said goods to the Company.

## 5. Delivery Charge

Goods are delivered "ex-factory"; therefore, there are no transport costs. In case the Company and the Customer agreed on different delivery terms and conditions, the Company will add the transport costs to the order confirmation, proforma invoice or sales invoice and charge the Customer consequently. The Company and its suppliers are under no circumstances liable for any delays caused by the transport agent with regard to the loading and the delivery of the Customer's goods.

## 6. Delivery

Any time or date for delivery is approximate only and not of any contractual effect and the Company shall not be under any liability in respect of any failure to deliver at any particular time or date. Any date and time mentioned in any acknowledgement of order or elsewhere can, under no circumstance, be considered essential.

## 7. Force Majeure

In case it is impossible for the Company to carry out an order because of obstacles or hindrances beyond any reasonable control of the Company including the Company's impossibility to obtain the necessary services, materials or articles to carry out the order, except for price increases, the Company may delay the production of the goods and, once informed the Customer about the delay, the latter has the right to cancel the total or a part of his order without being charged any amount or compensation by the Company. The Company shall in no case be liable for this delay or the cancellation or any other case which makes it impossible for the Company to carry out the order. The Company shall under no circumstance be liable to compensation.

## 8. Refusal or Failure to take Delivery

If the Customer refuses or fails to take delivery of goods tendered in accordance with the contract or fails to take any action necessary on its part for delivery and/or shipment of the goods the Company shall be entitled to terminate the contract with immediate effect and recover from the Customer any loss and additional costs incurred as a result of such refusal or failure.

## 9. Inspection

It shall be the responsibility of the Customer to inspect all goods immediately on delivery and in any event within the subsequent eight days. The Customer must check the colour, the finishes, the dimensions, the state and accuracy of the goods and ensure that the goods correspond to those ordered. The Customer's said responsibility shall not be in any way diminished or extinguished in the case of goods which are delivered to a third party on the instruction of the Customer. The Customer must notify the Company in writing within eight days after delivery noted and noticeable faults and damages or any other claim regarding the goods. In case the Customer does not notify as aforesaid, the goods are considered definitely accepted and corresponding to the sales contract. Hidden or not apparent faults or damages may be communicated to the Company within the first year after delivery. Such hidden or not apparent faults or damages must, however, be communicated in writing to the Company within eight days after they had been noted.

## 10. Risk and Title

The goods shall remain the sole and absolute property of the Company as legal and equitable owner until such time as the Customer shall have paid in full to the Company the agreed

price therefore. Until such payment the Customer shall be in possession of the goods solely as bailee for the Company and in a fiduciary capacity and shall insure them accordingly and store the goods in such a way as to enable them to be identified as the property of the Company. After delivery or acceptance in custody of the goods even by a third party on the instruction of the Customer, any risk related to such goods shall entirely be on Customer's side. The Company reserves the immediate right of re-possession of any goods to which it has retained title as aforesaid and thereafter to re-sell the name and for this purpose the Customer hereby grants an irrevocable right and license to the Company's servants and agents to enter upon all or any of its premises with or without vehicles during normal business hours. This right shall continue to subsist not with standing the termination of the contract for any reason and is without prejudice to any accrued rights of the Company thereunder or otherwise. This access must be granted to allow the withdrawal of the goods for which the payment to the Company is overdue. Any withdrawal of goods does not entail that the Company retreats from the existing contract.

#### 11. Liability

The Company shall not be liable to the Customer:

- (I) for shortage in quantity delivered unless the Customer notifies the Company of any claim for short delivery within fourteen days of the date of the Company's invoice for the goods;
- (II) for non-delivery of the goods or damage to or loss of the goods or any part thereof in transit (where the goods are carried by the Company's own transport or by a carrier on behalf of the Company) unless the Customer shall notify the Company of such claim within fourteen days of the date the Company's invoice for the goods and in case of goods all or any part of which are received damaged, unless the Customer shall sign for them as damaged and shall immediately notify the Company of the damage in writing;
- (III) for defects in the goods caused by the fair wear and tear, abnormal conditions or storage or use or the application of any treatment or process whatsoever to the goods after purchase (including, without limitation, any spray, colouring or flame proofing) or any act, neglect or default of the Customer or of any third party;
- (IV) for other defects in the goods unless notified to the Company within fourteen days of the date of the Company's invoice for the goods and in any event before the goods are passed on or sold to a third party;
- (V) for any loss, damage or injury direct or indirect resulting from defective material, faulty workmanship or otherwise, howsoever arising and whether or not caused by the negligence of the Company its employees or agents SAVE THAT the Company shall accept liability for death or personal injury caused by the negligence of the Company.

Where liability is accepted by the Company the Company's obligation shall be at its option to make good any shortage or non-delivery and/ or as appropriate to replace or repair any goods found to be damaged or defective and/or to refund the costs of such goods to the Customer. The Company's aggregate liability to the Customer whether for negligence, breach of contract, misrepresentation or otherwise shall in no circumstances exceed the costs of the defective, damaged or undelivered goods which give rise to such liability as determined by the net price invoiced to the Customer for the said goods in respect of any occurrence or series of occurrences.

The Company's prices are determined on the basis of the limits of liability set out in this Condition. The Customer may by written notice to the Company request the Company to agree a higher limit of liability provided insurance cover can be obtained therefore. The aforesaid and following Conditions cover the entire limits of liability of the Company with respect to the goods and exclude any other liability, warranty or conditions explicit or implicit fixed by law referring to quality or qualification of any particular use of the goods, save those which by force of law cannot not be abrogated.

#### 12. Returns

- (I) For all returns of goods to the Company the specific condition of the Company must be applied.
- (II) No goods can be accepted back for credit unless the Company's prior written agreement for their return has been obtained.
- (III) After having obtained the authorization for returning the goods it is the Customer's responsibility to return the goods to the Company within twenty-eight days from invoice date. The goods must be adequately packed, intact and protected for transport and returned to the control department of the Company on Customer's expenses within twenty-eight days after invoice date. Any added parts must have been removed completely before returning the goods. Failing this the Company will be authorized to remove all added parts.
- (iv) The Customer bears all risks related to the returning of the goods and therefore will be liable for any loss, shortage or damage of the goods or the added parts returned together with such goods.
- (v) The Company reserves the right to impose a thirty per cent handling charge on the invoice price of returns with an invoiced value below 1000,00 Euro and a twenty per cent handling charge on the invoice price of returns with an invoiced value above 1000,00 Euros. Returns with an invoiced value below 300,00 Euros will not be accepted by the Company.

#### 13. Colour and Finish Matching

All Conditions, warranties and representations expressed or implied by statute common law or otherwise that the colours, shades or finishes shall match accurately the colour, shade or finish of any sample or cutting or of goods shown in any advertisement, pattern book, display card, catalogue or elsewhere are hereby excluded. Without prejudice to paragraph (i) of this Condition, in the event that the Customer requires an accurate match, the Customer shall either deliver a sample or cutting of the required colour, shade or finish to the Company or ask the Company to supply a colour, shade or finish sample from its current stock, if the latter is held.

#### 14. Samples

Samples will be sent by post or carrier on application to the Company. The samples on approval remain Company's property as per Condition 10 of these Terms & Conditions of Sales & Trading and not returned to the Company within thirty days or within the agreed period will be charged at the price per sample ruling at the date of despatch.

#### 15. Insolvency and Default

If the Customer enters into a deed of arrangement or commits an act of bankruptcy or compounds with his creditors or if a receiving order is made against him (being a company) an order is made or a resolution is passed for the winding up of the Customer (otherwise than for the purposes of amalgamation or reconstruction previously approved in writing by the Company) or if a receiver is appointed of any of the Customer's assets or undertaking or if circumstances arise which entitle the Court or a creditor to appoint a receiver or manager or which entitle the Court to make a winding-up Order or if the Customer takes or suffers any similar or analogous action in consequence of debt or commits any breach of this or any other contract between the Company and the Customer the Company may without prejudice to any of its other rights stop any goods in transit and/or suspend further deliveries and/or by notice in writing to the Customer determine the contract.

#### 16. Waiver

Failure by the Company to exercise or enforce any rights hereunder shall not be a waiver of any such right nor operate so as to bar the exercise or enforcement thereof at any time or times thereafter.

#### 17. Notice

Any notice hereunder shall be deemed to have been duly given if

sent by prepaid first class post, telex, fax or by any other means of communication to the party concerned if proof and date of delivery are guaranteed.

#### 18. Governing Law

The contract shall be governed by and construed in accordance with the Italian Law and the parties hereby submit to the jurisdiction of the Italian Law. Any international conventions are hereby excluded.

#### 19. Place of Jurisdiction

The Court of Padova, Italy is the only and exclusive place of jurisdiction for any dispute related to the application and interpretation of the General Terms and Conditions of Sales and Trading between the Company and the Customer.

#### 20. Trademark Laws & Copyrights

Pataviumart® is a registered trademark of Pataviumart srl. All products of the Company are protected under Italian & International Copyright Laws, trademark laws, industrial laws or otherwise. Any partial or complete publication, transmission, copy or any other duplication of products, data, texts, graphics, photographs, images etc. is strictly forbidden without explicit written consent by Pataviumart srl.

All rights reserved.

## RINGRAZIAMENTI

Lo sviluppo di Pataviumart non sarebbe stato possibile senza l'impegno, gli sforzi ed i sacrifici di alcune persone per noi speciali. La nostra più sentita gratitudine va al nostro amato Adriano Gomiero, il quale sarebbe stato orgoglioso dei risultati ottenuti ma anche entusiasta delle sfide da affrontare, ed a Ines Piccolo, che dedica ancora oggi vita e anima al nostro lavoro quotidiano.

Il loro ottimismo e la loro dedizione sono stati le solide fondamenta della Pataviumart. Vorremmo estendere i nostri sinceri ringraziamenti a Daniela Zorzi, Franco Zannoni, Tiziano Giobbe, Nino Filocamo e Pietro Didonè, stretti collaboratori del nostro team da tanti anni, che sono stati e sono così importanti per la nostra società.

Sappiamo bene che senza lo spirito di gruppo poco avremmo potuto raggiungere. Infine esprimiamo la nostra immensa gratitudine a tutti coloro che in tutto il mondo ci hanno accompagnati nel nostro lungo viaggio nelle vesti di rappresentanti, distributori, clienti o fornitori.

La loro devozione, il loro impegno e la loro professionalità hanno permesso alla Pataviumart di diventare la società che noi amiamo.

Riserviamo un ringraziamento personale per Erica e Roberto.

Grazie di tutto cuore.

## ACKNOWLEDGMENTS

The development of Pataviumart would have barely been possible without the efforts and the love of a few extraordinary individuals. Our tremendous gratitude goes to our beloved Adriano Gomiero, who would be proud on the obtained results and enthusiastic about the upcoming challenges, and to Ines Piccolo, who still dedicates more than her life and soul to our daily work.

The optimism and dedication of both have been the solid basis for the launch of Pataviumart. Our appreciation is extended to Daniela Zorzi, Franco Zannoni, Tiziano Giobbe, Nino Filocamo e Pietro Didonè who as long-term team members have been so influential to the company's achievements.

We would also like to offer our heartfelt gratitude for the exceptional dedication and devotion shown by Pataviumart's worldwide distributors, representatives, customers and suppliers.

Their devotion and incredible efforts have enabled Pataviumart to evolve into the company it is today.

A special thank-you goes to Erica and Roberto. Thank you all.

## REDAZIONE | EDITORIAL

### Art Direction & Design

Cristian Gomiero  
Mayc R. Letzner  
Simonetta Gomiero

### Layout & Illustrazioni Layout & Illustration

Cristian Gomiero  
Mayc R. Letzner  
Mauro Argenti  
Nicola Vegro

### Fotografia Photography

Nicola Vegro  
Katia Ondedei  
Officine Vegro sas., Italia

### Testi Calligraphy

Mayc R. Letzner

### Stampa & Produzione Produced & Printed

Grafiche Antiga spa  
Crocetta del Montello, Treviso, Italia

# Pataviumart®

Pataviumart srl  
Villa Wollemborg  
Via Aurelia 2  
35010 Loreggia (PD)  
Italia

Tel. +39 049 5790903  
Fax +39 049 9321686  
info@pataviumart.it  
www.pataviumart.it

### Orari Ufficio

Lunedì - Venerdì  
09.00 - 13.00 e 14.00 - 18.00

### Office Hours

Monday-Friday  
09.00 - 13.00 and 14.00 - 18.00

Pataviumart® è un marchio registrato della Pataviumart srl, Italia.  
Swarovski® è un marchio registrato della Swarovski AG, Austria.

Pataviumart® is a registered trademark of Pataviumart srl, Italy.  
Swarovski® is a registered trademark of Swarovski AG, Austria.